

Convection Speed Oven, 24", 22 Function

Series 9 | Contemporary

Stainless Steel



The speed of microwave cooking with the versatility of convection oven technology in a compact companion model, for perfect pairing.

- Generous 1.7 cu ft capacity, with four shelf positions
- A Wired Temperature Sensor precisely monitors cooking in real time
- Guided touchscreen cooking makes it simple to navigate cooking processes
- Wi-Fi enabled and works with the SmartHQ™ app for remote control and notifications

DIMENSIONS

Height	18"
Width	23 7/16"
Depth	22 1/4"

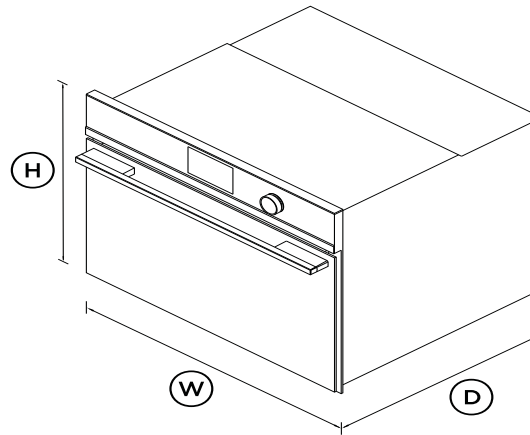

FEATURES & BENEFITS

Cooking flexibility

Choose from 22 functions, including four microwave-only functions, 14 traditional oven functions, and four combination functions, giving you the best microwave and convection oven technology.

Cook with confidence

The 5" screen provides an intuitive guided cooking experience that helps to deliver perfect results, whether you've been

cooking all your life or are just starting out.

Sized to suit

A compact 24" width means this microwave oven can be placed almost anywhere – all companion products can be installed at a convenient height to suit your kitchen design and preference.

Complementary Design

Finished in stylish stainless steel with a polished metal trim, our Contemporary style ovens help you to create a coherent, distinctive aesthetic in your kitchen.

Multi-function flexibility

Each function has been tailored and tested to ensure perfect defrosting, heating and cooking.

Safe And Sound

The CoolTouch door is safe to touch from the outside, protecting your hands and the surrounding cabinetry.

SPECIFICATIONS

Accessories

Chromed shelf runners	•
Glass tray	1
Step down wire shelf	1
Wire shelf	1
Wired temperature sensor	1

Accessories (sold separately)

Matching Trim Kit	TK7630NDX1
-------------------	------------

Capacity







Shelf positions	4
Total capacity	1.7cu ft
Usable capacity	1.3cu ft

<hr/>					
Cleaning		Broil	•	Amperage	23A
Acid resistant graphite enamel	•	Defrost	•	Supply frequency	60Hz
Removable oven door	•	Dehydrate	•	Supply voltage	208-240V
Removable shelf runners	•	Fan forced + Micro (3 levels)	•	<hr/>	
		Fan grill + Micro (3 levels)	•	Product dimensions	
		Grill + Micro (3 levels)	•	Depth	22 1/4"
		Maxi Broil	•	Height	18"
Controls		Number of functions	22	Width	23 7/16"
Adjustable audio and display	•	Pastry Bake	•	<hr/>	
Audio feedback	•	Pizza bake	•	Safety	
Automatic cooking/minute	•	Popcorn	•	ADA compliant	•
Automatic pre-set	•	Quick start	•	Balanced oven door	•
Delay start	•	Rapid proof	•	Control panel key lock	•
Electronic clock	•	Roast	•	CoolTouch door	•
Electronic oven control	•	Roast + Micro (3 levels)	•	Non-tip shelves	•
Food probe	•	Slow cook	•	Safety thermostat	•
Guided cooking by food type	•	True Aero	•	<hr/>	
Halogen lights	•	Vent bake	•	Warranty	
Intuitive touchscreen display	•	Warm	•	Parts and labour	2 years
Multi-language display	UK English, US English,	<hr/>		<hr/>	
Sabbath mode with Star K	•	Performance			
Soft close doors	•	ActiveVent™ system	•	SKU	82674
True convection oven	•	AeroTech™ technology	•	<hr/>	
Turned stainless steel dials	•	Automatic rapid pre-heat	•	The product dimensions and specifications in this page apply to the specific product and model. Under our policy of continuous improvement, these dimensions and specifications may change at any time. You should therefore check with Fisher & Paykel's Customer Care Centre to ensure this page correctly describes the model currently available. Fisher & Paykel Appliances Ltd 2020	
Wi-Fi connectivity	•	Microwave by levels	•	Where applicable:	
		Microwave power	900W	All appliances use energy, and energy usage typically generates carbon emissions. Fisher & Paykel Appliances' In-use Energy Carbon Emissions Estimate indicates	
Functions		Microwave power levels	6		
Aero Bake	•	Temperature range	95 °F - 445 °F		
Aero Broil	•	<hr/>			
Air fry	•	Power requirements			
Bake	•				

carbon emissions from a product's in-use energy. This is calculated either annually or per cycle, using the product's market-specific energy label energy consumption data multiplied by the carbon emissions factor for energy in your country or region.

Our In-use Energy Carbon Emissions Estimate is designed to assist customers in making informed purchasing decisions when comparing different Fisher & Paykel products. For example, a heat pump dryer typically has a lower In-use Energy Carbon Emissions Estimate than a vented dryer.

Other product downloads available at fisherpaykel.com

-  [Service & Warranty](#)
-  [User Guide Microwave Oven EN](#)
-  [User Guide SP](#)
-  [User Guide FR](#)
-  [Installation Guide EN](#)
-  [Data Sheet Convection Speed Oven](#)
-  [Preliminary Specification Guide](#)



A PEACE OF MIND SALE

24 Hours 7 Days a Week Customer Support

T 1.888.936.7872 W www.fisherpaykel.com