

Electric Range 30" - Ceramic Radiant

Series 7 | Contemporary

Stainless Steel



A refined electric range with multiple oven functions for perfect cooking of anything from a large roast to baking bread and pastry.

- Electric radiant cooktop with four cook elements
- Nine oven functions including Roast, Aero™ Pastry with Pizza mode, and Rapid Proof for baking bread
- High-temperature self-cleaning function breaks down food residue for an easy clean

DIMENSIONS

Height	35 3/4 - 37 5/8"
Width	29 7/8"
Depth	25 1/4"

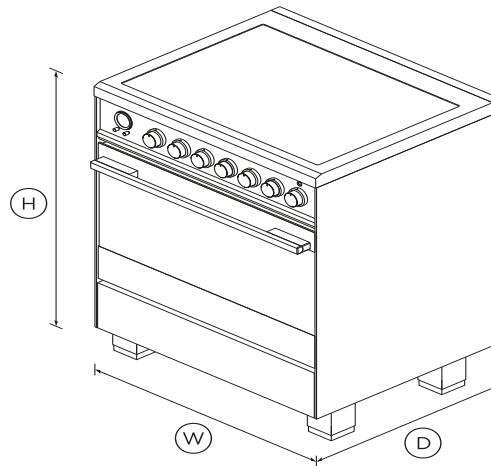

FEATURES & BENEFITS

Cooking Flexibility

Accurate, electronically-controlled oven heat, ensures a great result every time with 9 functions and pre-set temperatures including bake, grill, pastry bake with pizza mode and fan forced, for a variety of cooking styles.

A Modern Legacy

A refined, minimalist style with attention to the smallest details. High-performance cooking technology offers multiple cooking functions.

Quality and durability

Every detail has been carefully crafted. The solid, perfectly balanced soft-close door, machined stainless dials and glowing halo dials all add up to an exceptional, premium range.

Large capacity oven

The generous 3.5 cu.ft total capacity oven gives you plenty of space to cook multiple dishes at once, with enough room to fit a 26 lb turkey.

Easy to clean

Cleaning up spills is effortless. The flat ceramic cooktop is easily wiped after use, and the self-cleaning oven breaks down food residue at a very high temperature leaving a light ash that's easily removed with a damp cloth.

Even Heat

Accurate, electronically-controlled oven heat ensures a great result every time. Dishes on the top shelf turn out as perfectly as the ones on the bottom due to our AeroTech™ convection system that circulates air evenly throughout the entire oven.

SPECIFICATIONS

Accessories

2-pc grill system (Broil pan and	•
Broil pan	•
Full extension telescopic	2 sets (part 578776)

Accessories (sold separately)

Hob rear trim	3 1/8" (part 81656)
Kick strip, stainless steel	KICKOR30X1

Capacity

Shelf positions	7
Total capacity	3.5cu ft

Usable capacity **2.9cu ft**

Cleaning

- Acid resistant graphite enamel
- Drop down broil element
- Drop down grill element
- Flat easy clean glass surface
- Pyrolytic proof shelf runners
- Pyrolytic self-clean
- Removable oven door
- Removable shelf runners

Consumption

Energy usage **587kWh/year**
 In-use energy carbon **72.4kgCO2e/year**

Controls

- Audio feedback
- Automatic cooking/minute
- Automatic pre-set
- Celsius/Fahrenheit
- Electronic clock
- High resolution display
- Laser etched graphics
- Precise electronic temperature
- Sabbath mode
- Toughened fused glass
- Turned stainless steel clock
- Turned stainless steel dials

Oven features

- AeroTech™ technology
- Automatic rapid pre-heat
- Concealed element
- Electronic oven control
- Full extension telescopic
- Internal light **2 x 25W halogen (rear)**
- Soft open/close door
- True convection
- Turned stainless steel clock

Oven functions

- Aero Bake
- Aero™ Pastry with Pizza mode
- Number of functions **9**
- Rapid proof
- Roast
- True convection

Oven performance

Broil power **4050W**
 CoolTouch door **Triple glazed**
 Warming drawer power **220W**

Power requirements

Amperage **50A**
 Supply frequency **60Hz**

Product dimensions

Depth **25 1/4"**

Height **35 3/4 - 37 5/8"**
 Width **29 7/8"**

Rangetop features

Hob rear trim **3 1/8" (part 81656)**

Rangetop Performance

Number of cooking zones **4**

Safety

- ADA compliant
- Advanced cooling system
- Anti-tilt bracket
- Balanced oven door
- Catalytic venting system
- CoolTouch door
- Full extension telescopic
- Hi-light high speed ribbon
- Individual hot surface
- Non-tip shelves
- Spill containment **1/8 gallon**

SKU **81721**







The product dimensions and specifications in this page apply to the specific product and model. Under our policy of continuous improvement, these dimensions and specifications may change at any time. You should therefore check with Fisher & Paykel's Customer Care Centre to ensure this page correctly describes the model currently available. Fisher & Paykel Appliances Ltd 2020

Where applicable:

All appliances use energy, and energy usage typically generates carbon emissions. **Fisher & Paykel Appliances' In-use Energy Carbon Emissions Estimate** indicates carbon emissions from a product's in-use energy. This is calculated either annually or per cycle, using the product's market-specific energy label energy consumption data multiplied by the carbon emissions factor for energy in your country or region.

Our In-use Energy Carbon Emissions Estimate is designed to assist customers in making informed purchasing decisions when comparing different Fisher & Paykel products. For example, a heat pump dryer typically has a lower In-use Energy Carbon Emissions Estimate than a vented dryer.

Other product downloads available at fisherpaykel.com

-  [User Guide Freestanding Range EN](#)
-  [Guide d'utilisation FR](#)
-  [Service & Warranty](#)
-  [Energy Label Electric Range FR](#)
-  [Guide d'installation FR](#)
-  [Installation Guide Freestanding Cooker EN](#)
-  [Data Sheet Electric Range](#)



A PEACE OF MIND SALE

24 Hours 7 Days a Week Customer Support

T 1.888.936.7872 **W**www.fisherpaykel.com