

RS36A72J1

36" ACTIVESMART™ BUILT-IN PANEL READY FRENCH DOOR REFRIGERATOR WITH ICE



The next generation of family size Fisher & Paykel Built-in refrigerators offers a new level of fit and finish to deliver seamless kitchen integration. Designed for easy installation and flush fit into new or existing kitchen cabinetry with minimal $\frac{1}{8}$ " gaps. With internal ice making and SmartTouch controls these refrigerators are designed to match with our family of kitchen appliances.



A PEACE OF MIND SALE

24 Hours 7 Days a Week Customer Support

T 1.888.936.7872 W fisherpaykel.com

FEATURES

Seamless Integration

The Built-in series minimizes gaps through heavy-duty inline hinges and adjustable doors enabling minimal gaps to create consistent lines throughout your kitchen. The series fits flush with cabinetry to reduce disruption and deliver design freedom.

Sized to Suit

The spacious 36" French Door refrigerator is designed for family life, with double doors for easy access to uninterrupted refrigerator space.

Fresher Food for Longer

ActiveSmart™ technology helps keep your food fresher for longer by constantly monitoring how you use your refrigerator and adapting to maintain a controlled environment and optimum temperature.

Easy Cleaning

Removable, spill-safe cantilevered glass shelves are designed to contain drips and spills that can be simply wiped away, while leaving the interior walls completely smooth and easy to clean. Storage bins just need a wipe to keep spotless.

Flexible Living

These refrigerators adapt to suit your lifestyle by streamlining food preparation and organization with SmartTouch controls, flexible shelving and storage options, and slide out bins and trays. The water filter is easily accessible for quick cleaning or replacement. LED lighting in all compartments lights up all the shelves, bins and trays.

Efficient

These ActiveSmart™ refrigerators intelligently adapt to daily use to help save energy, cooling and defrosting only when they need to without compromising on food care.

BENEFITS

SPECIFICATIONS

Finish

Panel Ready (apply your own cabinetry façade)

Dimensions (excluding door panels)

H71 $\frac{2}{32}$ " x W35 $\frac{1}{32}$ " x D23 $\frac{3}{4}$ "

Cabinetry height with included trim kit

72"

Capacity

Refrigerator	11.7 cu.ft
Freezer	5.1 cu.ft
Total	16.8 cu.ft

ENERGY STAR Certified

●

Performance

ActiveSmart™ technology	●
Frost free freezer	●
Adaptive defrost	●
Humidity control system	●
Sabbath mode	●
Internal ice making	●

Accessories

Water filter part number	842802
--------------------------	--------

Warranty

Parts & labor	2 years
Additional sealed system parts	3 years

SKU	24337
UPC Code	822843243372

For full specifications visit fisherpaykel.com

Fisher & Paykel

CAVITY PREPARATION

36" ACTIVSMART™ BUILT-IN REFRIGERATOR

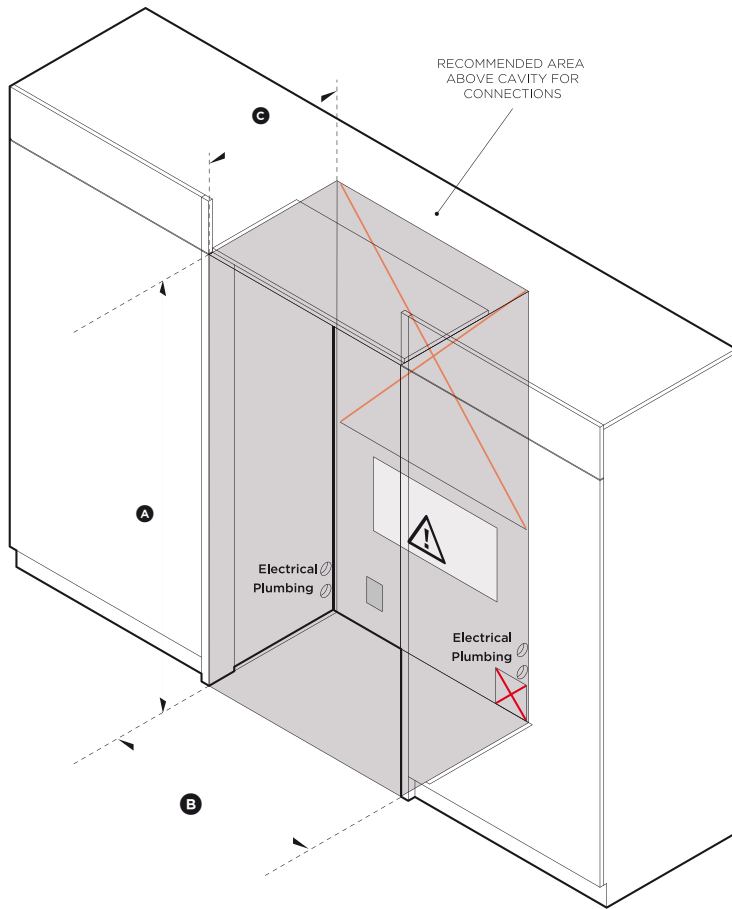

ISO VIEW OF CAVITY

Framed: Finished return, sides and top

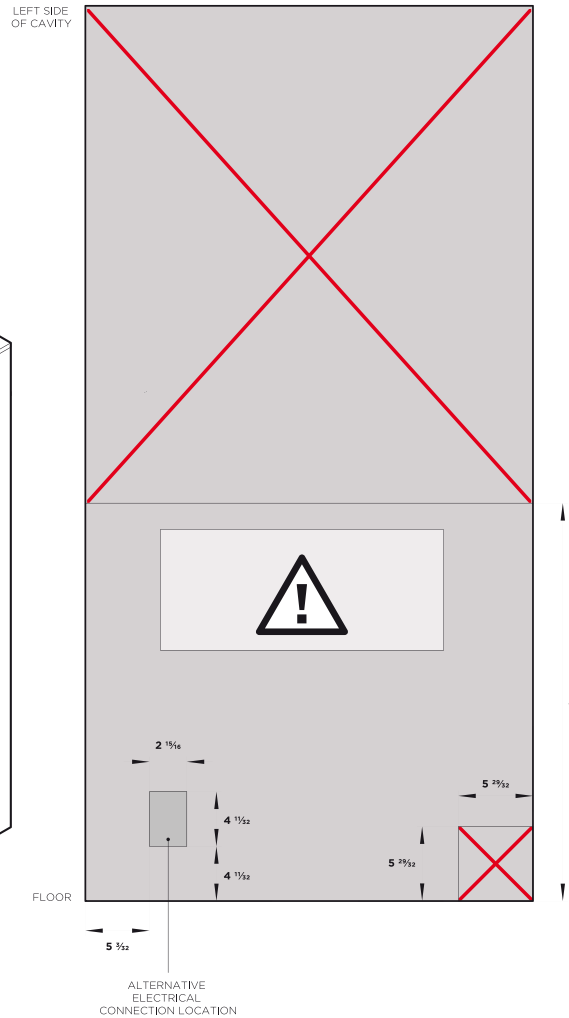
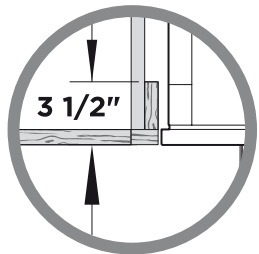

REAR OF CAVITY

Model no:

RS36A72J1

Cavity Dimensions		in
Ⓐ Overall height of cavity		72"
Ⓑ Overall width of cavity	when adjoining cabinetry cannot share 5/32" door gap	36"
Ⓒ Overall depth of cavity		25"

Specifications

Electrical

Supply	115 VAC, 60 Hz
Service	10 amp circuit

Plumbing

Supply	1/4" (6mm) PEX hose or copper tubing (to suit local regulations)*
Pressure	min 22 psi (150 kPa) max 120 psi (827 kPa) @ 68°F (20°C)

NOTE: Recommended that the electrical & water connection be located above the fridge cavity. Optional to locate in an adjacent cabinet to either side of the fridge.

✗ Do not locate water or electricity in this area, keep clear of connections.

⚠ CAUTION: Central area can only fit electrical plug if it is placed within a recessed cavity.

* Customer to supply.

IMPORTANT NOTE: The product dimensions and specifications apply at the date of issue. Under our policy of continuous product improvement, these dimensions and specifications may change at any time. Dimensions may vary by $\pm 3/32"$. Please read the installation manual for detailed information on installing the product or visit fisherpaykel.com.

Fisher & Paykel

DATA SHEET

36" ACTIVESMART™ BUILT-IN REFRIGERATOR

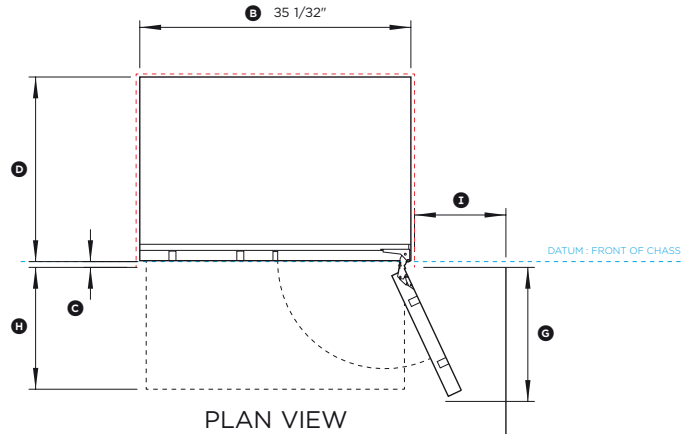
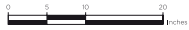

PLAN VIEW

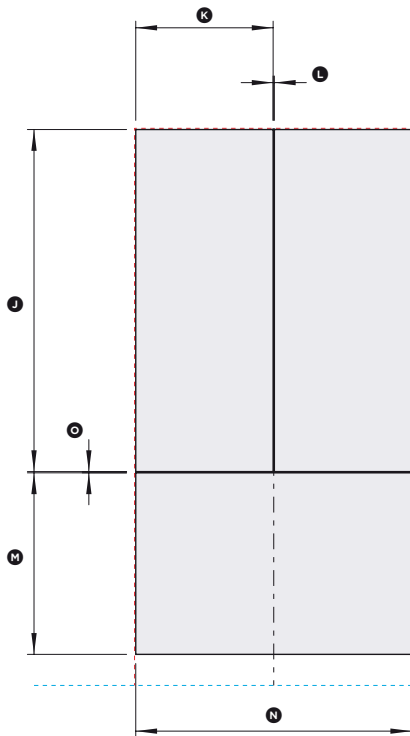

CUSTOM PANELS

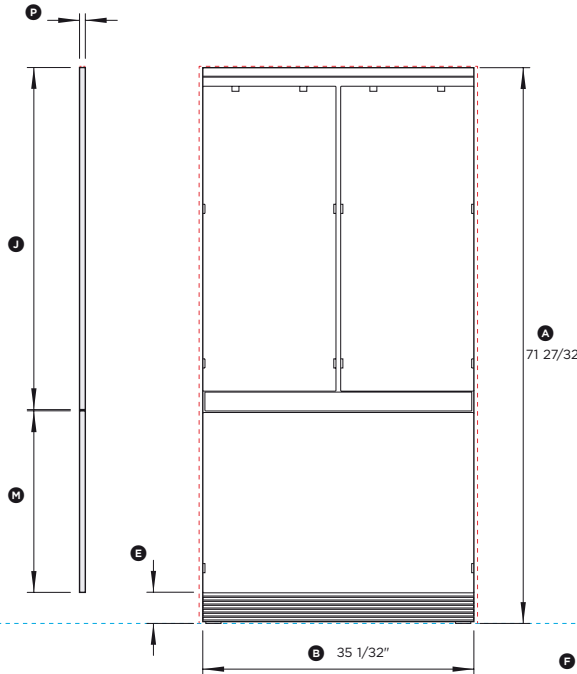

FRONT VIEW

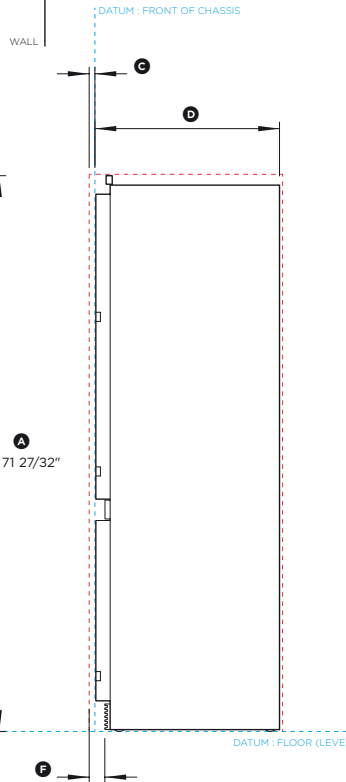

PROFILE VIEW

Model no:

RS36A72J1

Product Dimensions	in
Ⓐ Overall height of fridge	71 27/32"
Ⓑ Overall width of fridge	35 1/32"
Ⓒ Depth of fridge front panels (excl. handles)*	3/4"
Ⓓ Overall depth of fridge (excl. front door panels)	23 3/4"
Ⓔ Height from bottom datum to top of toekick	4"
Ⓕ Depth of toekick measured from front of door panels*	2"
Ⓖ Depth of door (widest opening) measured from front of cabinetry	17 5/16"
Ⓗ Depth of drawer (open) measured from front of cabinetry*	15 3/4"
Ⓘ Minimum door clearance** to adjacent wall (115° - full internal access)*	11 13/16"

* Door panels to be manufactured and fitted by cabinetmaker, thickness min 5/8" - max 3/4".

** Measured from front cabinetry edge.

Custom Panel Dimensions	in
Ⓙ Height of top door panel	44 7/32"
Ⓚ Width of top door panel	17 3/4"
Ⓛ Gap between top door panels	5/32"
Ⓜ Height of bottom drawer panel	23 15/32"
Ⓝ Width of bottom drawer panel	35 21/32"
Ⓞ Gap between top door panels and bottom drawer panel	5/32"
Ⓟ Depth of custom panels	min 5/8" max 3/4"
Maximum weight of an individual top door panel	22 pounds
Maximum weight of bottom drawer panel	21 pounds

Minimum Clearances	in
Minimum cabinetry gap clearance from edge of custom panels	5/32"
Overall height of cavity	72"
Overall width of cavity	
when adjoining cabinetry cannot share 4mm door gap	36"
Overall depth of cavity	25"

INDICATES PRODUCT DATUM -----
INDICATES MINIMUM CABINETRY CLEARANCES - - - - -

IMPORTANT NOTE: The product dimensions and specifications apply at the date of issue. Under our policy of continuous product improvement, these dimensions and specifications may change at any time. Dimensions may vary by ±3/32". Please read the installation manual for detailed information on installing the product or visit fisherpaykel.com.