

Oven, 24", 16 Function, Self-cleaning

Series 9 | Minimal

Black Glass



A highlight of the Fisher & Paykel collection, this Minimal style oven with touchscreen guided cooking helps to ensure every dish is cooked to perfection.

- Touchscreen guided cooking capability offers helpful tips for different food types as well as full recipes
- 3 cu ft total capacity, with 16 oven functions including Pastry Bake, Roast, Air Fry and Dehydrate
- Pyrolytic self-cleaning function breaks down food residue for an easy clean

DIMENSIONS

Height	23 9/16"
Width	23 7/16"
Depth	22 1/4"

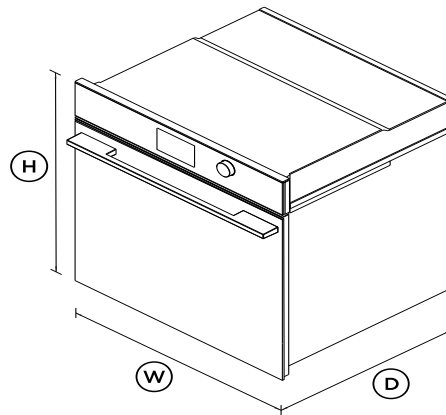

FEATURES & BENEFITS

Cook with confidence

Using the large 5" touchscreen interface, you can cook with a favorite method, hero ingredient, cooking function or recipe. Your oven will guide you through the steps, or change the temperature and heat type automatically, depending on your selection.

Generous capacity

With an exceptional 3 cu ft total capacity, you can create several perfectly cooked dishes at once using multiple shelves. Non-tip,

full-extension shelves help to ensure safe removal of hot dishes.

Exceptional performance

Our unique cooking technologies were developed to help deliver perfect results. ActiveVent ensures optimized moisture levels, while AeroTech™ circulates heat evenly for a consistent temperature.

Safe and sound

The CoolTouch door of this built-in oven is safe to touch from the outside. Sturdy, fully extendable shelves slide all the way out, reducing the need for you to reach inside.

SELF-CLEANING

Pyrolytic self-clean breaks down food residue at a very high temperature, leaving a light ash that's easily removed with a damp cloth. The enamel coated side racks don't need to be removed when using this function.

Complementary design

Designed to blend seamlessly into the kitchen, this Minimal style oven features subtle textural and tonal contrasts. Available in a sleek black finish to support a considered kitchen design. Pair with a Warming Drawer for the ultimate kitchen solution.

Multi-function flexibility

Each function has been tailored, tested and perfected to ensure that no matter what you're cooking, you've got the right heat to match. Purchase our Wireless Temperature Sensor accessory and precisely monitor cooking in real time (accessory sold separately).

SPECIFICATIONS

Accessories

Broil grid	1
Broil pan	1
Broil rack	1
Pyrolytic proof shelf runners	•

Step down wire shelf **1**

Capacity

Shelf positions **6**
 Total capacity **3cu ft**
 Usable capacity **2.5cu ft**

Cleaning

- Acid resistant graphite enamel •
- Pyrolytic proof shelf runners •
- Pyrolytic self-clean •
- Removable oven door •
- Removable oven door inner •
- Removable shelf runners •

Consumption

Energy usage **281kWh/year**
 In-use energy carbon **34.6kgCO2e/year**

Controls

- Adjustable audio and display •
- Audio feedback •
- Automatic cooking/minute •
- Automatic pre-set •
- Celsius/Fahrenheit •
- Delay start •
- Electronic clock •
- Electronic oven control •
- Food probe •
- Guided cooking by food type •

- Halogen lights •
- Intuitive touchscreen display •
- Multi-language display **UK English, US English,**
- Sabbath mode with Star K •
- Soft close doors •
- Turned stainless steel dials •
- Wi-Fi connectivity •
- Wireless temperature sensor •

Functions

- Aero Bake •
- Aero Broil •
- Air fry •
- Bake •
- Broil •
- Classic bake •
- Dehydrate •
- Number of functions **16**
- Pastry Bake •
- Pizza bake •
- Rapid proof •
- Roast •
- Self-clean •
- Slow cook •
- True Aero •
- Vent bake •
- Warm •

Performance

- ActiveVent™ system •
- AeroTech™ technology •
- Automatic rapid pre-heat •
- Temperature range **95 °F - 540 °F**

Power requirements

Amperage **16.6 - 19.4A**
 Supply frequency **60Hz**
 Supply voltage **208C - 240VV**

Product dimensions

Depth **22 1/4"**
 Height **23 9/16"**
 Width **23 7/16"**

Safety

- ADA compliant •
- Balanced oven door •
- Catalytic venting system •
- Control panel key lock •
- CoolTouch door •
- Non-tip shelves •
- Safety thermostat •









Warranty

Parts and labour **2 years**

SKU **82517**

The product dimensions and specifications in this page apply to the specific product and model. Under our policy of continuous improvement, these dimensions and specifications may change at any time. You should therefore check with Fisher & Paykel's Customer Care Centre to ensure this page correctly describes the model currently available. ? Fisher & Paykel Appliances Ltd 2020

Other product downloads available at fisherpaykel.com

-  [Service & Warranty](#)
-  [Energy Label Oven](#)
-  [User Guide Oven EN](#)
-  [Installation Guide Wall Oven EN](#)
-  [Guía de instalación SP](#)
-  [Guide d'installation FR](#)
-  [Preliminary Specification Guide Wall Oven](#)
-  [Datasheet Oven](#)



A PEACE OF MIND SALE

24 Hours 7 Days a Week Customer Support

T 1.888.936.7872 W www.fisherpaykel.com