

Dual Fuel Range, 36", 6 Burners, Self-cleaning, LPG

Series 9 | Professional

Stainless Steel | LPG



Get the best of gas and convection technology in this striking range with intuitive touchscreen and specialized cooking functions.

- Guided cooking using your touchscreen makes it simple to cook by food, function or recipe.
- Top burner heat of 19,000 BTU, for seriously fast boiling
- 4.8 cu ft total oven capacity
- Beautiful LED halo-illuminated dials provide information at a glance

DIMENSIONS

Height	35 3/4 - 36 3/4"
Width	35 7/8"
Depth	29 1/8"

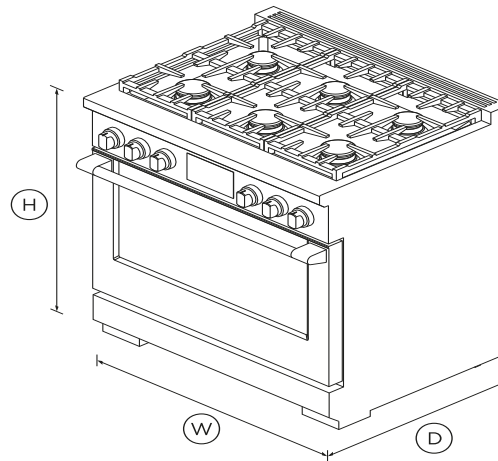

FEATURES & BENEFITS

COOK WITH CONFIDENCE

Our touchscreen interface provides an intuitive guided cooking experience that helps deliver perfect results, whether you've been cooking all your life or just starting out. Cook with a favorite method, a hero ingredient, or a go-to cooking function or recipe. The screen tilts for improved ergonomics and optimal visibility while cooking.

GENEROUS CAPACITY

Featuring a large 4.8 cu ft total capacity convection oven, with

enough room to fit a 32 lb turkey and full-size baking sheets.

COOKING FLEXIBILITY

No matter what you're cooking, you've got the right heat to get perfect results. Each of the 15 oven functions have been extensively researched and carefully designed to cater to a broad range of dishes and cooking styles. The handy food probe helps you monitor your progress.

COOKTOP POWER

Sealed dual flow burners deliver cooktop power up to 19,000 BTU for seriously fast boiling, and precise 140°F full surface, low temperature cooking with the gentlest of flames.

DESIGN QUALITY

This range has craftsmanship in every detail, with real stainless steel, cast-iron grates, and beautifully weighted, halo illuminated dials. Each cavity features incandescent lights and full extension telescopic racks. From the robust legs to the powerful cooktop, this Range is built to last.

EASY TO CLEAN

The oven features a self-cleaning function and self-clean proof side racks, which don't need to be removed when using this function.

SPECIFICATIONS

Accessories

Adjustable feet covers	•
Branded coin end cap	•
Square handle option	AH-R36

Burner ratings

Maximum burner power	19000 BTU
Power back centre	13000BTU
Power back left	13000BTU

Power back right	13000BTU
Power front centre	15000BTU
Power front left	19000BTU
Power front right	19000BTU
Total cooktop power	92000 BTU

Capacity

Shelf positions	5
-----------------	----------

Cleaning

Easy clean porcelain basepan	•
Pyrolytic self-clean	•

Controls

Dial with illuminated halo	•
Electric circuit	4 wire
High resolution display	•
Metal illuminated dials	•
Multi-language interface	•
Precise cooking with food	•
Recipe and food based	•
Sabbath mode	•
Tilting touch screen interface	•
Wi-Fi connectivity	•

Gas Requirements

Fitting and pipe	½ NPT, min. 5/8" flex line
Supply Pressure (LPG)	11" to 14" W.C

Oven features

Concealed element	•
Electronic oven control	•
Food probe	•
Full extension telescopic	•
Internal light	•
Large broil pan	•
Self-clean proof side racks	•
True convection	•

Oven functions

Air fry	•
Bake	•
Classic bake	•
Clean	•
Convection Broil	•
Convection bake	•
Dehydrate	•
Maxi Broil	•
Number of functions	15
Pastry bake	•
Pizza bake	•
Rapid proof	•
Roast	•
Slow cook	•
True convection	•
Warm	•

Oven performance

Main oven - True convection	2500W
-----------------------------	--------------

Power requirements

Rated current	30A
Supply frequency	60Hz

Product dimensions

Depth	29 1/8"
Depth (excluding handles)	29 1/8"
Height	35 3/4 - 36 3/4"
Width	35 7/8"

Rangetop features

Sealed Dual Flow Burners™	6
Vent trim included	•

Recommended Back Guards Ventilation

Combustible situation	BGRV3-3036H
Non combustible situation	BGRV2-3036 / BGRV2-1236
Recommended hood	HCB36-6_N (36" Professional)

Safety

ADA compliant	•
Full extension telescopic	•









Warranty

Parts and labor	Limited 2 years
-----------------	------------------------

SKU	81899
-----	--------------

The product dimensions and specifications in this page apply to the specific product and model. Under our policy of continuous improvement, these dimensions and specifications may change at any time. You should therefore check with Fisher & Paykel's Customer Care Centre to ensure this page correctly describes the model currently available. © Fisher & Paykel Appliances Ltd 2020

Other product downloads available at fisherpaykel.com

-  [User Guide Dual Fuel Cooker](#)
-  [Service & Warranty](#)
-  [Installation Guide](#)
-  [Specification Guide Dual Fuel Range](#)
-  [Data Sheet Dual Fuel Range with Backguard BGRV2-1236](#)
-  [Data Sheet Dual Fuel Range with Backguard BGRV2-3036](#)
-  [Data Sheet Dual Fuel Range with Backguard BGRV2-3036H and Angled Trim](#)
-  [Data Sheet Dual Fuel Range](#)
-  [Planning Guide Dual Fuel Range](#)



A PEACE OF MIND SALE

24 Hours 7 Days a Week Customer Support

T 1.888.936.7872 **W**www.fisherpaykel.com