

FISHER & PAYKEL

**FRONT LOADER
WASHING MACHINE**

WH8060J5 & WH9060J5 models

USER GUIDE

NZ AU

Registration

To register your product visit our website: fisherpaykel.com/register

CONTENTS

Safety and warnings	4
Get to know your washer	7
Control panel	8
First use	9
Add detergent or softener	10
Sort your items	11
Understand fibre types	12
Load the washer	13
Select a fibre type	14
Select an item type	15
Select a treatment	16
Select a colour	17
Select a soil level	18
Select a dispensing option	19
Set the cycle	20
Customise cycle settings	21
Save favourite cycles	22
Set delay start	23
Wash options	24
Change cold wash default	25
Adjust Auto Dose amount	26
Wash temperatures and spin treatments	27
Choose a detergent	28
Wi-Fi connection and Remote Mode	29
Clean and maintain your appliance	31
Clean the dispenser drawer	32
Run the Drum Clean cycle	33
Unlock the door	34
Clean the pump filter	35
Troubleshooting	37
Faults and alerts	40
Compliance information	41
Manufacturer's Warranty and Service Guide	42

⚠ WARNING!



Electric Shock Hazard

Failure to follow this advice may result in electric shock or death.

- If you are using an extension cord or a portable electrical outlet device (e.g. multi-socket outlet box), ensure that it is positioned so that it does not come into contact with water or moisture.

READ AND SAVE THIS GUIDE

WARNING!

Read Safety Guide. Failure to follow all guides and rules could cause personal injury or property damage. Use this appliance only for the intended purpose as described in the user guide and installation guide of this appliance. When using this appliance, always exercise basic safety precautions including the following:

General

- This product has been designed for personal, family or household use. This product is not designed for any commercial use.
- Do not touch or operate the appliance with wet hands or with bare feet.
- A damaged power cord must be replaced by a Fisher & Paykel trained and supported service technician or similarly qualified person in order to avoid a hazard. Do not use the machine until it has been repaired to avoid a risk of electric shock.
- Do not operate this appliance if it has been damaged during transport. Contact your Fisher & Paykel dealer or Fisher & Paykel trained and supported service technician.
- This appliance is not intended for use by persons (including children) with reduced physical, sensory or mental capabilities, or lack of experience and knowledge, unless they are supervised or given instructions on how to use the appliance by someone responsible for their safety.
- Keep children away from the washing machine while it is in operation.
- Supervise children to ensure they do not play with the appliance or climb inside the drum.
- Do not swing on or put weight on the door.
- Check and remove all objects from pockets, e.g. lighters and matches.
- The washing machine should only be used for washing and rinsing of textiles where this is indicated on the care label.
- Do not add petrol, dry-cleaning solvents, or other flammable or explosive substances to the wash water. These substances give off vapours that could ignite or explode.
- Do not wash articles that have been previously cleaned in, washed in, soaked in, or spotted with gasoline, dry-cleaning solvents, or other flammable or explosive substances as they give off vapours that could ignite or explode.
- The door will be locked from the start of the cycle until the cycle is complete for safety reasons. It is possible to open the door during the cycle under certain conditions. Never force the door open.
- Do not touch the door during a cycle as the door can become hot.

SAFETY AND WARNINGS

- Keep children away from the washing machine.
- Do not open the detergent dispenser during the cycle as hot water may come out of it.
- Read and follow the detergent manufacturer's instructions carefully. Instructions on how to use the detergent will be clearly indicated on the pack. Remember to store your detergents out of the reach of children.
- Do not wash an electric blanket in your washing machine unless the care label specifically states it is safe to do so.
- Do not wash curtains in this washing machine, as sunlight makes them brittle and they may disintegrate during washing.
- Do not put dripping wet clothes on top of the washer as this could create an electrical hazard.
- The only user-removable parts of the washing machine are the inlet hose(s), dispenser drawer and pump filters. No other parts are designed to be removed by anyone other than a Fisher & Paykel trained and supported service technician.
- Do not overload your washing machine beyond its rated capacity.

MODEL CODE	MAXIMUM CAPACITY* (KG)
WH8060J5; WH9060J5	8kg; 9kg

*Capacity refers to the maximum dry weight of items the washing machine can wash at any one time

Installation

- Install the appliance on a solid and level floor surface. Ensure it has at least 12mm clearance on each side and at the top, and at least 30mm clearance at the rear.
- The appliance must not be installed on any textured floor coverings (e.g. carpet, rugs).
- This appliance can be installed on a compatible Fisher & Paykel plinth. To ensure stability, the plinth must be fitted correctly with the appliance. For installation instructions and compatible plinth models, refer to your installation guide.
- Do not install or operate this appliance on any other plinth or structure.
- Ensure the installation provides accessibility to the plug or incorporate a switch in the fixed wiring in accordance with the wiring rules to allow disconnection of the appliance from the supply after installation.
- Do not attempt to lift appliance on your own as this could cause harm or injury. Always lift appliance with at least two people.
- Ensure any transit bolts have been removed before operating appliance.

Water supply requirements:

- Inlet water pressure: Max. 1MPa (145psi), Min. 50kPa (7.3psi)
- Inlet water flow rate: Min. 6 litres/minute
- A pressure-reducing valve must be installed if pressure is higher than 1MPa.
- For optimum wash performance check the supply pressure is within the recommended range.
- New hose sets provided should be used to connect the appliance to the water mains. Old hose sets should not be re-used.
- We recommend the inlet hose(s) are changed every 5 years. WARNING: Failure to do so may result in a flood and damage to property.
- The hot water temperature should not exceed 65°C and the cold water temperature should not exceed 35°C. Temperatures above these may cause the appliance to fault or cause damage to it.

SAFETY AND WARNINGS

Disposal

- When disposing of this appliance, the door should be removed to avoid children getting trapped inside, and that the electrical cable is cut off close to the cabinet.

For more detailed information and comprehensive user and installation instructions, download the user and installation guides via www.fisherpaykel.com

GET TO KNOW YOUR WASHER



Get the app for a smarter experience

- Access extra features and information
- Track and run cycles from your phone
- Customise your favourite cycles
- Get the latest software updates
- Register your product for streamlined support



FEATURES AND ACCESSORIES

- | | |
|---------------------------------------|----------------------------|
| ① Detergent/Softener dispenser drawer | ③ Drum light (inside drum) |
| ② Control panel | ④ Pump filter |

CONTROL PANEL



① Power	Press and hold to turn the washer ON/OFF .
② Key lock	Press and hold to lock controls to prevent accidental use.
③ Remote	Press to connect appliance to your mobile device and operate it via the app.
④ Fibre Types	Press to select a fibre type.
⑤ Quick 30	Press to run a 30-minute wash cycle for mixed items.
⑥ Favourite	Press to run a saved Favourite cycle. Set as QUICK 15 cycle by default. See 'Save Favourite cycles' for how to set a new Favourite.
⑦ Item Type selector	Press to select an item type.
⑧ Treatment selector	Press to select a treatment.
⑨ Colour selector	Press to select a colour.
⑩ Soil Level selector	Press to select a soil level.
⑪ Auto Dose selector	Press to select an Auto Dose option.
⑫ Time display	Displays cycle duration and messages.
⑬ Delay adjust	Press to increase or decrease time delay.
⑭ Wi-Fi	Indicates when appliance is connected to Wi-Fi.
⑮ Cold Wash	Press to turn Cold Wash ON/OFF .
⑯ Crease Free	Press to turn Crease Free ON/OFF .
⑰ Drum Clean	Press to select Drum Clean cycle.
⑱ Add Item	Press to pause the cycle and add an item.
⑲ Confirm	Press to confirm settings.
⑳ Start/Pause	Press to start or pause a cycle.

FIRST USE

Before you wash your first load, we recommend running a **QUICK 15** cycle. This will prime the Auto Dose detergent dispenser and enable you to check that the hoses are connected properly and the washer is sitting level.



1. Add liquid detergent to Tank 1.

Skip this step if you are not using the Liquid Detergent Auto Dose tank. The manual dispenser does not need to be primed.

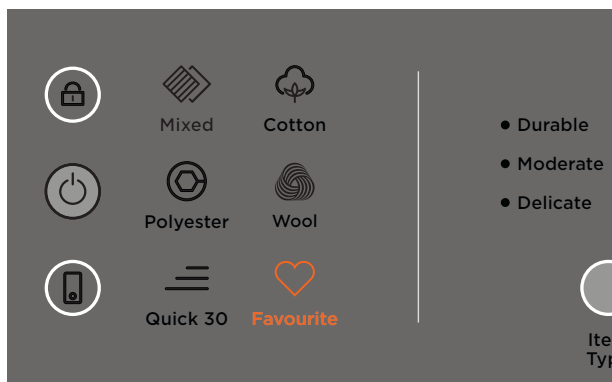

2. Press **FAVOURITE**  to start a **QUICK 15** cycle.

FAVOURITE  is set to **QUICK 15** by default. See 'Save Favourite cycle' for information about how to change this.

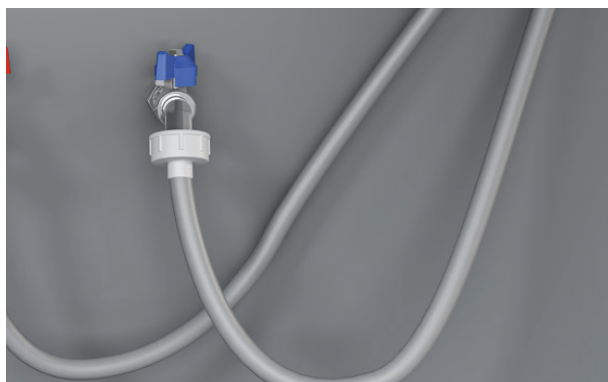

What to look for

- If the washer is leaking, check the hose connections.
- If the washer is moving around, adjust the feet to level it.

See the 'Installation guide' for instructions.

ADD DETERGENT OR SOFTENER

Your washer has three dispenser tanks for automatic and manual dispensing, giving you the flexibility to use a combination of detergents and softener. See 'Select a dispensing option' for how to switch between Auto Dose and Manual dispensing.



Auto Dose tanks

Auto Dose tanks automatically dispense liquid detergent or fabric softener during a cycle. The dosage will adjust depending on the fibre, item type and treatment selected, as well as the load size and soil level. See 'Adjust Auto Dose amount' to change default dosage amounts.

Tank 1 For everyday liquid detergent **Tank 2** For softener

Each Auto Dose tank lasts for multiple cycles. When the tanks need to be refilled, the Auto Dose indicators will flash and **Ld** will show on the display.

Manual dose tank

The Manual dose tank dispenses liquid or powder detergent. The dosage is determined by the amount of detergent you add to the tank, so only add as much detergent to the Manual tank as you need for that load.

SORT YOUR ITEMS

Sorting your items well is essential for taking care of your clothes and getting the best results from your appliance. Follow these steps every time you use the washer.



1. Check each care label to see the fibre composition and how each garment should be washed. See 'Understand fibre types.'



2. Sort items into loads of similar fibre, item type and item colour.



3. Check pockets, close fasteners and zippers, and untangle items before loading. Use a small washbag for delicate items, and be careful not to overfill it.

UNDERSTAND FIBRE TYPES

Every cycle starts with fibre type

Each fibre type responds differently to washing and drying. This appliance uses a fibre-led system and precision sensing to wash your items, so selecting the right fibre type for each load is key to setting the best cycle each time.

Treat for the most delicate fibre

Items may be a blend of multiple fibres — some more delicate than others. The care label on an item will tell you what fibre or fibres the item is made of and how to care for it.

Select the fibre type on your washer that applies to the most sensitive or delicate fibre in the blend, even if it is only a small percentage.

Identify delicate fibres

This table helps identify the most delicate or sensitive fibres commonly found on care labels. It also offers alternative cycle suggestions for most specialist fibres.

Recommendations may not suit all items — always check your care label first.

For best results, use a detergent designed for the most delicate fibre. See ‘Choose a detergent’ for more information.

SENSITIVITY	COMMON FIBRES	FIBRE TYPE	ITEM TYPE	
<div style="display: flex; align-items: center;"> <div style="text-align: right; margin-right: 5px;">High</div> <div style="flex-grow: 1; border-left: 1px solid black; border-right: 1px solid black; position: relative;"> <div style="position: absolute; top: -10px; left: 50%; transform: translate(-50%, -100%);">↑</div> <div style="position: absolute; bottom: -10px; left: 50%; transform: translate(-50%, 100%);">↓</div> </div> </div>	Cashmere	Not suited for machine washing in this model.		
	Down			
	Silk			
	Wool, Merino	Wool		
	Elastane, Lycra	Polyester		
	Viscose, Bamboo, Rayon, Modal	Cotton		
	Lyocell, Tencel™			
	Acrylic	Polyester	Delicate	
	Linen	Cotton		
	Ramie			
	Nylon, Polyamide	Polyester		
	Polyester	Polyester, Mixed		
	Low	Cotton	Cotton, Mixed	

LOAD THE WASHER

Your washer performs best when it has the right sized load for the item types. After sorting your load, place items carefully in the washer to ensure the load is balanced.

Always wash small, delicate items in a wash bag, and wash large items on their own.

Maximum load size

The maximum load size changes based on the type of items in a load. Follow the guide below to avoid overfilling the appliance and maintain good wash performance.



ITEM TYPES	MAX LOAD SIZE
Mixed, Cotton, Polyester	
Delicate	Small
Moderate, Durable	Large
Sheets, Towels	Large
Wool	
Delicate (Woolmark)	Small
Other Treatments	
Favourite - Quick 15	Small
Quick 30	Medium
Refresh	1 or 2 Items
Sanitise	As per fibre/item type

SELECT A FIBRE TYPE

Select the specific fibre type that matches the load or choose the fibre type that applies to the most delicate fibre. The wash cycle will adjust to suit. See 'Understanding fibre types' if you are not sure which fibre type to select for your load.

Mixed

For everyday loads with a mixture of fibres and for cotton-polyester blends.

Cotton

For 100% cotton items, cotton blends and compatible fibre types.

Polyester

For 100% polyester items and compatible fibre types.

Wool

For 100% woollen items and wool blends. This cycle meets the Woolmark requirements for drying and washing items labelled 'Machine wash'.

Most woollen handcrafted garments are not made of machine washable wool and we recommend that you wash them by hand only. Hand-washed woollens may still be spun in your washer, but ensure they have been well wrung out before placing them in the washer.

Washing underlays and sheepskins is not recommended because they could produce excessive amounts of lint that may cause pump blockages.

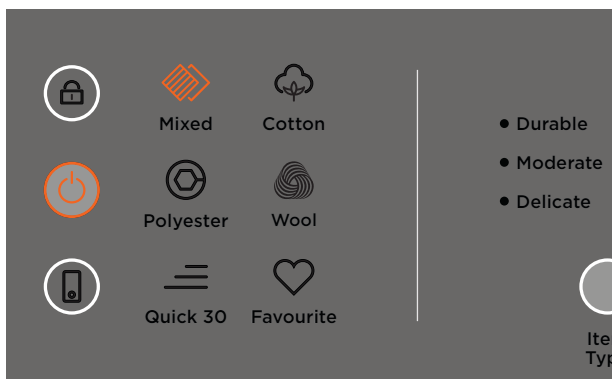

1. Press **POWER**  to turn the washer on, then select a fibre type.

SELECT AN ITEM TYPE

Item Type relates to the durability of items in your load. Wash garments and items of similar durability together.

Durable

Strong and resilient items like workwear and outerwear.

Moderate

Everyday items like t-shirts, shirts, shorts and pants.

Delicate

Light and easily damaged items like blouses, dresses and other items.

Sheets

Items such as bed sheets, pillow cases and duvet covers.

Towels

High absorbency towelling fabric items like bath, beach and hand towels.

- Wash
- Refresh
- Sanitise
- Rinse
- Spin
- Dark
- Mixed
- Light
- White
- Heavy
- Moderate
- Light

Durable Moderate Delicate Sheets Towels

Item Type Treatment Colour Soil Level

2. Select an item type.

SELECT A TREATMENT

Treatment lets you select from a range of specialised wash treatments to suit your needs.

Wash

A tailored wash, rinse and spin based on fibre and item type selection to remove soils. Detergent dose, water temperature, wash times, tumble patterns and spin speeds are optimised based on fibre type, item type and load size to ensure perfect results.

Refresh

Designed to refresh dry items using steam and tumbling to reduce creases and odours. For best results use this cycle for one or two items at a time. Ideal for items like dress shirts to refresh before ironing.

Sanitise

An extra hot treatment designed to eliminate bacteria. Ideal for sanitising items that can handle high temperatures, like tea towels, dishcloths, towels and sheets, but unsuitable for delicate items.

Rinse

A tailored rinse and spin based on fibre and item selection. Removes detergent and prepares items for drying.

Spin

A tailored spin based on fibre and item selection. Items are spun at an optimised speed to remove excess moisture. Ideal for preparing clothes for drying.

● Wash

● Refresh ● Dark

● Durable ● Sanitise ● Mixed ● Heavy

● Moderate ● Sheets ● Rinse ● Light ● Moderate

● Delicate ● Towels ● Spin ● White ● Light

Item Type Treatment Colour Soil Level

3. Select a treatment.

SELECT A COLOUR

Different colours require different care. Colour selection adjusts the wash temperature automatically to suit the items in the load.

Dark

Designed to care for dark-coloured items, with a cooler wash to help preserve vibrancy and prevent fading.

Mixed

Designed to care for loads with a mixture of colours. Ideal for everyday laundry loads, providing a balanced wash temperature to preserve vibrancy and help prevent colour transfer.

Light

Designed to care for light-coloured items, with an optimised wash temperature to help maintain brightness.

White

Designed to care for white items, with an optimised wash temperature to help maintain whiteness.

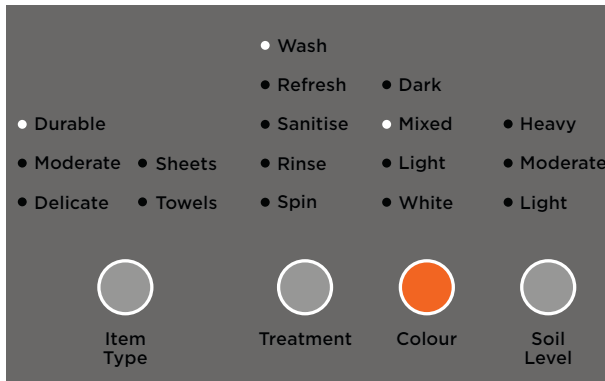

4. Select a colour.

SELECT A SOIL LEVEL

Soil Level adjusts the wash cycle based on how soiled or stained items are. Select a soil level to suit the load. The wash time and detergent dose will automatically adjust to suit your selection.

Heavy

For items with high levels of soiling, using higher detergent dosage and longer wash times.

Moderate

Ideal for everyday laundry loads, providing a balanced wash cycle with optimal detergent dosage and wash time.

Light

For items with low levels of soiling, reducing detergent dosage and wash time.

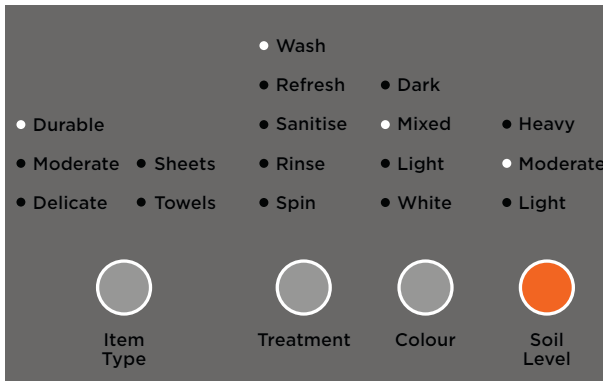

5. Select a soil level.

SELECT A DISPENSING OPTION

You can select between Auto Dose dispensing options and Manual dispensing on your washer. Choose the correct dispensing method to ensure detergent is dispensed into the washer.

Auto Dose

Dispenses a controlled dosage of detergent or detergent and softener from the selected Auto Dose tanks. Auto Dose tanks do not need to be refilled until they start to run low. Your washer will display an alert when the tanks have only 2 or 3 doses remaining.

Manual

Dispenses all detergent in the Manual tank. Add the correct dose of detergent to the Manual tank before each manual cycle.

Select Manual for detergent pods

If using a detergent pod, set **AUTO DOSE** to **MANUAL**, add the pod directly to the washer drum and put your items on top of it.

Detergent	Everyday liquid detergent in Tank 1.
Detergent and Softener	Everyday liquid detergent in Tank 1 and softener in Tank 2.
Manual	Your choice of liquid or powder detergent in the Manual tank, or a detergent pod added directly to the washer drum.
Manual and Softener	Your choice of detergent in the Manual tank and softener in Tank 2.

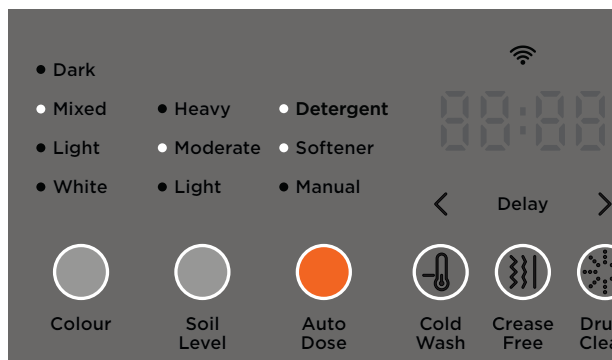

6. Press **AUTO DOSE** as required to toggle between the different dispensing options.

SET THE CYCLE

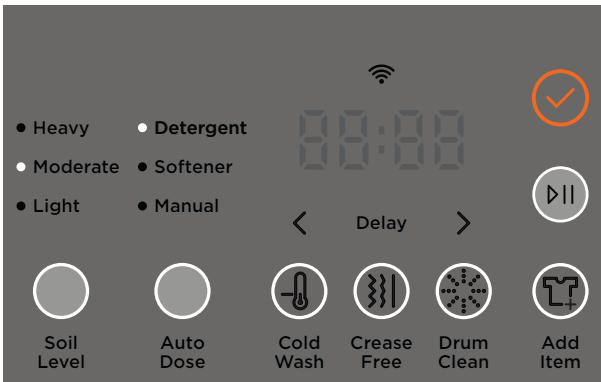

7. Press **CONFIRM** ✓ to confirm settings.

See 'Setting delayed start' if you want to delay the beginning of the wash cycle.

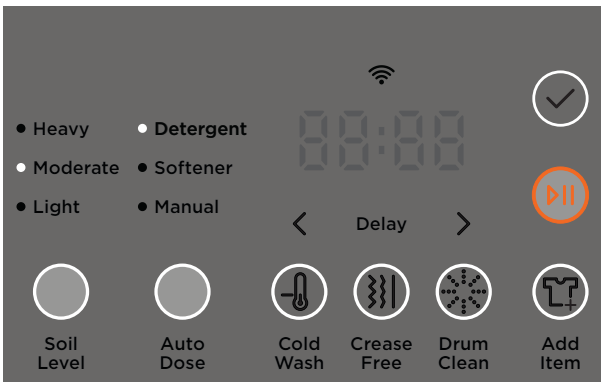

8. Press **START/PAUSE** ⏮⏭ to start the cycle.

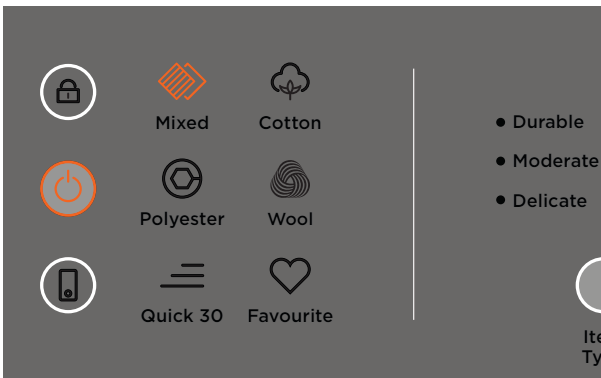

Cancelling the cycle

Press **POWER** ⏻ to turn the washer off and cancel the cycle.

CUSTOMISE CYCLE SETTINGS

You can customise the default cycle settings for each fibre type to save time if you regularly use the same settings.



1. Set your Fibre and other settings that you want to save, and press **CONFIRM** ✓.

Press and hold the selected Fibre button until **5Et** shows on the display and you hear a tone.

The new settings for that fibre type are now saved.

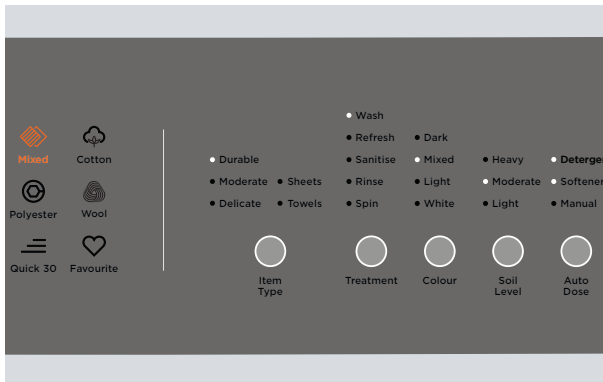

2. At next use, select the fibre type. The new settings will be selected automatically.

Press **CONFIRM** ✓ to confirm settings, then **START/PAUSE** ▶|| to start the cycle.

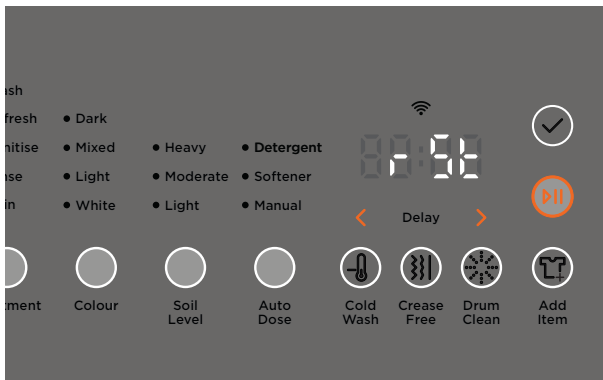

Clear all saved cycles and favourites

Press **FAVOURITE** ♥, then press and hold the arrows < and > until an alert sounds and **5Et** shows on the display.

Press and hold **START/PAUSE** ▶|| to confirm the reset.

This also resets cycles saved in the app.

SAVE FAVOURITE CYCLES

FAVOURITE  is set to **QUICK 15** by default, but you can save a different favourite cycle on the appliance and up to 14 more in the app. See 'Customise cycle settings' for how to reset all favourites.



Save a new Favourite

1. Set your Fibre and other settings as normal, and press **CONFIRM** .



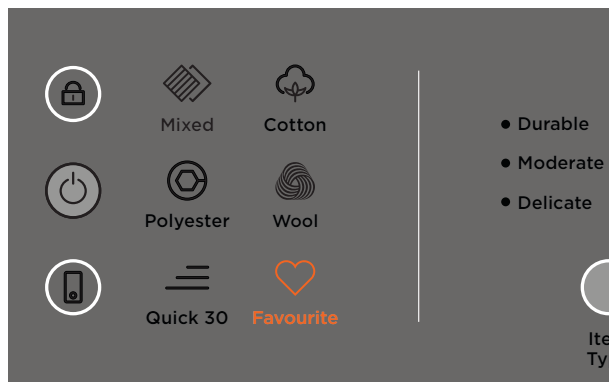

2. Press and hold **FAVOURITE**  until **5Et** shows on the display and you hear a tone.

Your **FAVOURITE** is now saved.



3. To use your saved Favourite, select **FAVOURITE**  instead of **FIBRE**. The other settings will be selected automatically.

Press **CONFIRM** , then **START/PAUSE**  to start the cycle.

SET DELAY START

DELAY START allows you to set a cycle to begin after a set duration.

Times available for selection are 15 minutes, 30 minutes, 1 hour and further increments of an hour up to 12 hours.

The displayed duration is approximate.

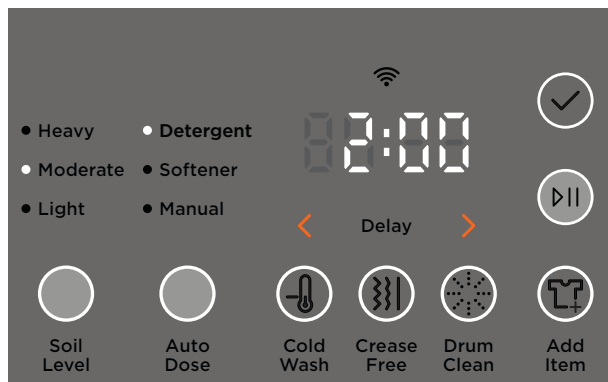

1. After setting and confirming the wash cycle, press **DELAY**, then use the arrows < or > to set your preferred delay duration.

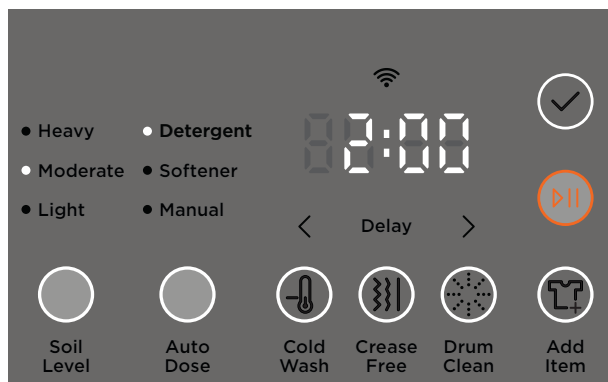

2. Press **CONFIRM** ✓ then **START/PAUSE** ▶|| to start the delay countdown. The wash cycle will begin when the countdown ends.

Press **POWER** ⏻ to turn off the washer and cancel the delay.

WASH OPTIONS

Access extra wash options and optimisers in the app

- **COLD PRE-WASH** - Add a pre wash to remove excess soil and ensure optimal wash results.
- **SOAK** - Use cold wash to minimise energy usage.
- **EXTRA RINSE** - Add an extra rinse to the cycle. Ideal for people with sensitive skin, or for heavily soiled items.
- Optimise the cycle as required to save energy, reduce wash time or reduce noise. Select from **BALANCED, ENERGY, TIME** and **SOUND**.

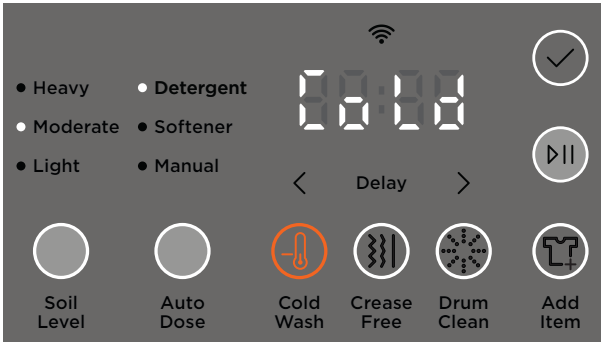

Cold Wash

Press **COLD WASH**  to select a cool wash temperature.

This uses cold inlet water for the cycle to minimise energy usage. Not available on all cycles.

See 'Change Cold Wash default' to fix cold water at 20°C.

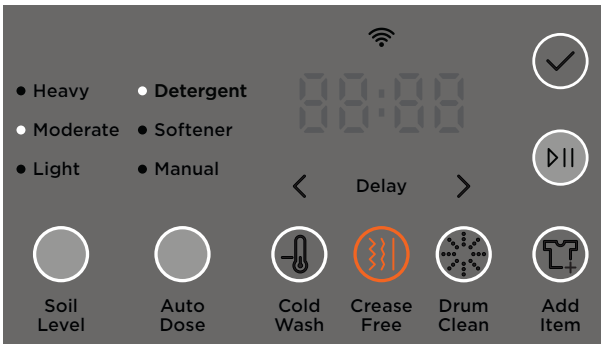

Crease free

Press **CREASE FREE**  to turn **CREASE FREE** on or off.

This tumbles the load periodically after the cycle to reduce creases in items.

Runs for 12 hours or until turned off.



Add Item

Press **ADD ITEM**  to pause the wash and add an item. For best results, add within 10 minutes of starting the cycle. The washer may drain slightly so door can open safely.

Not available on all cycles.

Press **CONFIRM** , then **START/PAUSE**  to resume the cycle.

CHANGE COLD WASH DEFAULT

The default setting for the **COLD WASH**  temperature is determined by the cold water supplied to your washing machine. If you live in a colder climate, you can change the **COLD WASH** temperature to a fixed 20°C so wash performance is not affected.

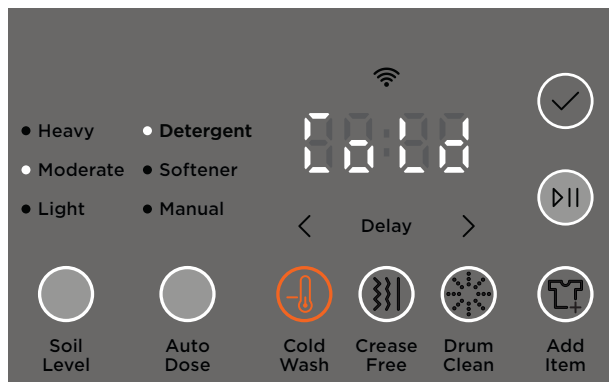

1. Press and hold **COLD WASH**  until **COLD** shows on the display.

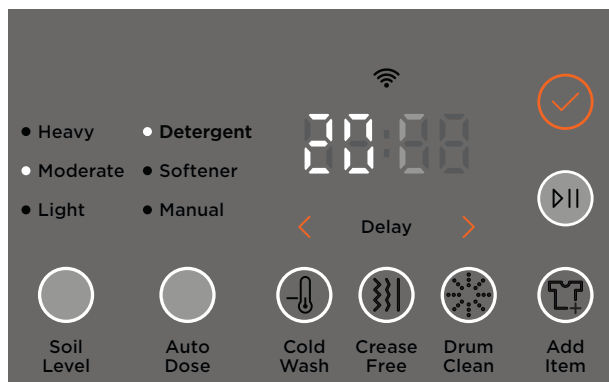

2. Use the delay buttons **<** or **>** to toggle until **20 °C** shows on the display, then press **CONFIRM** .

Repeat the steps to change it back to **COLD**.

ADJUST AUTO DOSE AMOUNT

The default dosage amounts for detergent and softener can be adjusted between five levels from 1 to Hi. Your washer is set by default to level 3 for both detergent and softener.

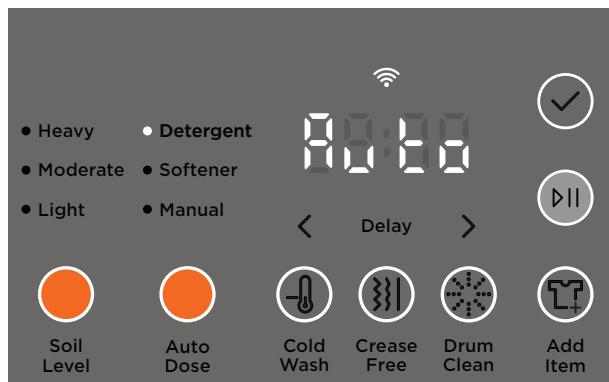

Adjusting Detergent dosage

1. Press and hold **SOIL LEVEL** and **AUTO DOSE** until the display switches from *Auto* to *dEt* to the current dosage. The **DETERGENT** indicator will flash.

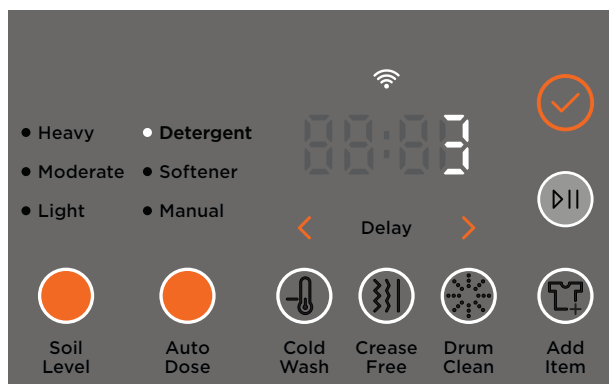

2. Use the arrows < or > to adjust the dosage level from 1 to Hi, then press **CONFIRM** ✓. *SEt* will show on the display.

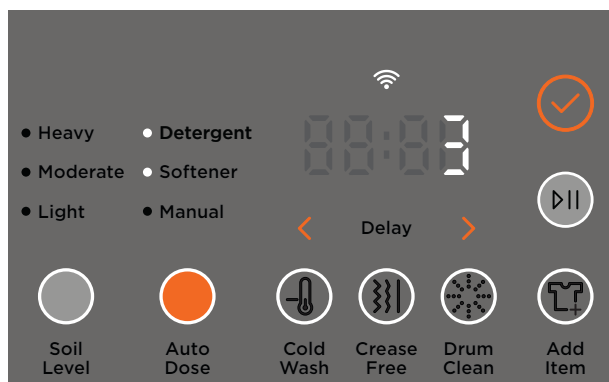

Adjusting Softener dosage

3. Press and hold **SOIL LEVEL** and **AUTO DOSE** until *Auto* shows on the display. Press **AUTO DOSE** to select **SOFTENER**. The display will switch from *Soft* to the current dosage and the **SOFTENER** indicator will flash.

Use the arrows < or > to adjust the dosage level. Press **CONFIRM** ✓ to save new level. *SEt* will show on the display.

WASH TEMPERATURES AND SPIN TREATMENTS

Wash temperatures and spin speeds are set automatically based on your fibre, item type and colour selections. This ensures the best wash results for your items.

See below for how colour selection affects wash temperature and how item type affects spin speed.

WASH TEMPERATURE

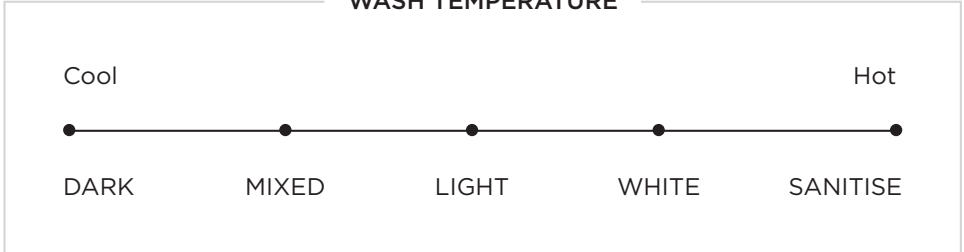

SPIN SPEED

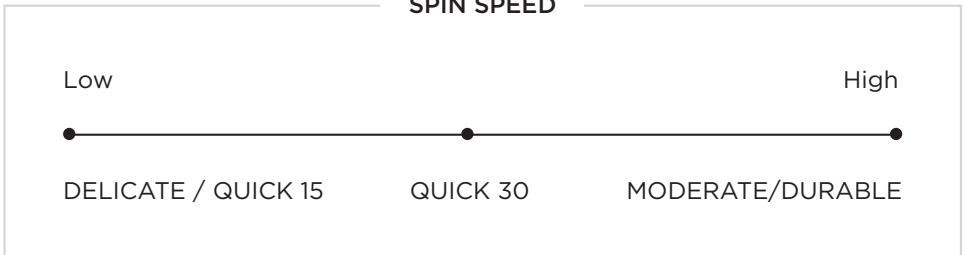

CHOOSE A DETERGENT

Specialised detergents provide the best wash performance for different items. We recommend using a specialised detergent type where relevant.

If switching detergents, we recommend cleaning the dispenser drawer to remove unsuitable detergent before washing items with a new detergent. See 'Clean the dispenser drawer'.

Everyday

For your everyday items that do not require specialised care.

Darks

Dark detergents are specially designed to keep darks vibrant and prevent dye transfer during the wash. Avoid using darks detergents with white or light-coloured items.

Whites

Whites detergents are designed to brighten your white items as they typically contain whitening agents. Avoid using whites detergents with dark-coloured items.

Sensitive

For items of users with sensitive skin. Sensitive detergents are typically free from fragrance and colourants, safer for those with allergies or asthma, and ideal for baby clothes.

Delicates

For delicate and ultra-delicate fabrics. Delicate detergents preserve fibres while maintaining softness.

Wool

Wool detergents are ideal for all types of woollen items to gently clean and maintain softness.

Softener

Softeners are for conditioning items, giving them a softer feel. Softeners are dispensed during the rinse phase to prevent mixing with detergents.

WI-FI CONNECTION AND REMOTE MODE

Your appliance may be connected to your home wireless network and operated remotely using the app. Connect your appliance to ensure it stays up to date with the latest software and features.

Getting started

- Ensure your home Wi-Fi network and Bluetooth on your mobile device are turned on.
- You will be given step-by-step guidance on your mobile device.
- It may take up to 10 minutes to connect your appliance.
- For further guidance and troubleshooting, please refer to the app.

On your mobile device:



- ① Download the app. Scan the QR code or go to www.fisherpaykel.com/connect
- ② Register and create an account.
- ③ Add your appliance and set up the Wi-Fi connection.

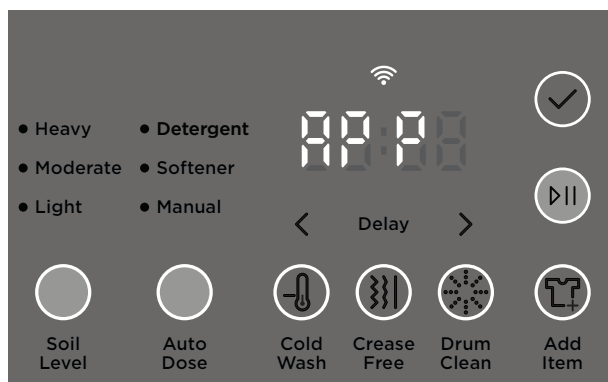

Connecting to Wi-Fi

Press and hold **REMOTE** until *APP* shows on the display and the Wi-Fi indicator starts to flash. Follow the instructions in the app to complete the connection.

Once connected, the Wi-Fi indicator will stop flashing and remain illuminated.

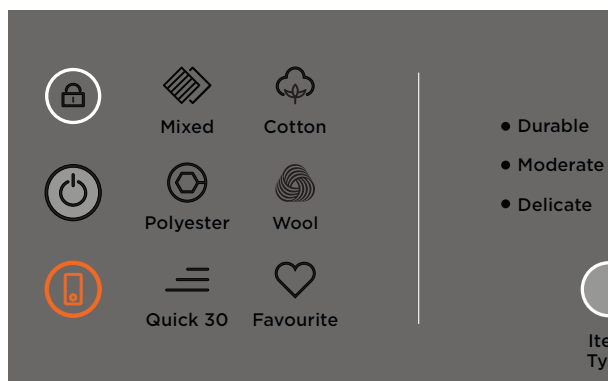

Turning Remote mode on/off

Press **REMOTE**, then press **START/PAUSE** to confirm.

When in remote mode, **REMOTE** will stay illuminated.

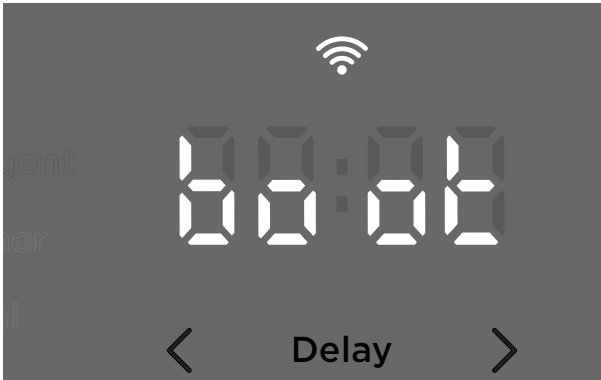

Updating software

You will be notified in the app when a software update is available. Software cannot be updated when the product is running.

Follow the instructions in the app to begin the update. While updating, *baaE* will show on the display.

CLEAN AND MAINTAIN YOUR APPLIANCE

Surfaces and accessories

Wipe with a damp cloth and dishwashing liquid, then dry with a clean, lint-free cloth. We do not recommend using the following cleaning products as they may cause damage:

- Plastic or stainless steel scouring pads
- Abrasive, solvent, household cleaners
- Acid or alkaline cleaners
- Handwash or soap
- Stainless steel cleaners or polishes
- Laundry detergents or disinfectants

Cleaning the drum and the door

- Run a regular Drum Clean cycle.
- Wipe the rubber seal around the door to prevent odours. Remove any items or lint and wipe out any water.
- Remove dirt or lint from the drum and wipe it clean. Do not leave metal objects in the drum as these may rust and cause staining.
- Leave the door open when not in use to prevent odours. Keep children and pets away from the washer so they cannot become trapped inside it.

Cleaning the hose(s)

Each hose contains a filter to stop contaminants in the water from entering your washer. Occasionally, disconnect the hoses where they connect to the taps and wash out any dirt build-up.

Moving your washer

- Remove the dispenser drawer and empty out any detergent or softener. Refer to 'Cleaning the dispenser drawer.'
- Clean the pump filter and ensure any water in the washer is drained. Refer to 'Cleaning the pump filter'.

Products that might damage your washer

- Concentrated bleaches, laundry pre-soakers/sanitisers, stain removers and hydrocarbon solvents (eg petrol and paint thinners) can cause damage to the surfaces eg control panel, and other components of your washer.
- Be careful when washing items stained with solvents as they are flammable. DO NOT put them in your dryer.
- Use of dyes in your washer may cause staining of the plastic components. The dye will not damage the washer but we suggest you thoroughly clean your washer afterwards. We do not recommend the use of dye strippers in your washer.
- Nappy sanitisers and bleach are very corrosive to metal surfaces. DO NOT tip the contents of a nappy bucket into your washer. Rinse and wring items out thoroughly before placing them in the washer.

CLEAN THE DISPENSER DRAWER

Check and clean the dispenser drawer regularly to remove build-up.



1. Pull the dispenser drawer towards you and push down on the tab to the left of the **MANUAL DOSE** compartment. Remove the drawer from the washer.



2. Drain residual detergent, then fill the compartments with warm water and shake lightly to clear residue.

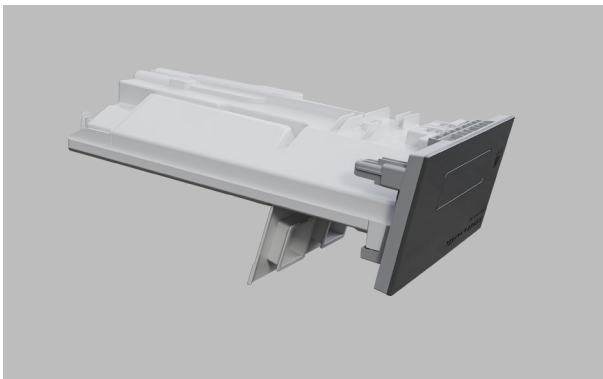

3. Drain all water from the compartments and allow to dry before refitting the dispenser drawer to the washer.

RUN THE DRUM CLEAN CYCLE



DRUM CLEAN is a hot water cycle designed to be used with Washing Machine Cleaner to remove any buildup and odours. A reminder will display after 100 cycles.

Run the drum clean cycle when you see the reminder or more frequently if you use Eco or liquid detergents and low-temperature cycles.

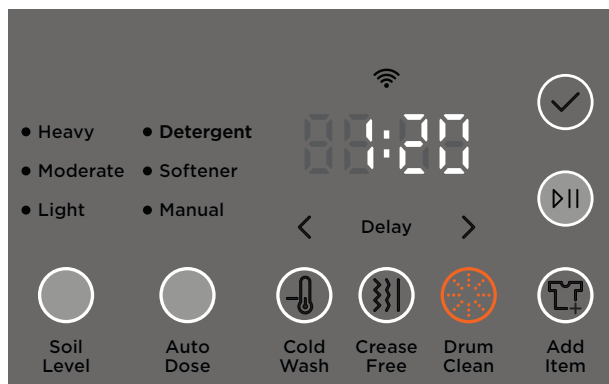

1. Ensure the drum is empty, then add Washing Machine Cleaner directly into the drum. Follow the manufacturer's instructions for recommended dosage.



2. Press **DRUM CLEAN**  to select the cycle. Press **CONFIRM**  then **START/PAUSE**  to start the cycle.

UNLOCK THE DOOR

In a power failure, you can use the door release tab to unlock the washer door and remove items.

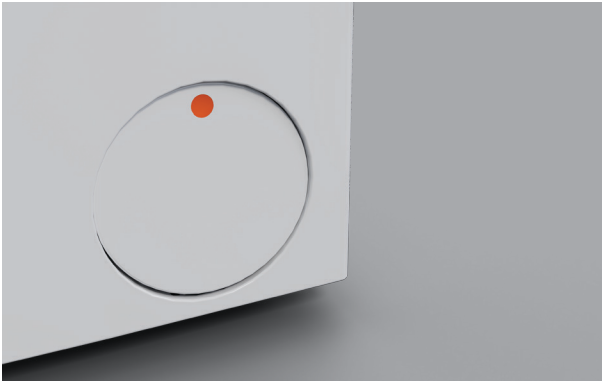

1. Push the centre of the filter cover to open.

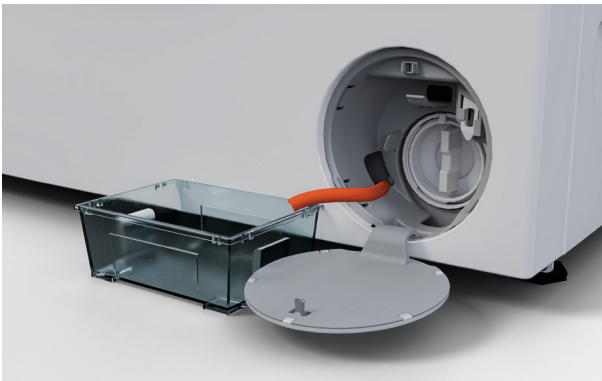

2. Drain the appliance to ensure it is safe to open the door. See 'Clean the pump filter' for details.



3. Use a tool to pull the tab down and release the door.

CLEAN THE PUMP FILTER

Check and clean the pump filter if you notice the washer is not draining. Disconnect washer from the power supply before you remove any parts.

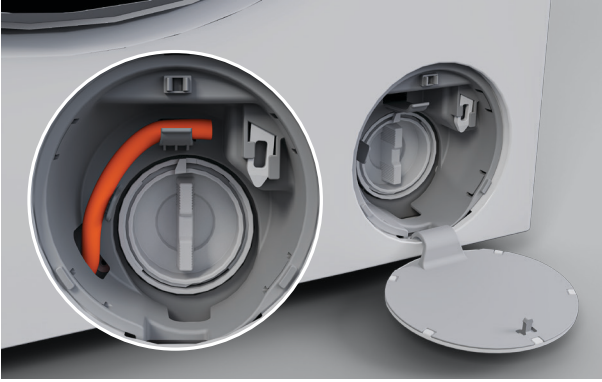

1. Push the centre of the filter cover to open, then unhook the hose and pull it out.

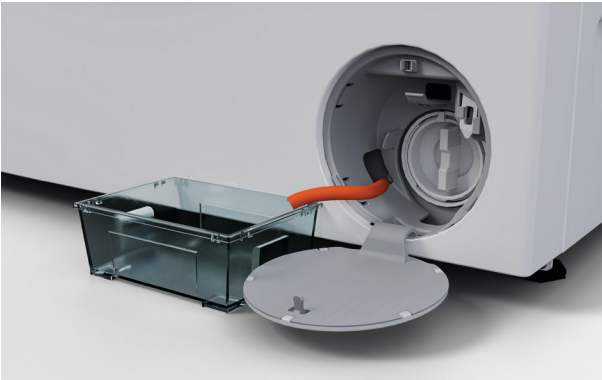

2. Remove the hose plug, and drain water into a shallow dish.
After draining, replace the plug and refit the hose in the housing.



3. Turn the filter anti-clockwise to remove. Some water may leak from it.
Clean and rinse the filter.

CLEAN THE PUMP FILTER

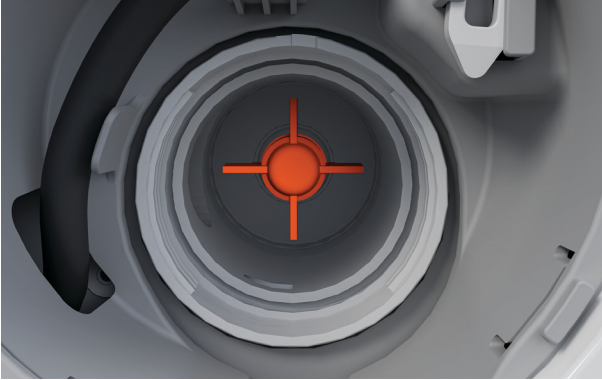

4. Check and clear the cavity behind the filter, and check that the impeller behind the filter moves freely.



5. Refit the filter and turn it clockwise until the handle is in the vertical position.



TROUBLESHOOTING

General use



Why will the appliance not turn on?

- No power. Check the appliance is connected to the power supply. Press **POWER**  to turn the appliance on.
-

Why is the display not responding?

- The controls are locked. Press and hold **LOCK** .
 - Appliance needs to be reset. Press **POWER**  to turn the appliance off. Wait a few seconds, then turn it back on. If the problem persists, disconnect from the power supply, wait a few seconds, then reconnect and press **POWER**  to turn it on.
 - Appliance may require a software update. Connect it to Wi-Fi and check for updates in the app.
-





Why is the washer not starting?

- Door not closed. Check nothing is obstructing the door, and close it firmly.
 - Cycle confirmed but not started. Press the **START/PAUSE**  button to start the cycle.
 - Washer is overloaded. Remove some items and restart the cycle.
 - Delay start is set. See 'Set Delay start'.
 - The controls are locked. Press and hold **LOCK** .
 - There is a fault. See 'Faults and alerts'.
-



Why is the washer stopping and starting?

The **CREASE FREE** setting is turned on. Press **CREASE FREE**  to turn off.

Why did the washer stop mid-cycle?

- Cycle has been paused. Press **CONFIRM**  then **START/PAUSE**  to resume the cycle.
 - The door is open. Close the door and press **CONFIRM**  then **START/PAUSE**  to resume the cycle.
-

Why is the washer vibrating or making noises?

- Transit bolts may still be in place. Refer to installation guide for how to remove them.
 - Washer overloaded. Press **START/PAUSE**  to pause the cycle and remove some items.
 - Washer not level. Refer to installation guide for instructions about levelling the washer.
 - Load out of balance. Press **START/PAUSE**  to pause the cycle and redistribute items.
 - Washer has a fault. See 'Faults and alerts'.
-

TROUBLESHOOTING

Why is the wash cycle taking so long?

- Washer is overloaded. Pause the cycle and remove some items.
 - Items are tangled. Untangle the items and resume the cycle.
 - Incorrect settings for the load. Check the selected fibre type, item type and treatment and adjust if required.
 - Washer is not draining. Check the drain hose for blockages and correct if possible. If the problem persists contact Customer Care.
-



Why is the fabric damaged after a wash cycle?

- Cycle settings not appropriate for the load type. Follow instructions on care labels and sort items accordingly. See 'Sort your items'.
 - Metal parts on the items or in the load may catch on fabric. Always fasten zips, velcro and other clasps before placing items in the washer.
-

Why do items keep getting tangled?

- Loads not separated before going in the washer. Load items individually and try separating larger items from smaller items.
 - Load size is too large. Try washing smaller loads. See 'Load the washer'.
 - Wash big items like sheets and duvet covers separately and use the **Sheets** item type.
 - Cycle settings not the best option for the load type.
 - Delicate items not separated. Wash pantyhose, bras and stockings in a small washbag.
-

Why do items keep getting creased?

- Items have been left in the washer after the cycle ended. Turn **CREASE FREE**  on at the start of the cycle to minimise creasing.
 - Washer is overloaded. Press **ADD ITEM**  to pause the wash and remove some items.
 - Select the **Delicate** item type. This will reduce spin speed and minimise creases.
-

Why is dye transferring between my items?

- Items not sorted before going in the washer. Separate white and coloured items into separate loads.
 - Cycle settings not appropriate for load type. Select the relevant **COLOUR** option for your load.
-

Why is the washer not draining?

- Pump filter needs to be cleaned. See 'Clean the pump filter.'
 - Drain hose not connected correctly. See the installation guide for instructions.
 - Drain hose or drain is blocked. Check the drain hose and drain for blockages and correct if possible. If the problem persists contact Customer Care.
-

TROUBLESHOOTING

Why is the washer beeping?

- The cycle has ended. Items can be removed.
 - Washer has a fault. See 'Fault codes'.
-

Why is water coming from under the washer?

- Door not closed. Check nothing is obstructing the door, and close it firmly.
 - Dispenser drawer not closed. Close it firmly.
 - Drain hose or drain is blocked. Check the drain hose and drain for blockages and correct if possible. If the problem persists contact Customer Care.
 - Drain hose not connected correctly. See the installation guide for instructions.
-

Why is my washing wetter than I expect at the end of the cycle?

- Out of Balance load affecting spin speed. Redistribute the load and run a spin treatment to remove excess water.
 - Quick or delicate cycles have slower spin speed and can result in wetter washing at the end of the cycle. Select Moderate and Durable item types as these have faster and longer spin times.
-

Why are my clothes not as clean as I expected?

- Incorrect settings for the load. Select a higher **SOIL LEVEL**.
 - Not enough detergent. Increase detergent amount by increasing **SOIL LEVEL** or adjusting **AUTO DOSE** amount.
 - Washer overloaded so can't wash items properly. See 'Load the washer' for maximum load capacity guidance.
 - Ineffective detergent. Use a good quality detergent for best results.
 - Washer still has residual dirt from previous wash. After washing particularly soiled clothing, empty the washer and run a **RINSE** cycle to remove residual dirt.
-

Why is the remaining cycle time not accurate?

Cycle time is an estimate based on load size and water flow rates. It adjusts throughout the cycle to give you an estimation of minutes remaining. The time shown is not the Declared Program Time.

Why does my item have wet patches on after a REFRESH cycle?

This is normal and helps remove wrinkles. Remove the item from the washer immediately at the end of the cycle and hang up to dry for a few minutes before wearing.

Why does my washer smell after a cycle?

- Drum and door need to be cleaned. See 'Clean and maintain your appliance'.
 - Try using a different detergent.
 - Leave the washer door open slightly after a cycle so it can dry out.
-



FAULTS AND ALERTS

How do I know if there is a problem?

Your washer will beep and an alert will show in the display.



What to do

First try to fix the issue and clear the alert according to the onscreen instructions or the steps in the following table.

ALERT	WHAT TO DO
LOC	Door is locked. Wait for cycle to end.
KEY LOC	Controls are locked. Press and hold KEY LOCK  to unlock.
OVER FILL	Water level is too high. Cycle will resume when water level goes down.
CLR FLTR	Pump filter is blocked. See 'Clean the pump filter' for how to clean the filter.
DOOR	Door is open. Close door fully.
NO TAP	No water. Check that taps are on and hoses are connected.
NO LOC	Door cannot lock. Press CONFIRM  , then START/PAUSE  to lock the door and start the cycle.
OUT OF BALANCE	App alert only. Out of balance load has reduced spin speed. Redistribute load and run a spin treatment to remove excess water.

'E' fault codes

You may be able to clear the fault by resetting the washer. Follow the steps below:

- ① Press **POWER**  to turn the appliance off.
- ② Wait a few seconds, then **POWER**  to turn the appliance back on.

If the fault code has disappeared, you can continue to use your washer.

If the problem persists

- ③ Note down the fault code.
- ④ Contact Customer Care.

COMPLIANCE INFORMATION

Registration cycle

The cycle for energy and water labelling in accordance with AS/NZS: 2040.2 and AS/NZS:6400 is as follows: Cotton, Item: Durable, Colour: White, AutoDose: Manual. This cycle is the recommended energy and water saving for normally soiled everyday washing, equal to the rated capacity.

Note for Testing Laboratories: The powder detergent is placed directly into the bottom of the drum. The maximum amount of anti-foaming agent is then placed into the bottom of the drum followed by the PBIS solution. The load is then added as per AS/NZS2040.1 requirements.

Hot sanitise

This cycle complies with the bacterial removal requirements of GB 21551.5-2010. Average elimination rate for the following bacteria, Staphylococcus aureus & Escherichia coli >99.9%.
Fibre: MIXED, Item Type: MODERATE: Treatment: SANITISE, Colour: MIXED, Soil Level: MODERATE, AutoDose: MANUAL

Woolmark

The wool wash cycle of this machine has been approved by The Woolmark Company for the washing of machine washable wool products provided that the products are washed according to the instructions on the garment label and those issued by the manufacturer of these washing machines M2529. (WH8060J5, WH9060J5). The capacity of this cycle is 2kg.

Fibre: WOOL, Item Type: DELICATE, Treatment: WASH, Colour: WHITE, Soil Level: LIGHT, AutoDose: MANUAL.



MANUFACTURER'S WARRANTY AND SERVICE GUIDE

NZ



To access your Warranty and Service Guide

Scan the QR code with your smartphone to access your warranty and book a service, or view online at <https://www.fisherpaykel.com/nz/help-and-support/warranty-information>

AU



To access your Warranty and Service Guide

Scan the QR code with your smartphone to access your warranty and book a service, refer to your separate warranty and service book or view online at <https://www.fisherpaykel.com/au/help-and-support/warranty-information>

This product has been designed for use in a domestic (residential) environment. This product is not designed for any commercial use. Any commercial use by the customer will affect this product's Manufacturer's Warranty.

Complete and keep for safe reference:

Model _____

Serial No. _____

Purchase Date _____

Purchaser _____

Dealer _____

Suburb _____

Town _____

Country _____

FISHERPAYKEL.COM

© Fisher & Paykel Appliances 2026. All rights reserved.

The models shown in this guide may not be available in all markets
and are subject to change at any time.

The product specifications in this guide apply to the specific products and
models described at the date of issue. Under our policy of continuous product
improvement, these specifications may change at any time.

For current details about model and specification availability in your country,
please go to our website or contact your local Fisher & Paykel dealer.

433048B 03.26