

Single DishDrawer™ Dishwasher, Tall, Sanitise

Series 9 | Contemporary

Black Stainless Steel



Created with extra height for large dishes and designed to be placed anywhere in your kitchen, for loading dishes with less bending.

- With extra height for taller dishes, and customisable internal shelving
- Six wash programs, as well as additional Quick wash, Sanitise and Extra Dry options

DIMENSIONS

Height	478mm
Width	599mm
Depth	573mm

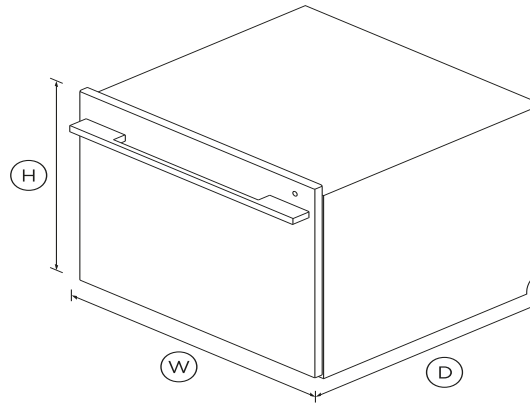

FEATURES & BENEFITS

Ease of use

DishDrawer™ Dishwashers are easy to open and close and can be positioned at bench height for effortless loading and minimal bending. Flexible racking allows you to make adjustments to fit in all kinds of dishes.

Quick, Sanitize and Extra Dry options

The Quick wash modifier delivers a faster wash while maintaining performance. The Sanitise option provides extra protection killing 99.9% of bacteria in the final rinse. The Extra Dry setting is

perfect for plastic dishes.

Quiet performer

Running at a very low decibel rate, these DishDrawer™ Dishwashers do their job without making a fuss. The combination of intelligent technology and simple mechanics means greater reliability and excellent wash performance.

Beauty of choice

As much a design component as a high performance appliance, the black DishDrawer™ Dishwasher brings a touch of sophistication to your kitchen, on its own or part of a matching kitchen appliance set.

SPECIFICATIONS

Accessories

- Cutlery basket
- Kickstrip
- Knife clip and multipurpose

Capacity and loading

Accommodates round plates	310mm
Adjustable height, foldable	•
Fold down tines	•
Pitch adjustable tines	•

Consumption

Energy rating	3.5 star
Energy usage	136kWh/year
In-use energy carbon	88.6kgCO2e/year
Water consumption (per wash)	6.9L
Water efficiency	4.5 star (WELS)

Controls

- Electronic fault/Diagnostic
- End of cycle beeps
- Energy saving delay start
- Internal wash selector
- Keylock
- Rinse aid indicator light
- Wi-Fi connectivity

Features

- Fan assisted drying
- Flood protection
- Flow through detergent
- Quiet operation
- SmartDrive™ technology

Performance

Noise emissions **42dBA**

Power requirements

Amperage **5A**
 Supply frequency **50Hz**
 Supply voltage **220 - 240V**

Product dimensions

Depth **573mm**
 Height **478mm**
 Width **599mm**

Warranty

Parts and labour **2 years**

Wash Program Modifiers

- Extra Dry
- Quick
- Sanitise
- Wash modifiers **3**

Wash Programs

- Delicate
- Eco
- Fast
- Heavy
- Medium
- Rinse
- Wash programs **6**

Water connection

Water pressure **30kPa - 1000 kPa**
 Water supply **3/4" BSP (20mm) Connector**

SKU **82327**

The product dimensions and specifications in this page apply to the specific product and model. Under our policy of continuous improvement, these dimensions and specifications may change at any time. You should therefore check with Fisher & Paykel's Customer Care Centre to ensure this page correctly describes the model currently available. ? Fisher & Paykel Appliances Ltd 2020

Other product downloads available at fisherpaykel.com

- [↓ Service & Warranty](#)
- [↓ User Guide DishDrawer™ Dishwasher](#)
- [↓ Quick Start Guide DishDrawer™ Dishwasher EN](#)
- [↓ Wash Program Data ASNZS DishDrawer™ Dishwasher](#)
- [↓ Energy & Water Label DishDrawer™](#)
- [↓ Energy and Water Label](#)
- [↓ Installation Guide Single DishDrawer™ Dishwasher](#)
- [↓ Installation Guide Single DishDrawer™ Dishwasher](#)



A PEACE OF MIND SALE

24 Hours 7 Days a Week Customer Support

T 1300 650 590 W www.fisherpaykel.com