

Top Loader Washing Machine, 8.5kg

Series 7 | Top Load

White



With room for large loads, this top loader runs on SmartDrive™ technology for a quieter, quicker wash.

- 12 wash cycles including Allergy, Sports and Wool, and a 30 minute Quick cycle to cater to busy lives
- Energy saving with Eco-Active™
- 4 star energy and 3.5 star water rating

DIMENSIONS

Height	1045 - 1075mm
Width	600mm
Depth	600mm

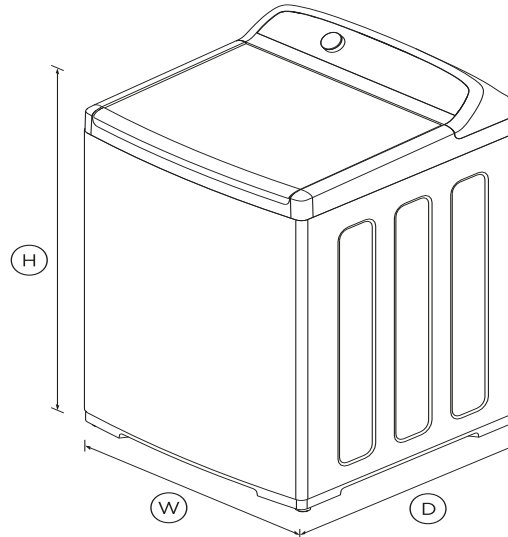

FEATURES & BENEFITS

SmartDrive™ Technology

Our world-first SmartDrive™ technology is made up of just three main parts. This means our washing machines can sense each load, use less water and run with less moving parts for greater reliability.

Fast full load

Fast cycle times allow you to wash a full 8.5kg load in as little as 59 minutes.

Eco-Active™ wash

Eco-Active™ recirculates water and detergent through clothes so less hot water is used to remove stains, dirt and bacteria.

Easy to use

This machine has a cycle to suit every type of load including Delicate, Sports and Wool. Select a cycle with the easy to use SmartTouch™ control dial.

Easy installation

Self-levelling feet make installation easy and ensure the washer stays level, to reduce vibration and keep noise to a minimum.

Perfect pair

Our washing machines and dryers make the perfect pair. Not only do they care for your clothes, they also look stylish together in your laundry.

Soft-close lid

The tough glass lid delivers quality and durability. Its soft close mechanism makes it family safe, avoids slamming and allows for hands-free operation.

SPECIFICATIONS

Consumption

Energy rating	4 star
Energy usage	313kWh/year
In-use energy carbon	42.4kgCO2e/year
Water consumption per cycle	96L
Water efficiency	3.5 star (WELS)

Features

Adjustable alert beeps	•
Agitator	Flexible finned
Auto out of balance correction	•
Automatic water level	•

Child/Keylock	•
Controlled cold	•
Delay start	•
Detergent dispenser	•
Eco rinse	•
Fabric softener dispenser	•
Lid lock	•
No spin / Spin Hold	•
Rinse options	5
SmartTouch™ control dial	•
Soak	•
Soil levels	3
Spin speeds	3
Stainless steel drum	•
Water temperature controls	5

Performance

Auto-Lint disposal	•
Load sensing	•
Maximum spin speed	1100rpm
Number of spin speeds	3
SmartDrive™ technology	•

Product dimensions

Depth	600mm
Height	1045 - 1075mm
Height (Lid open)	1350 - 1380mm
Width	600mm

Warranty

Parts and labour	2 years
Parts only SmartDrive™ Motor	10 years

Wash Cycles

Allergy	•
Bulky	•
Conventional	•
Delicate	•
Easy Iron	•
Eco-Active™	•
Heavy	•
Number of wash cycles	12
Quick	•
Regular	•
Rinse	•
Spin	•
Sports	•
Wool	•

SKU	93262
-----	-------

The product dimensions and specifications in this page apply to the specific product and model. Under our policy of continuous improvement, these dimensions and specifications may change at any time. You should therefore check with Fisher & Paykel's Customer Care Centre to ensure this page correctly describes the model currently available. ? Fisher & Paykel Appliances Ltd 2020

Other product downloads available at fisherpaykel.com

- [↓](#) User Guide
- [↓](#) Service & Warranty
- [↓](#) Installation Guide



A PEACE OF MIND SALE

24 Hours 7 Days a Week Customer Support

T 0800 372 273 Wwww.fisherpaykel.com