

Combination Microwave Oven, 60cm

Series 9 | Contemporary

Stainless Steel



The speed of microwave cooking with the versatility of convection oven technology in a companion model, for perfect pairing.

- 37L total capacity
- 10 different auto cooking modes including Defrost , plus convection cooking or Grill
- Part of our suite of companion products, designed to match aesthetically for flexible configurations.

DIMENSIONS

Height	458mm
Width	596mm
Depth	562mm

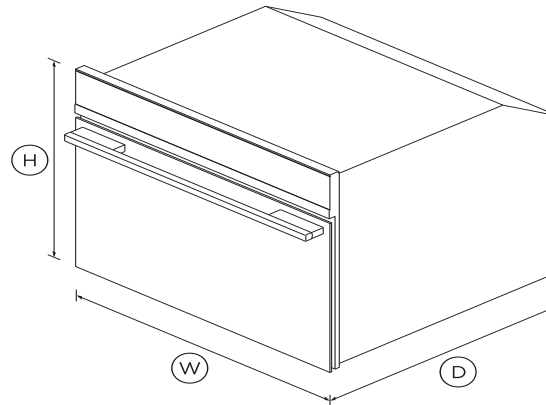

FEATURES & BENEFITS

Sized to suit

A compact 60cm width means this Microwave Oven can be placed almost anywhere - all companion products can be installed at a convenient height to suit your kitchen design and preference.

Cooking flexibility

Choice of nine cooking modes including Fan Forced and Grill, giving you the best of microwave and convection oven technology.

Easy to use

An easy-to-use, intuitive display gives you all the information you need, including a cooking guide with nine pre-selected food cooking recipes.

Complementary design

Finished in black reflective glass with a polished metal trim, this Microwave Oven is designed to match the other companion products and the rest of Fisher & Paykel's kitchen family.

Safe & sound

The CoolTouch door is safe to touch from the outside, protecting your hands and the surrounding cabinetry.

Easy cleaning

This Microwave Oven has formed side racks and a stainless steel interior that are easy to clean.

SPECIFICATIONS

Accessories

Baking pan	1
Glass turntable	1
Wire shelf	1

Accessories (sold separately)

Handle kit Contemporary	Optional round handle
Optional 76cm trim kit	Part 81883
Optional round handle	Part 81671

Capacity

Shelf positions	3
Total capacity	37L
Usable capacity	33L

Cleaning

- Easy clean stainless steel
- Easy to clean formed side

Consumption

Microwave energy **1.65kWh**

Controls

- Audio feedback
- Automatic cooking/minute
- Celsius/Fahrenheit
- Electronic capacitive touch
- Electronic oven control
- Intuitive touchscreen display

Functions

- Defrost by time
- Defrost by weight
- Fan forced
- Fan grill
- Grill
- Microwave + grill
- Microwave + ring
- Microwave cooking
- Number of functions **9**
- Ring + grill

Performance

Grill power **1500W**
 Microwave power **900W**

Microwave power levels **6**

Power requirements

Amperage **15A**
 Supply frequency **60Hz**
 Supply voltage **220V**

Product dimensions

Depth **562mm**
 Height **458mm**
 Width **596mm**

Safety

- Control panel key lock
- CoolTouch door

Warranty

Parts and labour **2 years**

SKU **82302**

The product dimensions and specifications in this page apply to the specific product and model. Under our policy of continuous improvement, these dimensions and specifications may change at any time. You should therefore check with Fisher & Paykel's Customer Care Centre to ensure this page correctly describes the model currently available. ? Fisher & Paykel Appliances Ltd 2020

Other product downloads available at fisherpaykel.com

- ↓ Service & Warranty
- ↓ User Guide
- ↓ Installation Guide
- ↓ Installation Guide - Cavity Trim Kit
- ↓ Data Sheet Combination Microwave Oven

**A PEACE OF MIND SALE**

24 Hours 7 Days a Week Customer Support

T 1300 650 590 Wwww.fisherpaykel.com