

# Freestanding French Door Refrigerator Freezer, 32", 17 cu ft, Ice & Water

Series 7 | contemporary

Stainless Steel | French hinge



Designed for those who need plenty of flexible space for their cold and frozen food storage, with a stylish stainless steel finish.

- ActiveSmart™ technology helps keep food fresher for longer by constantly maintaining the ideal temperature
- Spacious bottom freezer with full extension drawer gives easy access to frozen goods

## DIMENSIONS

Height	67 <sup>17</sup> / <sub>32</sub> "
Width	31 <sup>3</sup> / <sub>32</sub> "
Depth	27 <sup>3</sup> / <sub>8</sub> "

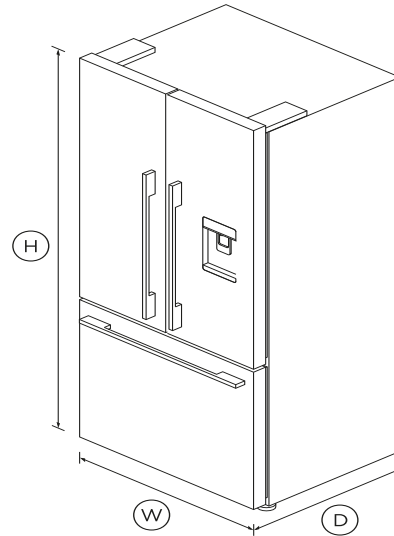

## FEATURES & BENEFITS

### ActiveSmart™ Foodcare

ActiveSmart™ Foodcare learns how you live. It's technology which understands how you use your fridge and adjusts temperature, airflow and humidity inside to help keep food fresher for longer.

### Design quality

Our refrigerators are designed and built using quality materials. We use real stainless steel on our refrigerators and solid glass for shelving.

### Water on tap

The slimline dispenser makes it easy to fill almost any sized jug or vessel with cool filtered water and doesn't take up any storage space in your refrigerator.

### Clever energy

Your refrigerator adapts to daily use by cooling and defrosting only when needed. This means your refrigerator uses the energy it needs without compromising on food care.

### Ice maker

Fresh ice is always available for you in a dedicated freezer bin. Simply turn it off to free up freezer space or during busy times, you can boost ice production by up to 30%.

### Humidity control

Your fruit and veges need different environments. The humidity control slides in each storage bin create a microclimate that helps keep food fresher for longer.

### Easy cleaning

No more permanent dirty marks with our EZKleen feature for stainless steel refrigerators. Anti-fingerprint coating means you simply wipe clean any marks. Spill-safe secure glass shelves easily capture any drips or leaks.

## SPECIFICATIONS

### Accessories (sold separately)

Contemporary round handle kit	<b>Part number 25376</b>
Matching Replacement Water	<b>Part number 847200</b>

### Capacity

Freezer	<b>4.8cu ft</b>
Refrigerator	<b>12.1cu ft</b>

### Consumption

Energy usage **585kWh/year**

**Freezer features**

- Bottle chill •
- Built-in ice maker •
- Fast freeze •
- Ice Boost •
- Large plastic bin •
- Small plastic bins **2**

**Performance**

- ActiveSmart™ Foodcare •
- ActiveSmart™ technology •
- Adaptive defrost •
- Frost free freezer •
- Humidity control system •
- Sabbath mode •

**Product dimensions**

Depth **27 <sup>3</sup>/<sub>8</sub> "**

Height **67 <sup>17</sup>/<sub>32</sub> "**

Minimum air clearance - at rear **1-<sup>3</sup>/<sub>16</sub>" "**

Minimum air clearance - each **<sup>13</sup>/<sub>16</sub>" "**

Width **31 <sup>3</sup>/<sub>32</sub> "**

**Refrigerator features**

- Adjustable door shelves **6**
- Adjustable glass shelves **3**
- Covered door shelves **2**
- Door alarm •

- Fruit and vegetable bins **2**
- SmartTouch control panel •
- Soft close doors •
- Stackable bottle holders **4**
- Ultra slim water dispenser •







**Warranty**

- Parts and labor **2 years**
- Sealed system parts only **5 years**

SKU **25065**

The product dimensions and specifications in this page apply to the specific product and model. Under our policy of continuous improvement, these dimensions and specifications may change at any time. You should therefore check with Fisher & Paykel's Customer Care Centre to ensure this page correctly describes the model currently available. Â© Fisher & Paykel Appliances Ltd 2019.

**Other product downloads available at fisherpaykel.com**

-  [User Guide](#)
-  [Service & Warranty Booklet](#)
-  [Guide D'Utilisation](#)
-  [Installation Guide](#)
-  [Installation Guide \(Quick Reference\)](#)
-  [Guide D'Installation](#)
-  [Resources \(zip\)](#)



**A PEACE OF MIND SALE**

**24 Hours 7 Days a Week Customer Support**

**T 1300 650 590 W www.fisherpaykel.com**