

Wall Rangehood, 90cm, Pyramid Chimney

Series 5 | Contemporary

Stainless Steel



The wall chimney rangehood has contemporary styling, extracting steam, grease and cooking odours quietly and efficiently.

- With three fan speeds, select the perfect extraction rate for your cooking
- Powerful maximum air movement of 780m³/hr
- Dishwasher safe filters that are easy to remove and clean

DIMENSIONS

Height	610-1050mm
Width	898mm
Depth	500mm

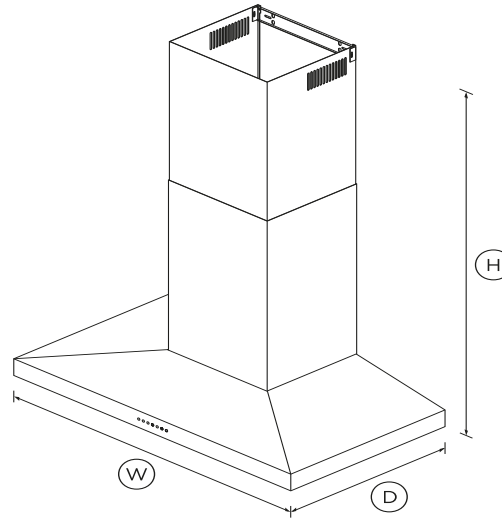

FEATURES & BENEFITS

Easy installation

This wall chimney rangehood is the perfect partner to your Fisher & Paykel cooktop. It can be either externally ducted or internally recirculated, making it perfect for apartments.

Simple To Use

Three fan speeds provide powerful extraction to ensure steam and odours are quickly removed. Simply change the fan speed with the touch of a button.

Easy cleaning

Three filters effectively trap grease particles during extraction. They are easy to remove and dishwasher safe, or can be cleaned by hand in hot soapy water.

Complementary design

This wall chimney rangehood's sleek stainless steel finish which will complement any contemporary kitchen and is designed to match the rest of Fisher & Paykel's kitchen appliance family.

SPECIFICATIONS

Accessories

Aluminium filter	792527
------------------	--------

Accessories (sold separately)

Chimney extension	792492 (Cover duct extension
Eave ducting kit	PD-RHK150E
Light bulb	792461
Recirculation carbon filter	792481
Recirculation diverter	791820
Roof ducting kit	PD-RHK150T
Side wall ducting kit	PD-RHK150W

Fan ratings

Maximum air movement	780m ³ /hr
Maximum sound rating	65dBA

Installation and cleaning

Dishwasher safe filters	3
Ducted	Top extraction
Recirculation	Optional - top extraction

Two piece height adjustable •

The product dimensions and specifications in this page apply to the specific product and model. Under our policy of continuous improvement, these dimensions and specifications may change at any time. You should therefore check with Fisher & Paykel's Customer Care Centre to ensure this page correctly describes the model currently available. ? Fisher & Paykel Appliances Ltd 2020

Performance

Extraction type	Surface
Fan speeds	3
Filter type	Mesh
Number of filters	3

Power requirements

Supply frequency	50Hz
Supply voltage	220-240V

Product dimensions

Depth	500mm
Height	610-1050mm
Width	898mm

Product information

Control type	Push Button
--------------	-------------

Ventilation features

Light type	LED
------------	-----

Warranty

Parts and labour	2 years
------------------	---------

SKU	50007
-----	-------

Other product downloads available at fisherpaykel.com



Service & Warranty



User/Installation Guide - Chimney Pyramid Rangehood



A PEACE OF MIND SALE

24 Hours 7 Days a Week Customer Support

T 0800 372 273 W www.fisherpaykel.com