

# Series 5, Contemporary Built-under Dishwasher

Series 5 | Contemporary

Black Stainless Steel

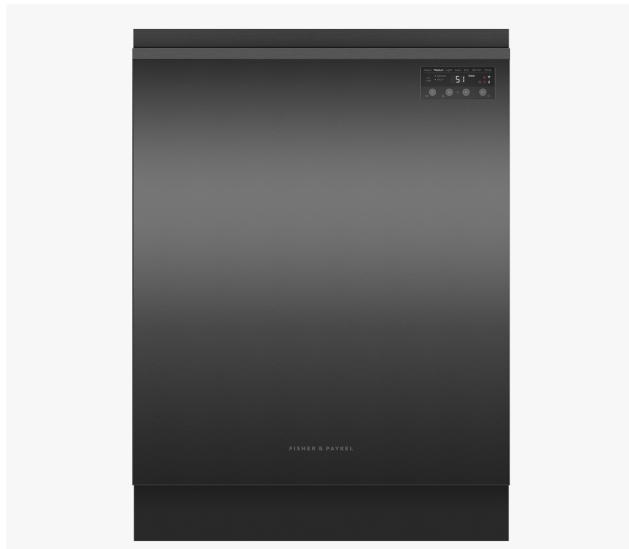

Designed to fit flush under your benchtop for a seamless look, this dishwasher delivers extra wash options and Auto Door Open Dry.

- Designed to be built under your benchtop, fitting flush with cabinetry for a seamless look
- Seven wash programs from Heavy to Light, including Auto, 60min and Eco
- Dry+, Sanitise and Half Load modifiers provide extra wash options

- Wi-Fi enabled and works with the SmartHQ™ app for remote control and notifications

## DIMENSIONS

Height	820 - 880 mm
Width	597 mm
Depth	574 mm

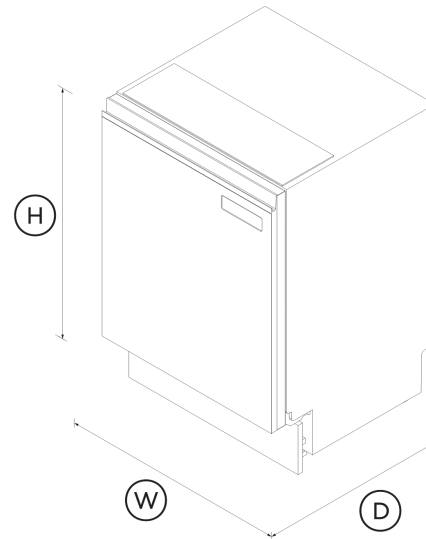

## FEATURES & BENEFITS

### Seamless Design

Install this dishwasher flush under your benchtop with minimal gaps. Designed to match our Contemporary family of appliances with a recessed handle for a seamless finish in your kitchen.

### Effortless Drying

For beautifully dry dishes every time, this dishwasher features the Auto Door Open Dry function. This function automatically releases excess steam at the end of the cycle, ensuring dishes are immediately ready for use or storage. An innovative air curtain channels the steam away from the adjacent benchtop, protecting your cabinetry.

### A Reliable Clean

This dishwasher offers seven wash programs including Auto, which automatically senses the optimal wash settings for your dishes. The three-stage filtration system delivers a superior clean, while the rinse aid indicator reminds you to top up for beautifully clean dishes.

### Customise Your Wash

The Half Load modifier is perfect for washing a partial load, for faster turnaround of dishes. Sanitise provides extra protection, killing 99.9% of bacteria\* in the final rinse, while the Dry+ modifier is great for plastic dishes.

\*Certified to NSF/ANSI Standard 184

### Efficient Performance

With a 4 star energy rating and 5 star water rating, this dishwasher delivers a powerful wash. Use the Eco wash program for optimal water and energy consumption, or choose when the cycle begins with Delay Start.

### Flexible Loading

Designed to fit 15 place settings with ease, adjustable racks help you to load and care for various items - including a height-adjustable upper basket, and foldable cup holders and tines.

## SPECIFICATIONS

### Accessories (included)

Cutlery basket	•
Kickstrip	true

**Capacity and loading**

Accommodates round plates up to (lower basket)	<b>320mm</b>
Accommodates round plates up to (top basket)	<b>250mm</b>
Adjustable height, foldable cupracks	•
Easy lift adjustable upper basket	•
Fold down tines	•
Place settings	<b>15</b>
Place settings	<b>15</b>

**Consumption**

Energy rating	<b>4 star</b>
Energy usage	<b>246kWh/year</b>
In-use energy carbon emissions estimate	<b>23.4kgCO2e/year</b>
Water consumption (per wash cycle)	<b>12.2L</b>
Water rating	<b>5 star (WELS)</b>

**Controls**

Energy saving delay start option of up to 12 hours	•
Keylock	•
Rinse aid indicator light	•
Smart appliance	•
Time remaining LED display	•

**Features**

Air curtain for bench protection	•
Aquastop	•

Auto Door Open Dry	•
Flood protection	•
Half load option	•
Internal tub material	<b>Stainless Steel</b>
Motor type	<b>Asynchronous</b>
ThermoDry system	•
Three-stage filtration system	•

**Performance**

Noise emissions	<b>46 dBA</b>
-----------------	---------------

**Power requirements**

Amperage	<b>10A</b>
Supply frequency	<b>50Hz</b>
Supply voltage	<b>220 - 240V</b>

**Product dimensions**

Depth	<b>574 mm</b>
Height	<b>820 - 880 mm</b>
Width	<b>597 mm</b>

**Warranty**

Parts and labour	<b>2 years</b>
------------------	----------------

**Wash Program Modifiers**

Dry +	•
-------	---

Half load	•
Sanitise	•
Wash modifiers	<b>3</b>

**Wash Programs**

60 min	•
Auto	•
Eco	•
Heavy	•
Light	•
Medium	•
Rinse	•
Wash programs	<b>7</b>

**Water connection**

Water pressure	<b>30kPa - 1000 kPa</b>
Water supply	<b>3/4" BSP (20mm) Connector Water Inlet Hose</b>

SKU	<b>82430</b>
-----	--------------

The product dimensions and specifications in this page apply to the specific product and model. Under our policy of continuous improvement, these dimensions and specifications may change at any time. You should therefore check with Fisher & Paykel's Customer Care Centre to ensure this page correctly describes the model currently available. © Fisher & Paykel Appliances Ltd 2020

**Other product downloads available at fisherpaykel.com**

- [↓](#) 2D-DWG Dishwasher
- [↓](#) 2D-DXF Dishwasher
- [↓](#) Data Sheet Dishwasher
- [↓](#) Energy & Water Label Dishwasher
- [↓](#) Service & Warranty
- [↓](#) Installation Guide Built-Under Dishwasher
- [↓](#) User Guide Dishwasher
- [↓](#) Wash Program Data Dishwasher

**Where applicable:**

All appliances use energy, and energy usage typically generates carbon emissions. **Fisher & Paykel Appliances' In-use Energy Carbon Emissions Estimate** indicates carbon emissions from a product's in-use energy. This is calculated either annually or per cycle, using the product's market-specific energy label energy consumption data multiplied by the carbon emissions factor for energy in your country or region.

Our In-use Energy Carbon Emissions Estimate is designed to assist customers in making informed purchasing decisions when comparing different Fisher & Paykel products. For example, a heat pump dryer typically has a lower In-use Energy Carbon Emissions Estimate than a vented dryer.



**A PEACE OF MIND SALE**  
**24 Hours 7 Days a Week Customer Support**  
T 0800 372 273 **W**www.fisherpaykel.com