

Freestanding Cooker, Induction, 90cm, 5 Zones with SmartZone, Self-cleaning

Series 9 | Classic

Stainless Steel



With large oven and cooktops that can be paired to create an expansive cook zone, this freestanding cooker is made for those who love to cook.

- Five cooking zones that can be bridged to form SmartZones
- Convection oven with 140L total capacity, nine oven functions plus rotisserie, including Pastry Bake with pizza mode and rapid proof for making bread
- Non-tip full-extension shelves for safe removal of hot dishes

- High-temperature self-cleaning function breaks down food residue for an easy clean

DIMENSIONS

Height	898 - 946mm
Width	897mm
Depth	600mm

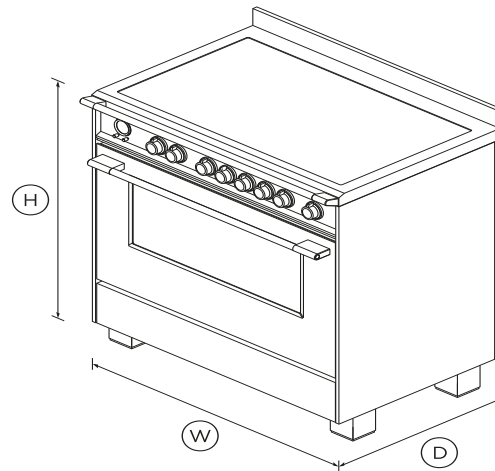

FEATURES & BENEFITS

Multi-Shelf Cooking

Our AeroTech™ system circulates air evenly throughout the entire oven so dishes on the top shelf turn out just as perfectly as food cooking on the bottom shelf.

Quality And Durability

Every detail has been carefully crafted. The solid, perfectly

balanced soft-close door, durable cooktop and glowing halo dials all add up to an exceptional, premium range.

POWER & CONTROL

Instant and immediate control from the highest to the gentlest heat. The finely tuned cooktop controls let you sear, stir fry or simmer a delicate sauce to perfection.

Easy To Clean

Cleaning up spills is effortless. Your cooktop simply needs a quick wipe to keep it looking good as new. The pyrolytic self-clean oven cycle breaks down food residue at a very high temperature, leaving a light ash that's easily removed with a damp cloth.

Even Heat

Accurate, electronically-controlled oven heat ensures a great result every time.

LARGE CAPACITY OVEN

The generous 140L total capacity oven gives you plenty of space to cook multiple dishes at once.

Large, Flexible Cooking Area

SmartZone links two cooking zones and controls them as one, giving you the flexibility to use large pans and griddles and easily handle bigger food items such as a whole fish.

SPECIFICATIONS

Accessories

Flat wire shelf	1
Full extension sliding shelves	2 sets (part 578744)
Full extension telescopic	2 sets (part 578744)
Grill rack	•
Roasting dish	1
Rotisserie set	1 set
Step down wire shelf	•

Accessories (sold separately)

Kick strip, black (optional)	KICKOR90B1
Kick strip, red (optional)	KICKOR90R1
Kick strip, stainless steel	KICKOR90X1
Kick strip, white (optional)	KICKOR90W1

Capacity

Shelf positions	6
Shelf positions (main oven)	6
Total capacity	140L
Usable capacity	120L

Cleaning

Acid resistant graphite enamel	•
Drop down grill element	•
Flat easy clean glass surface	•
Pyrolytic self-clean	•
Removable oven door	•
Removable oven door inner	•
Removable shelf runners	•

Controls

Audio feedback	•
Automatic cooking/minute	•
Automatic pre-set	•
Celsius/Fahrenheit	•
Electronic clock	•
High resolution display	•
Laser etched graphics	•

Precise electronic temperature	•
Sabbath mode	•
Toughened fused glass	•
Turned stainless steel clock	•
Turned stainless steel clock	•

Oven features

AeroTech™ technology	•
Automatic rapid pre-heat	•
Bright chromed, cast zinc dials	•
Convection	•
Electronic oven control	•
Full extension telescopic	•
Internal light	4 x 25W halogen (2 side & 2
Soft open/close door	•
Twin cavity fans	•
Warming drawer	•

Oven functions

Bake	•
Fan bake	•
Fan forced	•
Fan grill	•
Grill	•
Number of functions	9
Pastry Bake with Pizza mode	•
Rapid proof	•
Roast	•
Rotisserie	•

Oven performance

CoolTouch door	Quadruple glazed
Warming drawer power	202W

Power requirements

Amperage	68A
Supply frequency	50Hz
Supply voltage	220 - 240V

Product dimensions

Depth	600mm
Height	898 - 946mm
Width	897mm

Cooktop Features

Auto heat reduce	•
Dual colour display	•
Gentle heat	•
Heat settings	9
Hob rail	•
Induction cooking technology	•
SmartZone	1
Zone bridging	•

Cooktop Performance

Centre	2300W
Left front	1600W
Left rear	2100W
Number of cooking zones	5
PowerBoost	•

Safety

- Advanced cooling system •
- Anti-tilt bracket •
- Balanced oven door •
- Catalytic venting system •
- Child lock •
- CoolTouch door •
- Full extension telescopic **2 sets (part 578744)**
- Full extension telescopic •
- Non-tip shelves •
- Pan detection system •
- Safety time out •
- Spillage auto off •
- Surface hot indicators •

Warranty

Parts and labour **2 years**

SKU 81693

data multiplied by the carbon emissions factor for energy in your country or region.

Our In-use Energy Carbon Emissions Estimate is designed to assist customers in making informed purchasing decisions when comparing different Fisher & Paykel products. For example, a heat pump dryer typically has a lower In-use Energy Carbon Emissions Estimate than a vented dryer.

Other product downloads available at fisherpaykel.com

- [↓](#) Service & Warranty
- [↓](#) User Guide Freestanding Cooker
- [↓](#) Installation Guide - Kick Strip
- [↓](#) Installation Guide Freestanding Cooker



A PEACE OF MIND SALE

24 Hours 7 Days a Week Customer Support

T 1300 650 590 W www.fisherpaykel.com

The product dimensions and specifications in this page apply to the specific product and model. Under our policy of continuous improvement, these dimensions and specifications may change at any time. You should therefore check with Fisher & Paykel's Customer Care Centre to ensure this page correctly describes the model currently available. Fisher & Paykel Appliances Ltd 2020

Where applicable:

All appliances use energy, and energy usage typically generates carbon emissions. **Fisher & Paykel Appliances' In-use Energy Carbon Emissions Estimate** indicates carbon emissions from a product's in-use energy. This is calculated either annually or per cycle, using the product's market-specific energy label energy consumption