

# Integrated Column Refrigerator, 76cm

Series 11 | Integrated

Right Hinge | Panel Ready



Install it separately or pair with another Column for true design freedom - this model is right hinge with stainless steel interior.

- ActiveSmart™ technology helps keep food fresher for longer by constantly maintaining the ideal temperature.
- Variable Temperature Zone lets you change a compartment to Fridge, Pantry or Chill for optimal storage
- Customise with your own kitchen cabinetry or purchase our stainless steel door panel accessory

## DIMENSIONS

Height	2134mm
Width	756mm
Depth	610mm

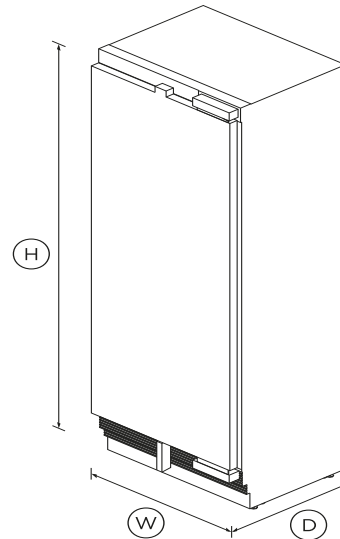

## FEATURES & BENEFITS

### Mix & match

Integrated Column Refrigeration gives you the freedom to mix and match. Different sized Column Fridges and Freezers can be installed separately or paired. Finish them with our stainless steel door panels or customise to match your own kitchen cabinetry.

### Perfect fit

These models fit flush, with only 3mm gaps around them and no visible hinges or grilles. Our Integrated Column models can be seamlessly hidden behind your cabinetry, or you can purchase

our stainless steel door panel.

### Clever energy

Our ActiveSmart™ Foodcare Fridge Freezers adapt to daily use by cooling and defrosting only when needed. This means your fridge uses the energy it needs without compromising on food care.

### Appealing illumination

Bright LEDs light up each ceiling, shelves, bins and trays in both refrigerator and freezer, making it easy to find your food and creating a welcoming glow in your kitchen for those midnight snacks.

### Design quality

The premium design and quality finish includes a steel interior lining as well as full extension metal shelf runners for easy access, and robust glass shelving.

### Easy install

Integrated Column Refrigerators and Freezers have been developed to make their installation easy. The joiner kit is included when pairing refrigerators and freezers. All models come with front adjustable levelling feet and they've been designed to easily slide into place as separate units.

## SPECIFICATIONS

### Accessories

1220mm Stainless steel toe	25395
1372mm Stainless steel toe kick	25397
1524mm Stainless steel toe	25399
762mm Stainless steel toe kick	25391
Contemporary round handle	25324
Contemporary square handle	25322
Joiner kit	25328
Stainless steel door panel	25315

---

<b>Capacity</b>	
Total gross	<b>498L</b>
Volume	<b>463L</b>

---

<b>Consumption</b>	
Energy rating	<b>3.5 star</b>
Energy usage	<b>227kWh/year</b>

---

<b>Features</b>	
Adjustable door shelves	<b>4</b>
Adjustable glass cantilevered	<b>3</b>
Covered door shelves	<b>1</b>
Door alarm	<b>•</b>
Gallon door shelves	<b>1</b>
LED bin lighting	<b>•</b>
LED ceiling lighting	<b>•</b>
LED side lighting	<b>•</b>
SmartTouch interface at	<b>•</b>
Soft-close fruit and vegetable	<b>•</b>
Stackable bottle holders	<b>4</b>

---

<b>Installation Dimensions</b>	
Minimum inside width of	<b>762mm</b>
Minimum internal depth of	<b>635mm</b>
Minimum internal height of	<b>2134mm</b>

---

<b>Performance</b>	
ActiveSmart™ Foodcare	<b>•</b>
ActiveSmart™ technology	<b>•</b>

Dual evaporator	<b>•</b>
Humidity control system	<b>•</b>
Inverter controlled compressor	<b>•</b>
Sabbath mode	<b>•</b>
Variable food modes	<b>Pantry; Fridge; Chill</b>
Variable temperature zones	<b>2</b>

---

<b>Power requirements</b>	
Rated current	<b>10A</b>
Supply frequency	<b>50Hz</b>
Supply voltage	<b>230V</b>

---

<b>Product dimensions</b>	
Depth	<b>610mm</b>
Height	<b>2134mm</b>
Width	<b>756mm</b>

---

<b>Product information</b>	
Packaged weight	<b>156kg</b>
Unpackaged weight	<b>133kg</b>

---

<b>Warranty</b>	
Parts and labour	<b>2 years</b>

---

SKU	<b>26162</b>
-----	--------------







---

& Paykel's Customer Care Centre to ensure this page correctly describes the model currently available. ? Fisher & Paykel Appliances Ltd 2020

TEST The product dimensions and specifications in this page apply to the specific product and model. Under our policy of continuous improvement, these dimensions and specifications may change at any time. You should therefore check with Fisher

---

Other product downloads available at [fisherpaykel.com](http://fisherpaykel.com)

-  User Guide
-  User Guide
-  Service & Warranty
-  Installation Guide
-  Installation Guide
-  Installation Guide



**A PEACE OF MIND SALE**

24 Hours 7 Days a Week Customer Support

T 1300 650 590 [Wwww.fisherpaykel.com](http://www.fisherpaykel.com)