

90cm Series 9 Contemporary Pyrolytic Oven

Contemporary



This Series 9 oven provides ample capacity for diverse cooking needs, featuring nine functions including Pastry Bake, Rotisserie, and Fan Bake.

- Generous 100L total capacity, with nine oven functions
- Pyrolytic self-cleaning function breaks down food residue for an easy clean
- Built-in professional grade rotisserie

DIMENSIONS

Height	478 mm
Width	895 mm
Depth	564 mm

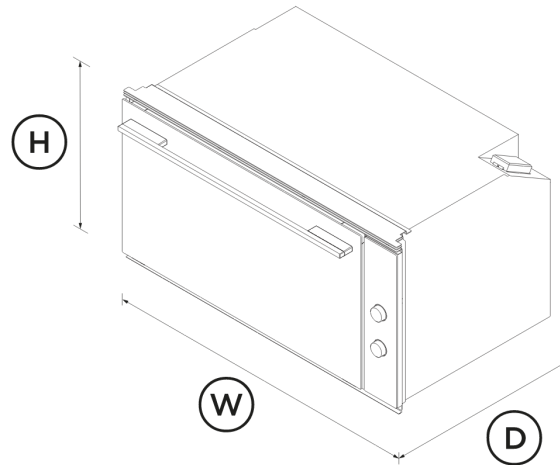

FEATURES & BENEFITS

Cooking flexibility

This built-in oven has nine functions with pre-set temperatures, including Bake, Pastry Bake, and Fan Forced, allowing you to use a variety of cooking styles.

Optimal Performance

Oven functions are pre-set with a simple touch of a dial. Enhanced by brilliant lighting and a large viewing window, the need to open the oven door is minimised, ensuring perfect cooking results while maintaining the oven's internal temperature.

Generous Capacity

Designed for multi-shelf cooking, this built-in oven provides a 100L total capacity. The wide cavity allows for both side-by-side and multi-shelf cooking.

Self-Cleaning

Our self-clean technology breaks down food residue at a very high temperature, leaving a light ash that's easily removed with a damp cloth. The enamel coated side racks don't need to be removed when using this function.

Even cooking

Our ovens feature AeroTech™, a technology that circulates heat evenly, ideal for multi-shelf cooking. The professional-quality rotisserie roasts meat to succulent perfection, and a powerful grill ensures even and quick browning results.

Complementary design

With their premium handle styling and stylish stainless steel finish, our built-in ovens are designed to match the rest of Fisher & Paykel's kitchen appliance family.

SPECIFICATIONS

Accessories (included)

Flat brushed baking tray	1
Grill rack	1 set
Roasting dish	1
Rotisserie set	1
Step down wire shelf	1
Telescopic sliding runners	1 set

Capacity

Total capacity	100 L
Usable capacity	85 L

Cleaning

- Acid resistant graphite enamel
- Drop down grill element
- Pyrolytic self-clean
- Removable oven door
- Removable oven door inner glass
- Removable side ladders

Controls

- Audio feedback
- Automatic cooking/minute timer
- Automatic pre-set temperatures
- Electronic capacitive touch controls
- Electronic clock

Functions

- Bake
- Fan bake
- Fan forced
- Fan grill
- Grill
- Pastry Bake
- Pyrolytic self-clean
- Roast
- Rotisserie

Performance

- AeroTech™ technology

Grill power **4050 W**

Power requirements

Amperage **21 A**

Product dimensions

Depth **564 mm**

Height **478 mm**

Width **895 mm**

Safety

- Balanced oven door
- CoolTouch door
- Non-tip shelves

SKU **84897**

The product dimensions and specifications in this page apply to the specific product and model. Under our policy of continuous improvement, these dimensions and specifications may change at any time. You should therefore check with Fisher & Paykel's Customer Care Centre to ensure this page correctly describes the model currently available. © Fisher & Paykel Appliances Ltd 2020

Other product downloads available at fisherpaykel.com

[↓](#) DWG

- [↓](#) DXF
- [↓](#) Installation Guide (English)
- [↓](#) Planning Guide (English)
- [↓](#) Revit
- [↓](#) Rhino
- [↓](#) SketchUp
- [↓](#) User Guide (English)

Where applicable:

All appliances use energy, and energy usage typically generates carbon emissions. **Fisher & Paykel Appliances' In-use Energy Carbon Emissions Estimate** indicates carbon emissions from a product's in-use energy. This is calculated either annually or per cycle, using the product's market-specific energy label energy consumption data multiplied by the carbon emissions factor for energy in your country or region.

Our In-use Energy Carbon Emissions Estimate is designed to assist customers in making informed purchasing decisions when comparing different Fisher & Paykel products. For example, a heat pump dryer typically has a lower In-use Energy Carbon Emissions Estimate than a vented dryer.



A PEACE OF MIND SALE
24 Hours 7 Days a Week Customer Support
 T 1300 650 590 www.fisherpaykel.com