

Oven, 60cm, 7 Function

Series 5 | Contemporary

Stainless Steel



With contemporary styling and clean lines in glass and steel, this built-in oven complements the style and elegance of any modern kitchen.

- 55L total capacity
- Seven oven functions including Pastry Bake

DIMENSIONS

Height	458mm
Width	597mm
Depth	565mm

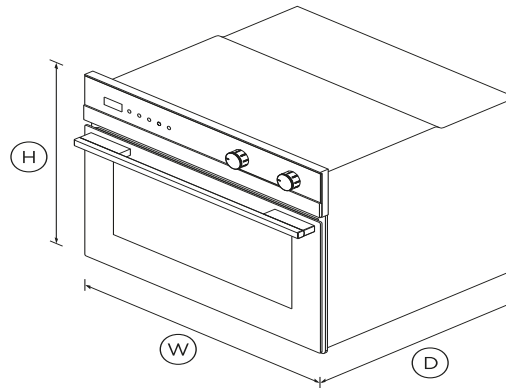

SPECIFICATIONS

Accessories

Catalytic panels	•
Grill rack	1 set
Roasting dish	1
Step down wire shelf	1
Telescopic sliding runners	1 set

Capacity

Shelf positions	4
Total capacity	55L
Usable capacity	45L

Cleaning

Acid resistant graphite enamel	•
Drop down grill element	•
Removable oven door inner	•
Removable shelf runners	•

Controls

Automatic cooking/minute	•
Electronic capacitive touch	•
Electronic clock	•
Halogen lights	•

Functions

Bake	•
Classic bake	•
Fan bake	•
Fan forced	•
Fan grill	•
Grill	•
Number of functions	7
Pastry Bake	•

Performance

AeroTech™ technology	•
Grill power	3000W
Whisper quiet cooking	•

Power requirementsAmperage **15A**

Product dimensionsDepth **565mm**Height **458mm**Width **597mm**

Safety

Balanced oven door •

CoolTouch door •

Non-tip shelves •

WarrantyParts and labour **2 years**

SKU **81498**

Other product downloads available at fisherpaykel.com[Service & Warranty](#)[User Guide Wall Oven](#)[Installation Guide Built-In Oven](#)[Data Sheet Oven](#)**A PEACE OF MIND SALE****24 Hours 7 Days a Week Customer Support****T 1300 650 590 W www.fisherpaykel.com**

The product dimensions and specifications in this page apply to the specific product and model. Under our policy of continuous improvement, these dimensions and specifications may change at any time. You should therefore check with Fisher & Paykel's Customer Care Centre to ensure this page correctly describes the model currently available. ? Fisher & Paykel Appliances Ltd 2020