

**FISHER & PAYKEL**

**MICROWAVE OVEN**

---

**OM60 model**

**USER GUIDE**

**NZ AU GB IE SG**



## CONTENTS

---

|                          |    |
|--------------------------|----|
| Safety and warnings      | 2  |
| Introduction             | 15 |
| First use                | 16 |
| User preference settings | 21 |
| Starting your oven       | 24 |
| Cooking mode tables      | 25 |
| Traditional cooking      | 26 |
| Automatic cooking        | 27 |
| Microwave cooking        | 29 |
| Recipes                  | 34 |
| Troubleshooting          | 37 |
| Warranty and service     | 39 |

---

### **IMPORTANT!**

### **SAVE THESE INSTRUCTIONS**

The models shown in this user guide may not be available in all markets and are subject to change at any time. For current details about model and specification availability in your country, please go to our website [fisherpaykel.com](http://fisherpaykel.com) or contact your local Fisher & Paykel dealer.

Installation

**⚠ WARNING!**



**Electrical shock hazard**

**Before carrying out any work on the electrical section of the appliance, it must be disconnected from the mains electricity supply.**

**Connection to a good ground wiring system is absolutely essential and mandatory.**

**Alterations to the domestic wiring system must only be made by a qualified electrician. Failure to follow this advice may result in electrical shock or death.**

**⚠ WARNING!**



**Fire hazard**

**Do not use adapters, reducers, or branching devices to connect this appliance to the mains power supply.**

**Failure to follow this advice may result in overheating, burning, or fire.**

**⚠ WARNING!**



**Cut Hazard**

**Take care - some edges are sharp.**

**Failure to use caution could result in injury or cuts.**

## **IMPORTANT SAFETY INSTRUCTIONS!**

- **Save these instructions for the local inspectors use.**
- **To avoid hazard, follow these instructions carefully before installing or using this appliance.**
- **Please make this information available to the person installing the appliance - doing so could reduce your installation costs.**
- **This oven is to be installed and connected to the electricity supply only by an authorised person.**
- **If the installation requires alterations to the domestic electrical system, call a qualified electrician. The electrician should also check that the socket cable section is suitable for the electricity drawn by the oven.**
- **The oven must be earthed.**
- **Installation must comply with your local building and electricity regulations.**
- **This appliance must be installed and connected to the mains power supply only by a suitably qualified person according to these installation instructions and in compliance with any applicable local building and electricity regulations.**  
**Failure to install the appliance correctly could invalidate any warranty or liability claims.**
- **If the power supply cable is damaged, it must be replaced by the manufacturer, its service agent or similarly qualified person in order to avoid a hazard.**
- **A circuit breaker is recommended.**
- **Do not use adaptors, reducers or branching devices to connect the oven to the mains electricity supply, as they can cause overheating and burning.**
- **Make sure the cavity is completely sealed with no gaps. This is to ensure the oven cooling system functions correctly.**

## SAFETY AND WARNINGS

---

### Operation

Your oven has been carefully designed to operate safely during normal cooking procedures. Please keep the following safety instructions in mind when you are using it:

### **WARNING!**



**Electrical Shock Hazard**  
**Turn the oven off at the wall before replacing the oven lamp.**  
**Failure to follow this advice may result in electrical shock or death.**

## IMPORTANT SAFETY INSTRUCTIONS!

- **To reduce the risk of fire, electrical shock, injury to persons or damage when using the oven, follow the important safety instructions listed below:**
- **Read all the instructions before using the oven. Use the oven only for its intended purpose as described in these instructions.**
- **Proper installation: be sure your appliance is properly installed and earthed by a qualified technician.**
- **Isolating switch: make sure this oven is connected to a circuit which incorporates an isolating switch providing full disconnection from the power supply.**
- **Household appliances are not intended to be played with by children.**
- **Do not leave children alone. Children should not be left alone or unattended in the area where the appliance is in use. They should never be allowed to sit or stand on any part of the appliance.**
- **Only use utensils that are suitable for use in microwave ovens.**
- **When heating food in plastic or paper containers, keep an eye on the oven due to the possibility of ignition.**

## IMPORTANT SAFETY INSTRUCTIONS!

- **Children of less than 8 years old must be kept away from the appliance unless continuously supervised. This appliance can be used by children aged from 8 years and above, and persons with reduced physical, sensory or mental capabilities or lack of experience and knowledge, if they have been given supervision or instruction concerning the use of the appliance in a safe way and they understand the hazards involved. Cleaning and user maintenance shall not be done by children without supervision.**
- **Do not place heavy objects on the oven door.**
- **Wear proper apparel. Do not wear loose fitting or hanging garments when using the appliance. They could ignite or melt if they touch an element or hot surface and you could be burned.**
- **In addition, avoid using acid or alkaline substances (such as lemon, vinegar, salt, tomatoes, etc.). Avoid using products containing chlorine, acids or abrasives, especially for cleaning painted parts.**
- **This appliance is intended to be used in household and similiar applications such as:**
  - **staff kitchen areas in shops, offices and other working environments;**
  - **farm houses;**
  - **by clients in hotels, motels and other residential environments;**
  - **bed and breakfast type environments.**
- **The microwave oven is intended for heating food and beverages. Drying of food or clothing and heating of warming pads, slippers, sponges, damp cloth and similiar may lead to risk of injury, ignition or fire.**

## IMPORTANT SAFETY INSTRUCTIONS!

- **User servicing: do not repair or replace any part of the appliance unless specifically recommended in the manual. All other servicing should be referred to a qualified technician.**
- **Do not use water on grease fires. Smother the fire or flame or use a dry chemical or foam type extinguisher.**
- **Use only dry oven mitts or potholders. Moist or damp potholders on hot surfaces could result in burns from steam. Do not let potholders touch hot areas or heating elements. Do not use a towel or a bulky cloth for a potholder. It could catch fire.**
- **Do not heat unopened food containers. They can build up pressure that may cause the container to burst and result in injury.**
- **Safe food handling: leave food in the oven for as short a time as possible before and after cooking. This is to avoid contamination by organisms which may cause food poisoning. Take particular care during warm weather.**
- **Always keep oven vents unobstructed.**
- **Do not operate your appliance by means of an external timer or separate remote control system.**
- **Caution: hot air can blow from the vent at the base of the oven as part of the oven' cooling system.**
- **Placement of oven shelves: always position shelves in the desired location while the oven is cool (before preheating). If a shelf must be removed while the oven is hot, do not let the oven mitts or potholder contact hot heating elements in the oven or the base of the oven.**
- **The contents of feeding bottles and baby food jars shall be stirred or shaken and the temperature checked before consumption, in order to avoid burns.**



## IMPORTANT SAFETY INSTRUCTIONS!

- **Do not clean the oven seal or use any oven-cleaning products on it. It is essential for a good seal, which ensures that the oven operates efficiently. Care should be taken not to rub, damage or move it.**
- **Do not use oven cleaners, harsh/abrasive cleaning agents, waxes, or polishes. No commercial oven cleaner, oven liner, or protective coating of any kind should be used in or around any part of the oven. Do not use harsh/abrasive cleaners, scourers or sharp metal scrapers to clean the oven door glass since they scratch the surface, which may result in the glass shattering.**
- **Clean only the parts listed in this manual.**
- **Eggs in their shells and whole hard-boiled eggs should not be heated in microwave ovens since they may explode, even after microwave heating has ended.**
- **Do not store things children might want above the oven. Children could be burned or injured while climbing on the oven to retrieve items.**
- **Do not install or operate the appliance if it is damaged or not working properly. If you receive a damaged product, contact your dealer or installer immediately.**
- **Do not operate microwave oven while empty.**
- **WARNING: If the door or door seals are damaged, the oven must not be operated until it has been repaired by a competent person.**
- **WARNING: It is hazardous for anyone other than a competent person to carry out any service or repair operation that involves the removal of a cover which gives protection against exposure to microwave energy.**

## IMPORTANT SAFETY INSTRUCTIONS!

- **WARNING:** Liquids and other foods must not be heated in sealed containers since they are liable to explode.
- Do not use the oven if the door or the seals of the door are damaged.  
The oven may not be used until it is repaired by a qualified service technician.
- Use only bakeware approved for oven use. Follow the bakeware manufacturer's instructions.
- The oven must be cleaned regularly and all food residues must be removed.
- Failure to keep the oven clean could cause deterioration of the surfaces that could reduce the life of the appliance and cause dangerous conditions.
- Do not use rough abrasives or sharp metal scrapers to clean the glass door of the oven because they could scratch the surface and cause the glass to shatter.
- Do not use steam cleaners to clean the appliance.
- Never use enamelled baking dishes in the microwave because it could cause a technical breakdown.
- The cooking chamber must only be cooled with the door closed. Check that nothing is stuck on the door of the appliance. Even if the door is only ajar, nearby cabinets can be damaged over time.
- Do not rest or lean on the open door of the appliance and do not put dishware or accessories on it.
- If smoke is observed, switch off or unplug the appliance and keep the door closed in order to stifle any flames.

# SAFETY AND WARNINGS

## Unsuitable dishware

The flat grill must be removed when using the microwave and combined modes. Use it only with traditional oven functions.

- Testing dishware: never turn on the microwave oven before you have put in the food. The only exception allowed is testing dishware.
- Pots and pans: use plates and crockery that are microwave safe.
- Packaging: never heat food covered in tin foil.

## Beverages

- To avoid delayed boiling when heating liquids, always put a spoon in the container.

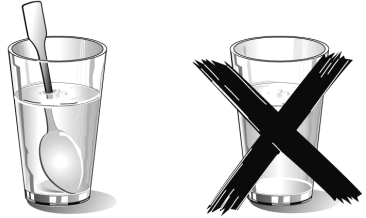

## WARNING!

**Beverages containing spoons should be placed in the centre of the glass turntable. Metal components must stay at least 2 cm from the walls of the oven and the inside of the door. Sparks could damage the inside of the glass door.**

The oven's identification plate is accessible when the appliance is installed. This identification plate, which is visible when you open the door, shows all the information you will need when requesting replacement parts for the appliance.

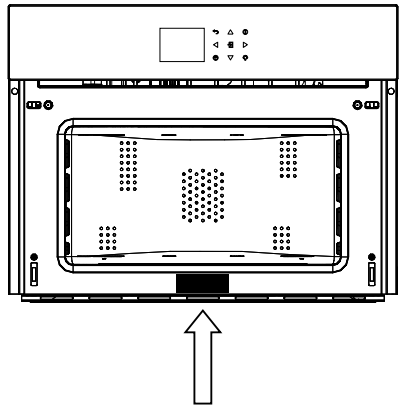

## IMPORTANT SAFETY INSTRUCTIONS!

- **To reduce the risk of fire in the microwave oven cavity:**
  - **Do not overcook food. Carefully attend appliance when paper, plastic or other combustible materials are placed inside the microwave oven to facilitate cooking.**
  - **Remove wire twist-ties from paper or plastic bags before placing bag in microwave oven.**
  - **If materials inside the microwave oven should ignite, keep microwave oven door closed, turn microwave oven off and disconnect the power cord or shut off power at the fuse or circuit breaker panel.**
  - **Do not use the cavity for storage purposes. Do not leave paper products, cooking utensils or food in the cavity when not in use.**
- **Liquids, such as water, coffee or tea are able to be overheated beyond the boiling point without appearing to be boiling. Visible bubbling or boiling when the container is removed from the microwave oven is not always present. THIS COULD RESULT IN VERY HOT LIQUIDS SUDDENLY BOILING OVER WHEN A SPOON OR OTHER UTENSIL IS INSERTED INTO THE LIQUID.**

## **IMPORTANT SAFETY INSTRUCTIONS!**

**To reduce the risk of injury to persons:**

- **Do not overheat the liquid.**
- **Stir the liquid both before and halfway through heating it.**
- **Do not use straight-sided containers with narrow necks. Use a wide-mouthed container.**
- **After heating, allow the container to stand in the microwave oven for at least 20 seconds**
- **before removing the container.**
- **Use extreme care when inserting a spoon or other utensil into the container.**
- **If the microwave oven is installed as a built-in, observe the following instructions:**
  - **Do not mount over a sink.**
  - **Do not store anything directly on top of the appliance surface when the appliance is in operation.**
- **If the microwave oven light fails, consult a Fisher and Paykel authorised servicer.**

# INFORMATION YOU NEED TO KNOW

### About microwave cooking

- Arrange food carefully. Place thickest areas towards outside of dish.
- Watch cooking time. Cook for the shortest amount of time indicated and add more as needed. Food severely overcooked can smoke or ignite.
- Cover foods while cooking. Check recipe or cookbook for suggestions: paper towels, wax paper, microwave plastic wrap or a lid. Covers prevent spattering and help foods to cook evenly.
- Shield with small flat pieces of aluminum foil any thin areas of meat or poultry to prevent overcooking before dense, thick areas are cooked thoroughly.
- Stir foods from outside to center of dish once or twice during cooking, if possible.
- Turn foods over once during microwaving to speed cooking of foods such as chicken and hamburgers. Large items like roasts must be turned over at least once.
- Rearrange foods such as meatballs halfway through cooking both from top to bottom and from the center of the dish to the outside.
- Add standing time. Remove food from microwave oven and stir, if possible. Cover for standing time which allows the food to finish cooking without overcooking.
- Check for doneness. Look for signs indicating that cooking temperatures have been reached.  
Doneness signs include:
  - Food steams throughout, not just at edge.
  - Center bottom of dish is very hot to the touch.
  - Poultry thigh joints move easily.
  - Meat and poultry show no pinkness.
  - Fish is opaque and flakes easily with a fork.

# INFORMATION YOU NEED TO KNOW

| <b>UTENSILS &amp; COVERINGS</b>   | <b>MICROWAVE ONLY</b>   | <b>CONVECTION BROIL, SLOW COOK</b> | <b>HIGH MIX/ROAST LOW MIX/BAKE</b>  |
|---|---|------------------------------------|---|
| <b>Aluminum foil</b>  | YES. Small flat pieces of aluminum foil placed smoothly on food can be used to shield areas from cooking or defrosting too quickly. Keep foil at least 25mm from walls of oven. | NO                                 | NO  |
| <b>Aluminum containers</b>  | YES. Can be used if $\frac{3}{4}$ filled with food. Keep 25mm away from walls and do not cover with foil.   | YES. Broil-No cover                | YES. Can be used if $\frac{3}{4}$ filled with food. Keep 25mm away from walls and do not cover with foil. |
| <b>Browning dish</b>  | YES. Do not exceed recommended preheating time. Follow manufacturer's directions.   | NO                                 | NO  |
| <b>Glass ceramic (Pyroceram®)</b>   | YES. Excellent.   | YES. Excellent.                    | YES. Excellent.   |
| <b>Glass, heat-resistant</b>  | YES. Excellent.   | YES. Excellent.                    | YES. Excellent.   |
| <b>Glass, non-heatresistant</b>   | NO  | NO                                 | NO  |
| <b>Lids, glass</b>  | YES   | YES. Broil-No cover                | YES   |
| <b>Lids, metal</b>  | NO  | YES. Broil-No cover                | NO  |
| <b>Metal cookware</b>   | NO  | YES                                | YES. Do not use metal covering.   |
| <b>Metal, misc: dishes with metallic trim, screws, bands, handles. Metal twist ties</b> | NO  | NO                                 | NO  |
| <b>Oven cooking bags</b>  | YES. Good for large meats or foods that need tenderising. DO NOT use metal twist ties.  | YES. Broil-No cover                | YES. DO NOT use metal twist ties.   |
| <b>Paper plates</b>   | YES. For reheating.   | NO                                 | NO  |

# INFORMATION YOU NEED TO KNOW

| <b>UTENSILS &amp; COVERINGS</b>          | <b>MICROWAVE ONLY</b>   | <b>CONVECTION BROIL, SLOW COOK</b>                            | <b>HIGH MIX/ROAST LOW MIX/BAKE</b>        |
|--|---|---|---|
| <b>Paper towels</b>                      | YES. To cover for reheating and cooking. Do not use recycled paper towels which may contain metal filings.  | NO  | NO  |
| <b>Paper, ovenable</b>                   | YES   | YES. For temperatures up to 205°C. Do not use for broiling.   | YES. For temperatures up to 205°C.        |
| <b>Microwave safe plastic containers</b> | YES. Use for reheating and defrosting. Some microwave-safe plastics are not suitable for cooking foods with high fat and sugar content. Follow manufacturer's directions. | NO  | NO  |
| <b>Plastic, thermoset®</b>               | YES   | YES. Are heat resistant up to 218°C. Do not use for broiling. | YES                                       |
| <b>Plastic wrap</b>                      | YES. Use brands specially marked for microwave use. DO NOT allow plastic wrap to touch food. Vent so steam can escape.  | NO  | NO  |
| <b>Pottery, porcelain stoneware</b>      | YES. Check manufacturer's recommendation for being microwave safe.  | YES   | YES. Must be microwave safe AND ovenable. |
| <b>Styrofoam</b>                         | YES. For reheating.   | NO  | NO  |
| <b>Wax paper</b>                         | YES. Good covering for cooking and reheating.   | NO  | NO  |
| <b>Wicker, wood, straw</b>               | YES. May be used for short periods of time. Do not use with high fat or high sugar content foods. Could char.   | NO  | NO  |



# INTRODUCTION

---

Congratulations on your new purchase. Your Fisher & Paykel oven has a number of features to make cooking a great experience for you:

- a wide choice of oven functions
- intuitive controls and displays

## Before you start

- Make sure the installer has completed the 'Final checklist' in the Installation instructions.
- Read this guide, taking special note of the 'Safety and warnings' section.
- Remove all packaging and dispose of it responsibly. Make sure all cable ties used to secure the shelves during shipping have been removed. Recycle items that you can.

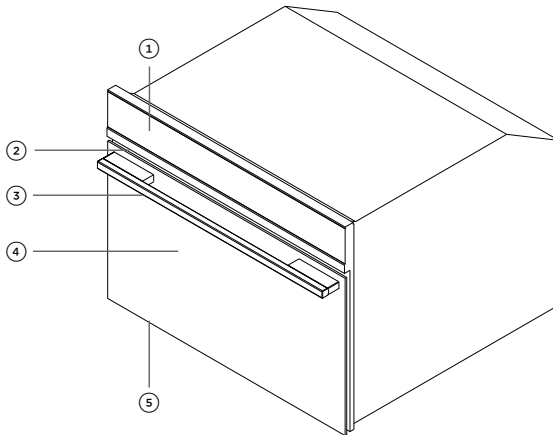

- ① Control panel
- ② Oven vent louvres
- ③ Oven door and handle
- ④ Oven light (not illustrated)
- ⑤ Oven seal (not illustrated)

# FIRST USE

---

## First use

- The oven should be thoroughly cleaned with soap and water and carefully rinsed.
- It is important that you condition the oven before using it for cooking and baking. Conditioning will burn off any manufacturing residue and ensure you get the best results from the start. There will be a distinctive smell and a small amount of smoke during conditioning. This is normal, but make sure the kitchen is well ventilated.
- Heat the oven for 30 minutes at the maximum temperature. Use the fan heat & grill function without accessories in the oven. Before using the accessories for the first time, clean them carefully with hot water, dishwashing liquid and a soft cloth.

## Assembling and disassembling the flat grill

To remove the flat grill, pull it towards you until it stops and then lift, by pulling upwards, until it comes completely out. To put the flat grill back in, insert it at a 45° angle and then position it horizontally and push it all the way in to the end of the grill track.



Grill and baking pan assembly

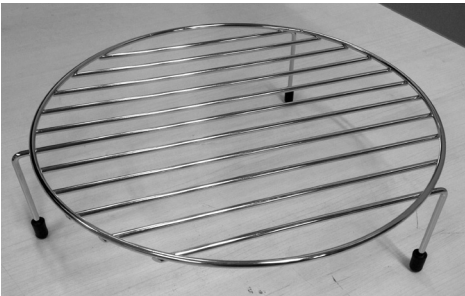

Grill oven rack

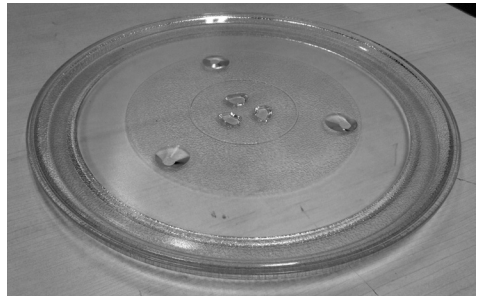

Glass turntable

If the flat grill has a drip tray, to remove it, lift it slightly and pull it towards you.

# FIRST USE

---

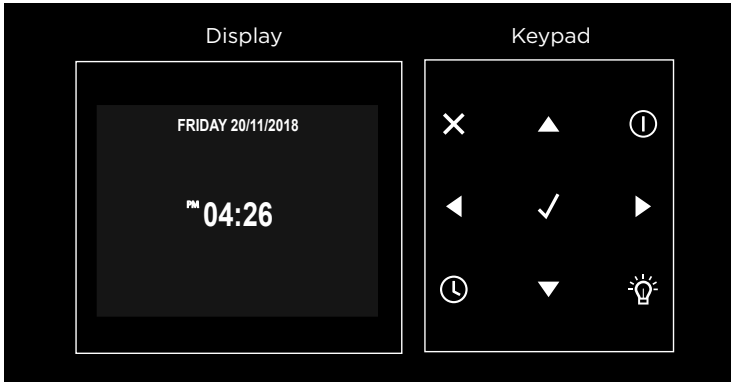

## Keypad

To operate the keypad, press gently. The keypad will not work if more than one key is pressed at the same time.



Movement arrows



Cancel and return to previous display page.  
Keep pressed to return to Home screen.



Switches the oven on and off.



Confirms the settings and starts cooking operations.  
When pressed during a cooking operation, the function is placed in pause. Press again to restart.



To set the timer.  
Enter the functions menu during cooking.



Switches the inner oven light on and off.

## **Error codes**

Error codes appear when a fault has been detected. When the error appears, the current function is blocked. If the type of error is related to a safety function, the oven becomes unusable and you will need to contact Customer Care. If the error relates to a minor fault, after being restarted the oven can be used for the functions that do not involve the faulty part (eg a heating element).

## **Beeps**

- Confirm that the command has been received after a key has been pressed.
- It also indicates that a time function has been completed (eg Timer or Automatic Cooking).
- When using the recipe function a beep will indicate that the oven is waiting for operation by the user (eg insert a dish).
- Beeps will also signal that there is an oven fault.

## **Default temperature**

The cooking modes automatically select a suitable temperature when the cooking mode is selected, the temperature can be modified at any time.

## **F Failure number codes**









Failure codes appear when the error code is recorded in the Error Log in the Setup menu. This error can be communicated to the service technician so they can understand the possible cause of the problem in advance.

## Timer

### **IMPORTANT!**

**The timer on your oven does not turn the appliance on or off. If you want to turn the oven off automatically, please refer to the automatic cooking section in use the end-of-cooking or delayed cooking function.**

NOTE: pressing the  button does not reset or stop the timer.

- ① Press  and set the desired time using the arrows   and confirm by pressing .
- To switch the selection between hours and minutes press the arrows  .
- ② The timer can be set from 1 minute to 12 hours and 59 minutes. When set, the remaining time is always visible in the status bar until the time expires or is reset.
- ③ To change or cancel the time set, you must reset the timer by pressing and holding  for a few seconds.
- ④ The timer format is usually HR:MIN, and switches to MIN:SEC during the last minute.
- ⑤ When the time expires, the display shows 00:00 and an alert will sound for one minute or until  is pressed.

## Preheat

When preheating, the current temperature is displayed together with the thermometer icon .

When the set temperature is reached, the control sounds an 'end of preheat' beep and the current temperature value disappears from the display.

## High altitude baking

When cooking at high altitude, recipes and cooking time will vary from the standard.

## Dishware

- Use microwave safe dishware.
- When using the oven in microwave mode, the dish must be placed on the rotating plate.
- When using the oven in combination mode, it is preferable to place the dish to be cooked on the round grill, supported so that it is centred on the rotating plate.

### Unsuitable dishware

### **IMPORTANT!**

**The flat grill must be removed when using the microwave and combined modes. Use it only with traditional oven functions.**

### Testing dishware

Never turn on the microwave oven before you have put in the food. The only exception allowed is testing dishware.

# FIRST USE

---

## **First use and user settings**

When using your oven for the first time, you will be prompted to enter user settings for:

- Time
- Date
- Language
- Temperature and weight measurements

NOTE: at the first connection and subsequent re-connections to the power supply, the door lock mechanism performs a calibration cycle in this phase, always keep the door closed.

These settings can be modified at anytime by accessing the settings menu.

## USER PREFERENCE SETTINGS

From the home screen press ◀ ▶ to select ⚙️. Then press ✓.  
To access the settings menu, no active cooking or any set time functions must be in progress.

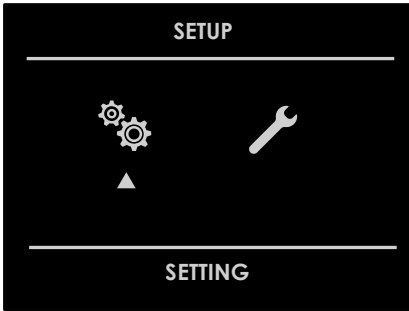

- ① Press ◀ ▶ to select the ⚙️ and confirm by pressing ✓.

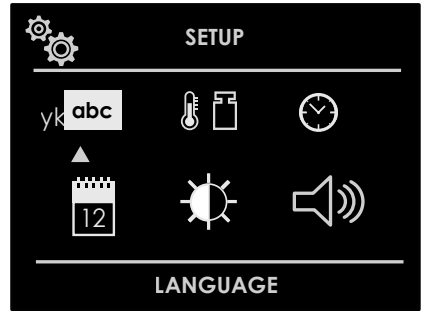

- ② In the set-up menu press ◀ ▶ or ▲ ▼ to select the setting you want to change, then press ✓.



### Language

Press ▲ ▼ to choose from available language options, make your selection by pressing ✓.



### Temperature and weight

Press ◀ ▶ and ▲ ▼ choose from available temperature and weight options, make your selection by pressing ✓.

## USER PREFERENCE SETTINGS

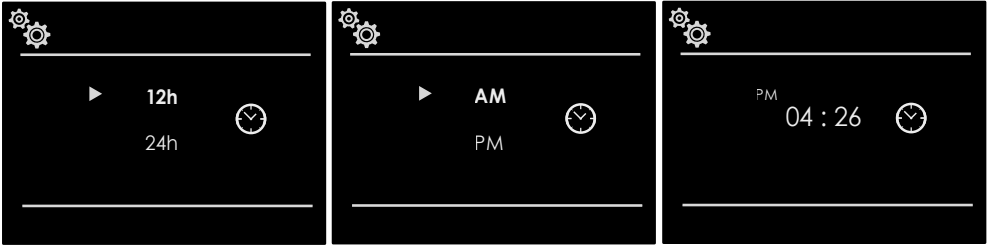

### Time

Press ▲▼ to choose from the available time settings, make your selection by pressing ✓. Then, set the time by pressing the up and down scroll arrows ▲▼ and press ✓ to confirm.

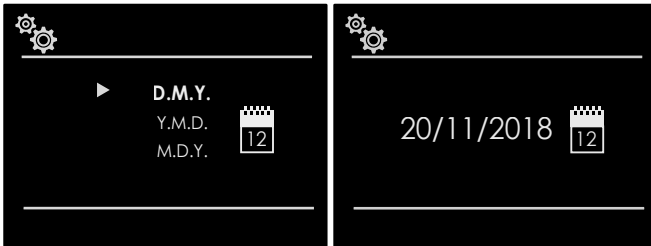

### Date

Press ▲▼ to choose from the available date options:

- Day.Month.Year
- Year.Month.Date
- Month.Date.Year

Confirm by pressing ✓.

Subsequently set the date by pressing ▲▼ and confirm by pressing ✓ key.

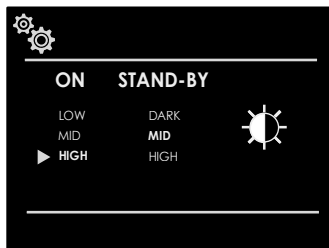

### Brightness

- ① Press ▲▼ to choose a brightness setting when the oven is in operation. Confirm your selection by pressing ✓.
- ② Then press ▲▼ arrows to choose a brightness setting when the oven is in stand-by mode. Confirm your selection by pressing ✓.



# USER PREFERENCE SETTINGS

---



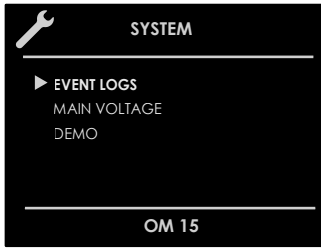
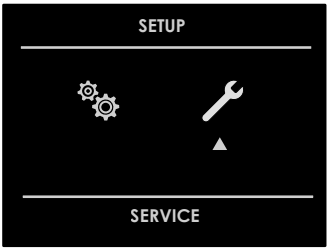

## Volume

Press ▲ ▼ to select the volume level and press ✓ to confirm your selection.



## System setup

The system menu allows you to access event logs – which displays errors and voltage information. Select  and confirm by pressing ✓.

- ① Press ◀ ▶ to select  and confirm by pressing ✓.
- ② Press ▲ ▼ choose from the available options. Press ✓ to confirm your selection.

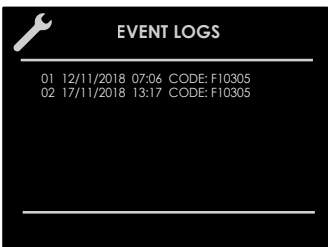

## Event log









The Event Log displays any recorded errors or faults. These codes can be communicated to Customer Support in the event of an error or fault.

# STARTING YOUR OVEN

## Switching the oven on and off





- Press ① to switch the oven on and press again to switch it off. The oven returns to standby mode.
- After switching off the oven, the cooling fan may continue to operate until the oven has cooled down.



## Selecting the cooking mode



| TRADITIONAL COOKING  | MICROWAVE COOKING  |
|--|--|
|  <b>FAN HEAT<br/>(FAN FORCED)</b>                         |  <b>DEFROST BY TIME</b>   |
|  <b>FAN HEAT &amp; GRILL<br/>(FAN FORCED &amp; GRILL)</b> |  <b>DEFROST BY WEIGHT</b>   |
|  <b>TURBO GRILL &amp; BASE HEAT<br/>(FAN GRILL)</b>       |  <b>MICROWAVE COOKING</b>   |
|  <b>ECO GRILL</b>   |  <b>MICROWAVE AND GRILL</b>                                       |
|  |  <b>MICROWAVE &amp; FAN HEAT<br/>(MICROWAVE &amp; FAN FORCED)</b> |

- ① Select the  and press ✓. Select the appropriate cooking mode by pressing ◀ ▶ and confirm by pressing ✓.
- ② If the temperature is correct, press ✓ to start cooking.  
To change the temperature use the up and down scroll arrows ▲ ▼ ◀ ▶ and confirm your selection by pressing ✓.  
If ✓ is not pressed within 10 seconds, the oven will begin cooking automatically on the settings that are currently selected.  
The temperature can also be adjusted during cooking.
- ③ To cancel a cooking mode during cooking press ✓ and then press ✕.

## COOKING MODE TABLES

| TRADITIONAL COOKING MODE                 | ICON  | TEMPERATURE |        |       |
|--|---|-------------|--------|-------|
|  |   | MIN.        | PRESET | MAX.  |
| FAN HEAT<br>(FAN FORCED)                 |  | 50°C        | 165°C  | 230°C |
| FAN HEAT & GRILL<br>(FAN FORCED & GRILL) |  | 50°C        | 210°C  | 230°C |
| TURBO GRILL & BASE HEAT<br>(FAN GRILL)   |  | 50°C        | 165°C  | 230°C |
| BROIL                                    |  | 50°C        | 230°C  | 230°C |

| MICROWAVE COOKING MODE | ICON  | SET       | WEIGHT |        |       | WATT   |
|------------------------|---|-----------|--------|--------|-------|--------|
|                        |   |           | MIN.   | PRESET | MAX.  | PRESET |
| DEFROST BY TIME        |  |           | -      | -      | -     | 150W   |
| DEFROST BY WEIGHT      |  | Bread     | 100g   | 500g   | 600g  | 150W   |
|                        |   | Vegetable | 100g   | 500g   | 1000g | 150W   |
|                        |   | Meat      | 100g   | 500g   | 1500g | 150W   |
|                        |   | Fish      | 100g   | 500g   | 800g  | 150W   |

| MICROWAVE COOKING MODE                           | ICON  | WATT |        |      | TEMPERATURE |        |       |
|--|---|------|--------|------|-------------|--------|-------|
|  |   | MIN. | PRESET | MAX. | MIN.        | PRESET | MAX.  |
| MICROWAVE COOKING                                |  | 150W | 900W   | 900W | -           | -      | -     |
| MICROWAVE AND GRILL                              |  | 150W | 300W   | 450W | -           | 200°C  | -     |
| MICROWAVE & FAN HEAT<br>(MICROWAVE & FAN FORCED) |  | 150W | 300    | 450W | 50°C        | 100°C  | 200°C |

# TRADITIONAL COOKING

## Changing the cooking mode

- ① Cooking can be paused by pressing **✓**.  
Cooking can be restarted by pressing **✓** again.
- ② To change the mode while cooking, press **✓** key and then **✕**.  
Another cooking mode can then be selected from the available options by pressing **◀ ▶**.

## Changing temperature

- ① From the cooking mode screen, the temperature can be changed by pressing **▲ ▼** and confirming your selection by pressing **✓**.
- ② During cooking the temperature can be changed, by pressing **▲ ▼**.

## Pre-heating

When the oven is preheating the actual temperature is displayed underneath the cooking mode icon.

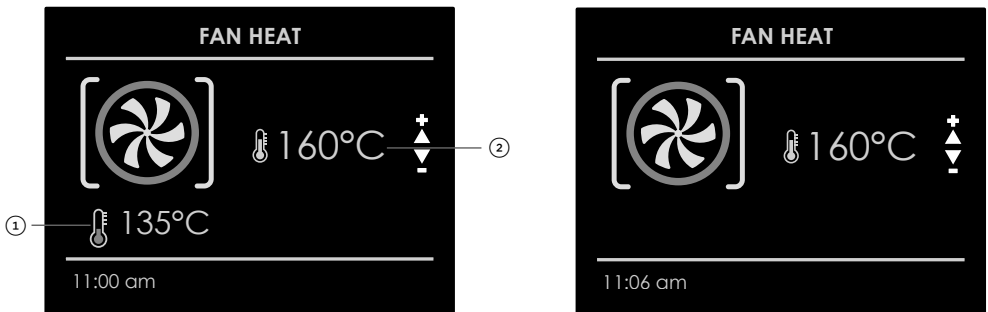

- ① Actual temperature
- ② Set temperature

When the set temperature is reached, a beep will confirm that the oven is preheated. The 'actual temperature' will disappear from the display.

NOTE: selecting a higher temperature does not shorten the preheat time.  
The preheating function is recommended to achieve the best results when cooking meat or baking cakes, biscuits, pastries and breads.

# AUTOMATIC COOKING



To use automatic cooking modes ensure that the clock is displaying the correct time.

NOTE: the time functions cannot be used if the meat probe is on. The maximum cooking time that can be set is 12 hours.

## Automatic cooking

Use the 'Cook time' function to operate the oven for a set period of time. The oven starts immediately and switches off automatically once the time has expired.

### To set a timed mode

- ① Select the cooking mode and temperature.
- ② There are two ways to set the function:
  - Select  to set the total cooking time and press ✓.
  - Select  to set the the time you would like cooking to end and press ✓.
- ③ After selecting one of the two above options, set the time by pressing ▲ ▼ and confirm pressing ✓.

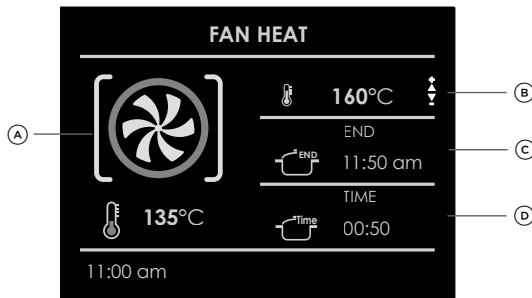

- ④ Cooking starts and the automatic cooking information is shown on the display:
  - Ⓐ Cooking mode
  - Ⓑ Set temperature
  - Ⓒ Cooking end time
  - Ⓓ Total cooking time
- ⑤ A series of beeps will indicate when the end time has been reached and the oven will automatically switch off.

# AUTOMATIC COOKING

## Time oven mode operation

To change the set cooking time when the oven is operating, press **⌚** and enter a new cooking time, then press **✓**.

## Setting start and end times

- ① Set the total cooking time as indicated in the 'Automatic cooking' section.
- ② Select **⌚<sup>END</sup>** to set the end time and press **✓**.
- ③ Change the cooking end time by pressing **▲▼** and confirm your selection by pressing **✓**.

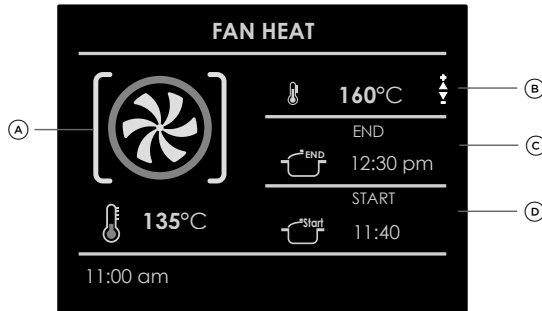

- ④ Based on the times provided for total cook time and end time, the oven will calculate the correct start time. The oven will turn on and off automatically.
  - A Cooking mode
  - B Set temperature
  - C Cooking end time
  - D Cooking start time

NOTE: the maximum cooking time that can be set is 12 hours.

- ⑤ A series of beeps will indicate when the end time has been reached and the oven will automatically switch off.

To change the cooking time and end time during cooking, press **⌚<sup>Time</sup>** or **⌚<sup>END</sup>** and change the time by pressing **◀ ▶**. Confirm your selection by pressing **✓**.

To cancel this function during cooking press **✓** and then press **X**.

## MICROWAVE COOKING

Microwave cooking modes can be paused and re-started again by pressing ✓.

Cooking modes can be accessed from the home screen, same as convection.

Instructions are on page 20.

When the function has been started, a countdown will be shown on the display.

The time can be changed by pressing ▲▼.

A message indicating that the function has been completed will appear on the display.

### Defrost by time

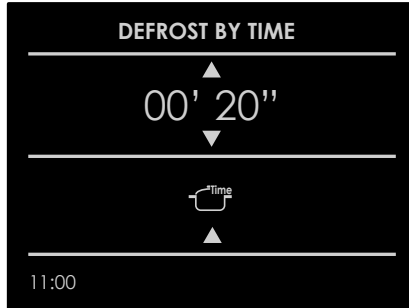

- ① Use the scroll arrows ◀ ▶ to select the . Confirm your selection by pressing ✓.
- ② Set the defrost time by pressing ▲▼. Start defrosting by pressing ✓.



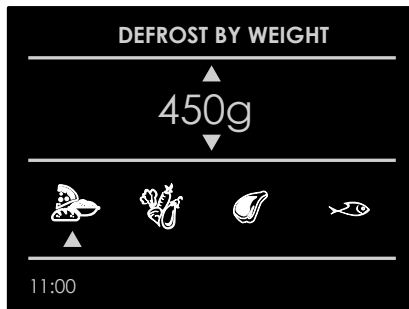

### Defrost by weight



- ① Press ◀ ▶ to select the . Confirm your selection by pressing ✓.
- ② Select the type of food by pressing ◀ ▶, then set the weight by pressing ▲▼. Start defrosting by pressing ✓.

## MICROWAVE COOKING

This table indicates the types of food and weights that can be set:

| FOOD  | WEIGHT |       |
|---|--------|-------|
|   | MIN.   | MAX.  |
|  BREAD, PIZZA, PASTA | 100g   | 600g  |
|  VEGETABLES          | 100g   | 1000g |
|  MEAT                | 100g   | 1500g |
|  SEAFOOD             | 100g   | 800g  |

The defrost time is calculated automatically and is set based on the type of food and weight that has been selected.

### Microwave function

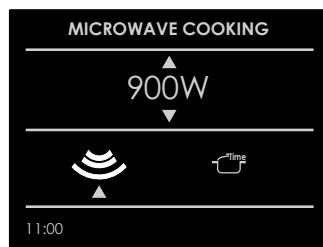
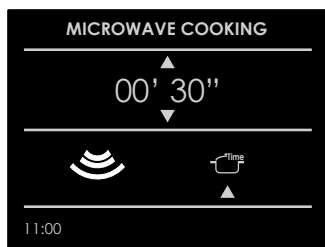

Select the Microwave function by pressing ◀ ▶ press ✓ to confirm your selection.

- If you wish to start the function immediately with a preset time of 30 seconds and a preset power of 900W, press the ✓.

To change the cooking time, press the arrows ◀ ▶ and select . Press ▲ ▼ to change the time.

To change the power, press the arrows ◀ ▶ and select . Press ▲ ▼ to change the power.

The six power level options are: 150W, 300W, 450W, 600W, 700W and 900W.







- Once the new parameters have been set, press ✓ to start cooking.
- Once cooking has started, a countdown will be shown on the display. The time can be changed at any time using the arrows ▲ ▼.
- At the end of cooking, the message 'END COOKING' will appear on the display.

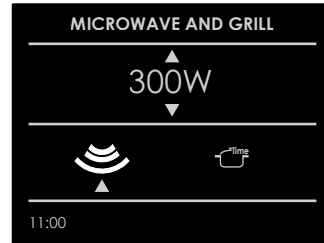
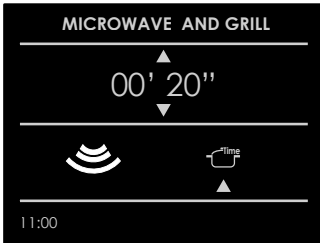

## MICROWAVE COOKING









### Microwave & grill function



Select the Microwave and Grill function  by pressing   and press  to confirm your selection. Set the cooking time by pressing  .

To start the function with the preset time of 20 seconds and a preset output of 300W, press .

If you wish to personalise the output, open the sub-menu managed as follows:

- To change the microwave power, press the arrows   and select . Press   to change the power. The three power level options are 150W, 300W and 450W.
- Press  to start cooking.
- When the function has started, a countdown will be shown on the display. The time can be changed by pressing  .
- When the countdown has been completed the message 'END COOKING' will appear on the display.

## MICROWAVE COOKING



### Microwave & fan heat function (microwave & fan forced)

Select the Microwave and Fan Heat function by pressing ◀ ▶ and press ✓ to confirm your selection. Set the cooking time by pressing ✓ ▲▼.

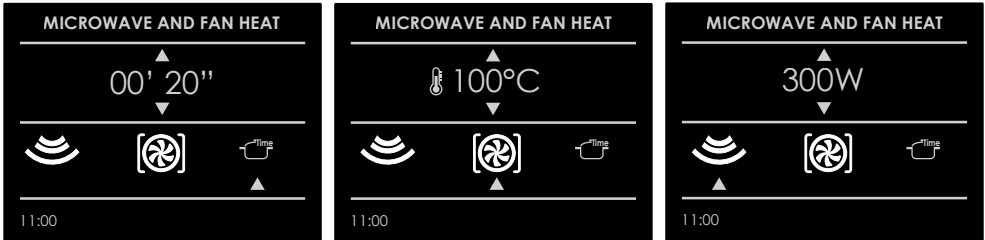
To start the function with the preset time of 20 seconds, a preset temperature of 100°C and a preset microwave output of 300W, press ✓.





If you wish to personalise the temperature and output, open the sub-menu managed as follows:





- To change the temperature, press the arrows ◀ ▶ and select . Press ▲▼ to change the temperature.
- To change the microwave power, press the arrows ◀ ▶ and select . Press ▲▼ to change the power.
- Press ✓ to confirm these changes and start cooking.

When the function has started, a countdown will be shown on the display. The time can be changed by pressing ▲▼.

When the countdown has been completed, the message 'END COOKING' will appear on the display.





## Changing Watts power

Press  then press .



Select  and change the power by pressing   and confirm your selection by pressing .





## Changing time

Press  then press .

Select  and change the countdown value by pressing   and confirm your selection by pressing .

## Changing temperature





Press  then press .

Select  and change the temperature by pressing   and confirm your selection by pressing .

Only available when using the microwave and ring function.

## Changing weight

(only available for defrost by weight)

Press  then change the weight by pressing   and confirm your selection by pressing .

Only available when using the defrost by weight function.





## Using oven lights

- Press  to turn lights on or off.
- The oven lights will turn on automatically when the door is opened.
- When a cooking mode has started, the oven lights will turn on automatically.
- When a cooking mode is finished or cancelled the lights will turn off.







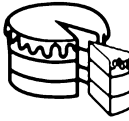









NOTE: when using oven mode the lights will automatically turn off after three minutes. To turn the lights back on, press  or open the door.

## RECIPES

The Recipe function on your oven enables you to cook without having to set the oven manually every time. By selecting a recipe, the cooking mode, temperature and time are automatically set according to the recipe selected from the menu.

| RECIPE LIST        | TYPE OF FOOD  | FOOD CONDITION | RECIPES LIST         | INFORMATION DISPLAYED     |
|--------------------|---|----------------|----------------------|---------------------------|
| PRESET or PERSONAL |    | FRESH          | BREAD PIZZA<br>FIRST |                           |
|                    |   | FROZEN         |                      |                           |
|                    |    | WHOLE          | MEAT                 | TYPE OF ACCESSORY         |
|                    |   | IN PIECES      |                      |                           |
|                    |    | WHOLE          | POULTRY              | LEVEL POSITION            |
|                    |   | IN PIECES      |                      | FOOD WEIGHT               |
|                    |    | WHOLE          | FISH                 | COOKING TIME              |
|                    |   | IN PIECES      |                      |                           |
|                    |  | -              | VEGETABLES           | PREHEAT REQUIRED (YES/NO) |
|                    |   | -              |                      |                           |
|                    |  | -              | PIES                 |                           |
|                    |   | -              |                      |                           |









## Select a preset recipe

- ① Press  then press .
- ② Press   to choose from 'PRESET' or 'PERSONAL' and confirm your selection by pressing .
- ③ Choose the type of food to be cooked by pressing   and   confirm your selection by pressing .
- ④ Press   to choose from 'FRESH' or 'FROZEN' options or from 'WHOLE' or 'IN PIECES' confirm your selection by pressing .
- ⑤ Select a recipe by pressing   confirm your selection by pressing .
- ⑥ When the recipe is confirmed, the following display page appears on the screen.
- ⑦ To start the cooking, confirm by pressing . During a recipe, a number of tones will signify visual messages appearing on the display. Follow these instructions to complete cooking the recipe.
- ⑧ A series of beeps along with a message on the display will indicate that the recipe is completed and the oven will switch off.



## Saving a personalised recipe

When a recipe has been selected, the 'Time' and 'Weight' can be changed and the recipe can be saved among the 'PERSONAL' ones. This will allow you to quickly access your favourite recipes.

- ① When a recipe has been selected, press  and confirm your selection by pressing .
- ② Change the weight by pressing   and confirm your selection by pressing .
- ③ Change the cooking time by pressing   and confirm your selection by pressing .



# RECIPES

## Select an already-set recipe

- ④ By selecting 'SAVE' and confirming this selection by pressing ✓, the recipe will now be saved in the 'PERSONAL' list of recipes.

NOTE: if the time and weight is changed and not saved immediately at the end of the recipe, a message appears which asks whether you want to save it.

- ⑤ To start the recipe press ✓.



## Removing a personalised recipe

To remove a recipe from the list of personalised recipes:

- ① Select the recipe you want to remove. Then press ◀ the recipe.
- ② A message 'Do you want to remove the recipe' will appear on the display. Select 'Yes' and press ✓.



## TROUBLESHOOTING

---

### Cooking problems

If there is a problem, check the chart below to see if you can fix it.

If the problem cannot be fixed or persists, call your Authorised Repairer or Customer Care.

| <b>PROBLEM</b>   | <b>POSSIBLE CAUSE</b>   |
|--|---|
| <b>Food browns unevenly</b>                                  | <ul style="list-style-type: none"><li>- Oven is not preheated</li><li>- Aluminum foil on oven rack or oven bottom</li><li>- Baking pan is too large for recipe</li><li>- Baking pans are touching each other or oven walls</li></ul>  |
| <b>Food too brown on bottom</b>                              | <ul style="list-style-type: none"><li>- Oven is not preheated</li><li>- Using glass, dull or darkened metal pans</li><li>- Incorrect rack position</li><li>- Baking pans are touching each other or oven walls</li></ul>  |
| <b>Food is dry or has shrunk excessively</b>                 | <ul style="list-style-type: none"><li>- Oven temperature too low</li><li>- Oven not preheated</li><li>- Oven door opened frequently during cooking</li></ul>  |
| <b>Food is baking or roasting too slowly</b>                 | <ul style="list-style-type: none"><li>- Food is tightly sealed with aluminum foil</li><li>- Pan size too small</li></ul>  |
| <b>Pie crusts do not brown on bottom or have soggy crust</b> | <ul style="list-style-type: none"><li>- Baking time is not long enough</li><li>- Using shiny steel pans</li><li>- Rack position is incorrect</li><li>- Oven temperature is too low</li></ul>  |
| <b>Cakes pale, flat and may not be done inside</b>           | <ul style="list-style-type: none"><li>- Oven is temperature too low</li><li>- Baking time is not long enough</li><li>- The cake has been tested too soon</li><li>- The oven door has been opened too often during baking</li><li>- Baking pan size may be too large</li></ul> |
| <b>Cakes high in middle with crack on top</b>                | <ul style="list-style-type: none"><li>- Baking temperature is too high</li><li>- Baking time is too long</li><li>- Baking pans are touching each other or oven walls</li><li>- Rack position is incorrect</li><li>- Baking pan size may be too small</li></ul>                |
| <b>Pie crust edges too brown</b>                             | <ul style="list-style-type: none"><li>- Oven temperature too high</li><li>- Edges of crust is too thin</li></ul>  |

## TROUBLESHOOTING

| <b>OVEN PROBLEM</b>  | <b>PROBLEM SOLVING STEPS</b>   |
|--|--|
| <b>Other F__ Error appears in the display window</b>                 | Remove power and turn it back on again after a few seconds. If condition persists, note the code number (in the EVENT LOG list) and contact Customer Support or your authorised repairer.                    |
| <b>The oven display won't turn on</b>                                | Turn off power at the main power supply, then turn the power back on.<br>If this does not resolve the issue, call Customer Support or an authorised repairer.  |
| <b>The cooling fan continues to run after the oven is turned off</b> | The fan will turn off automatically when the electronic components have cooled sufficiently.   |
| <b>Oven is not heating</b>   | Check the circuit breaker or fuse box to your house. Check that power is being supplied to the oven. Make sure the oven temperature has been selected.   |
| <b>Oven is not cooking evenly</b>                                    | Refer to cooking charts for recommended rack position.<br>Always reduce recipe temperature by 15°C when baking with Fan Heat mode.   |
| <b>Oven light is not working properly</b>                            | Check that power is being supplied to the oven. Refer to the clock section of this userguide. If the oven light has failed, the bulb must be replaced by an authorised Fisher and Paykel service technician. |
| <b>Clock and timer are not working properly</b>                      | Make sure there is proper electrical power to the oven.  |
| <b>Excessive moisture</b>  | Using the convection mode will eliminate any moisture in the oven.   |
| <b>Turning off demo mode</b>   | To disable the function, press the arrows ◀ ▶ to enter the DEMO display page and select off. Confirm your selection by pressing ✓.   |



## WARRANTY AND SERVICE

---

### **Before you call for service or assistance...**

Check the things you can do yourself. Refer to the installation instructions and your user guide and check that:

- ① Your product is correctly installed.
- ② You are familiar with its normal operation.

If after checking these points you still need assistance or parts, please refer to the Service & Warranty book for warranty details and your nearest Authorised Service Centre, Customer Care, or contact us through our website [fisherpaykel.com](http://fisherpaykel.com).

Complete and keep for safe reference:

Model \_\_\_\_\_  
Serial No. \_\_\_\_\_  
Purchase Date \_\_\_\_\_  
Purchaser \_\_\_\_\_  
Dealer \_\_\_\_\_  
Suburb \_\_\_\_\_  
Town \_\_\_\_\_  
Country \_\_\_\_\_





**FISHERPAYKEL.COM**

© Fisher & Paykel Appliances 2019. All rights reserved.

The product specifications in this booklet apply to the specific products and models described at the date of issue. Under our policy of continuous product improvement, these specifications may change at any time. You should therefore check with your Dealer to ensure this booklet correctly describes the product currently available.

**591590D 11.20**