

Series 11, Professional Tall Double DishDrawer Dishwasher

Professional



Boasting bold Professional styling including a stainless steel interior, each drawer operates independently, for flexible washing

- Eight wash cycles from Heavy to Light, including Auto, 60min and Glassware
- Tall top drawer fits full-size dinner plates up to 12 1/4 inches, with flexible racking for large cookware
- Wi-Fi capability and a SmartHQ™ app for remote control and notifications

DIMENSIONS

Height	34 - 36 3/8 "
Width	23 9/16 "
Depth	22 9/16 "

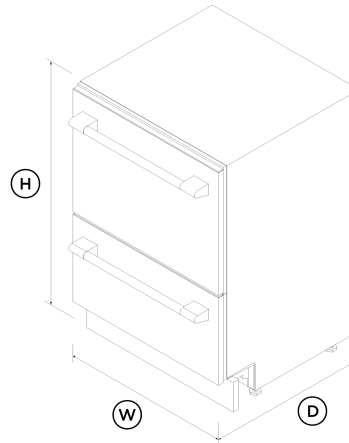

FEATURES & BENEFITS

Ease Of Use

DishDrawer™ Dishwashers are beautiful to use with soft-close drawers. The tall top drawer fits your larger plates and dishes up to 12 1/4 inches, while the bottom drawer is ideal for small washes. Flexible racking includes height-adjustable cup racks and wine glass supports.

Design Quality

Every detail has been carefully crafted using quality materials, from the easy-to-clean stainless steel interior to the spray arm sensor that detects jams for increased wash confidence.

Complementary Design

With distinctive, bold styling, this DishDrawer™ Dishwasher is designed to match the Fisher & Paykel Professional style family of appliances.

True Half Load

Both drawers fit a true half load. Each drawer operates independently, so you can wash one load while stacking the other drawer, or wash simultaneously on separate cycles.

Flexible Wash Options

Eight wash programs including Auto, 60min and Glassware, while modifiers such as Sanitize, Dry+ and Quiet provide added wash flexibility. The Quiet wash modifier reduces the noise on some cycles while maintaining performance - perfect for late night washing.

Efficient performance

With a Energy Star Most Efficient rating, this DishDrawer™ Dishwasher is recognised amongst the most energy efficient models on the market.

SPECIFICATIONS

Accessories (included)

- Cutlery basket
- Kickstrip **true**
- Knife clip and multipurpose clip

Capacity and loading

- Accommodates round plates up to (lower drawer) **11"**
- Accommodates round plates up to (upper drawer) **12.25"**
- Adjustable height, foldable cupracks

Fold down tines	•
Pitch adjustable tines	•
Place settings	14
Place settings	14
Place settings per drawer	7
Wine glass supports with stemware grippers	•

Connected Features

Alerts and notifications	•
Education and onboarding	•
Monitoring	•
Software updates	•

Consumption

Energy rating	Energy star Most efficient
Energy usage	225kWh/year
In-use energy carbon emissions estimate	79.4kgCO2e/year
Water usage (per wash cycle)	3.1 gal running both tubs

Controls

Electronic fault/Diagnostic indicator	•
End of cycle beeps	•
Energy saving delay start option of up to 12 hours	•
Internal wash selector	•
Keylock	•
Rinse aid indicator light	•
Smart appliance	•

Spray arm sensing	•
-------------------	---

Features

Fan assisted drying	•
Flow through detergent dispenser	•
Internal tub material	Stainless steel
Motor type	BLDC
Quiet operation	•
SmartDrive™ technology	•
Soft close drawer	•

Performance

Noise on standard cycle top drawer	44 dBA
------------------------------------	---------------

Power Requirements

Amperage	10A
Electric circuit	3
Rated current	15 A
Supply frequency	60Hz
Supply voltage	100 - 120V

Product Dimensions

Depth	22 9/16 "
Height	34 - 36 3/8 "
Width	23 9/16 "

Wash Program Modifiers

Dry +	•
Quiet	•
Sanitise	•
Wash modifiers	3

Wash Programs

60 min	•
Auto	•
Eco	•
Glassware	•
Heavy	•
Light	•
Medium	•
Rinse	•
Wash programs	8

Water connection

Inlet water temperature	140 °F
Supplied hose to suit 3/8" (9mm) male compression fitting	•
Water pressure	30kPa - 1000 kPa
Water supply	3/8" to suit Male Compression Fitting

SKU	82397
-----	--------------

The product dimensions and specifications in this page apply to the specific product and model. Under our policy of continuous improvement, these dimensions and specifications may change at any time. You should therefore check with Fisher & Paykel's Customer Care Centre to ensure this page correctly describes the model currently available. © Fisher & Paykel Appliances Ltd 2020

Our In-use Energy Carbon Emissions Estimate is designed to assist customers in making informed purchasing decisions when comparing different Fisher & Paykel products. For example, a heat pump dryer typically has a lower In-use Energy Carbon Emissions Estimate than a vented dryer.



A PEACE OF MIND SALE
24 Hours 7 Days a Week Customer Support

T 1.888.936.7872 W www.fisherpaykel.com

Other product downloads available at fisherpaykel.com

- [↓ Archicad](#)
- [↓ Data Sheet \(English\)](#)
- [↓ Energy Label](#)
- [↓ Installation Guide \(English\)](#)
- [↓ Installation Guide \(Canadian French\)](#)
- [↓ Installation Guide \(Spanish\)](#)
- [↓ California Warning Proposition 65 \(English, Spanish, Canadian French, Chinese\)](#)
- [↓ Revit](#)
- [↓ Rhino](#)
- [↓ Right To Repair Declaration \(English, Canadian French\)](#)
- [↓ SketchUp](#)
- [↓ User Guide \(English\)](#)
- [↓ User Guide \(Canadian French\)](#)
- [↓ Wash Program Data \(English\)](#)

Where applicable:

All appliances use energy, and energy usage typically generates carbon emissions. **Fisher & Paykel Appliances' In-use Energy Carbon Emissions Estimate** indicates carbon emissions from a product's in-use energy. This is calculated either annually or per cycle, using the product's market-specific energy label energy consumption data multiplied by the carbon emissions factor for energy in your country or region.