

60cm Series 9 Minimal Built-in Coffee Maker

Minimal



Indulge in barista-style coffee at home. From Latte to Macchiato, you can enjoy perfectly crafted coffee just the way you prefer.

- With 13 options from Americano to Macchiato, for barista-standard coffee at home
- Your favourite coffee can be memorised to start your desired time, for automatic brewing
- With self-cleaning function for an effortless clean
- Part of our suite of companion products, designed to match for flexible configurations

DIMENSIONS

Height	458 mm
Width	596 mm
Depth	484 mm

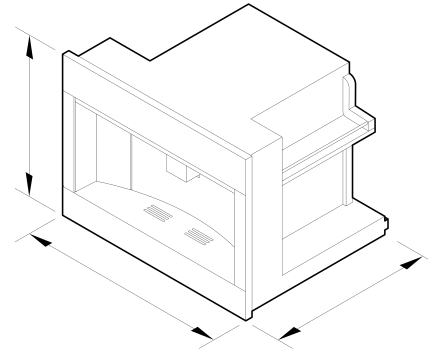

FEATURES & BENEFITS

Coffee Choice

Our coffee maker has 13 different options to suit individual taste and selection - from Flat White to Latte to Macchiato.

Self-Cleaning

The coffee maker has a self-cleaning function, and comes with a removable drip tray and a waste container for used coffee grounds.

Complementary Design

Designed to match our Minimal style Companion suite, this Coffee Maker has a sleek black glass finish.

Coffee Your Way

With a programmable timer your favourite coffee can be memorised and set to start at the same time each day. The intuitive touch display includes refill, cleaning and maintenance data, while twin LED lights illuminate your beverages creating a welcoming glow on those dark mornings.

Sized To Suit

Perfect for the compact kitchen, this Built-in Coffee Maker can be placed virtually anywhere. All our companion products can be installed at a convenient height to suit your kitchen design and preference.

Barista-Style Coffee

The conical burr grinder delivers a consistent grind for the perfect coffee. Set it to suit your preference.

SPECIFICATIONS

Accessories (included)

Coffee spoon	•
Descaling agent bottle	•
Extractable steam outlet	•
Thermal milk jug (Auto Cappuccino)	0.5 L
Water filter	•

Capacity

Coffee bean container capacity	350 g
Drip tray capacity	0.8 L
Grounds container capacity	14 cups of coffee
Number of cups	1 or 2
Water tank capacity	2.4 L

Cleaning

- Easy to remove coffee grinds container •
- Easy to remove stainless steel hot water/ steam pipe •
- Removable drip tray with level indicator •
- Self-clean function •

- Latte macchiato •
- Long black •
- Number of functions **13**
- Personalised coffee •
- Steam •
- Takes pre ground coffee •

Width **596 mm**

SKU **82467**

The product dimensions and specifications in this page apply to the specific product and model. Under our policy of continuous improvement, these dimensions and specifications may change at any time. You should therefore check with Fisher & Paykel's Customer Care Centre to ensure this page correctly describes the model currently available. © Fisher & Paykel Appliances Ltd 2020

Controls

- Cleaning reminder •
- Coffee grounds full reminder •
- High resolution touch display •
- Intuitive information display •
- LED lights **4**
- Multi-language interface **true**
- Refill coffee bean reminder •
- Water tank empty indicator •

Performance

- Coffee temperatures **5 x setting**
- Grinder **Stainless steel conical burr**
- Grinding coarseness **13 positions**
- Heating system **Thermablock with stainless steel tube & steamer**
- Heating system power (coffee / steam) **1200 W**
- Integrated cup warmer shelf •
- Integrated storage for accessories •
- Pump power **50**
- Pump pressure **15 Bar**

Other product downloads available at fisherpaykel.com

- [↓ DXF](#)
- [↓ Archicad](#)
- [↓ DWG](#)
- [↓ Installation Guide \(English\)](#)
- [↓ Planning Guide - 60cm Minimal Ovens and Companions \(English\)](#)
- [↓ Planning Guide - Handleless Ovens and Companions \(English\)](#)
- [↓ Revit](#)
- [↓ Revit](#)
- [↓ Rhino](#)
- [↓ SketchUp](#)
- [↓ User Guide \(English\)](#)

Functions

- Americano •
- Cappuccino •
- Coffee •
- Coffee strength levels **5**
- Cup size levels **4 + manual**
- Double espresso •
- Espresso •
- Espresso macchiato •
- Flat white •
- Hot milk •
- Hot water •
- Latte •

Power requirements

- Amperage **10 A**
- Supply frequency **50 Hz**
- Supply voltage **240 V**

Where applicable:

Product dimensions

- Depth **484 mm**
- Height **458 mm**

All appliances use energy, and energy usage typically generates carbon emissions. **Fisher & Paykel Appliances' In-use Energy Carbon Emissions Estimate** indicates carbon emissions from a product's in-use energy. This is calculated either annually or per cycle, using the product's market-specific energy label energy consumption data multiplied by the carbon emissions factor for energy in your country or region.

Our In-use Energy Carbon Emissions Estimate is designed to assist customers in making informed purchasing decisions when comparing different Fisher & Paykel products. For example, a heat pump dryer typically has a lower In-use Energy Carbon Emissions Estimate than a vented dryer.



A PEACE OF MIND SALE
24 Hours 7 Days a Week Customer Support
T 1300 650 590 W www.fisherpaykel.com