

Wall Rangehood, 90cm, Box Chimney

Series 7 | Contemporary

Black Stainless Steel and Glass



This Contemporary style rangehood extracts steam, grease and cooking odours quietly and efficiently.

- With three fan speeds plus boost, select the perfect extraction rate for your cooking
- Powerful maximum air movement of 780m³/hr
- Energy-efficient LED lighting to illuminate your cooking surface
- Wi-Fi enabled for notifications through the SmartHQ™ app

DIMENSIONS

Height	635-1035mm
Width	898mm
Depth	500mm

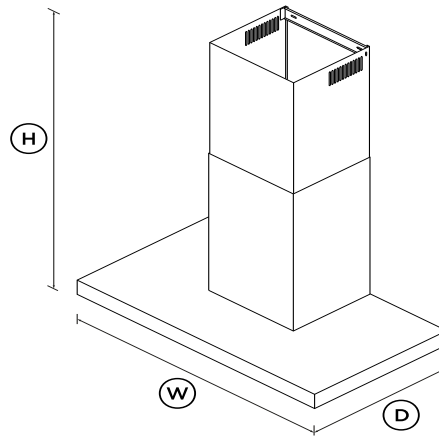

FEATURES & BENEFITS

Effective Extraction

Featuring perimeter extraction, four fan speeds, and a boost function, this range hood provides powerful extraction to quickly remove odors and steam. Odours can linger in the kitchen well after cooking is finished so the timer keeps the hood working for up to 15 minutes before automatically turning off.

Simple Controls

The intuitive control panel responds to the touch of your finger. LED strip lighting illuminates the entire cooktop surface for the perfect sear or ideal reduction. Rangehood settings, including temperature and fan speed, can be controlled via the SmartHQ™

app, with additional voice control options for fan speeds and lighting.

Easy cleaning

Designed for simple removal, the filters are easy to clean and dishwasher safe, while the glass and stainless steel finish is easily wiped clean. The SmartHQ™ app will notify you when to clean the filter to ensure you get the best performance out of your rangehood.

Complementary Design

The brushed black stainless steel finish of this vent hood will complement any contemporary kitchen and is designed to match the rest of Fisher & Paykel kitchen appliance family.

Easy installation

This rangehood is the perfect partner to your Fisher & Paykel cooktop. It can be either externally ducted or internally recirculated, making it perfect for apartments.

Designed To Match

With the option of stainless steel or brushed black stainless steel, you can choose the perfect finish to match your Fisher & Paykel cooktop and achieve a coherent kitchen aesthetic.

SPECIFICATIONS

Accessories

Aluminium filter	793707
------------------	--------

Accessories (sold separately)

Chimney extension	793716
Recirculation carbon filter	793599
Recirculation diverter	793713

Fan ratings

Maximum air movement	810m ³ /hr
----------------------	-----------------------

Installation and cleaning

Dishwasher safe filters	3
Ducted	Top extraction only
Recirculation	Optional - top extraction
Stainless steel filter cover	•
Two piece height adjustable	•

Performance

Extraction type	Surface
Fan speeds	3
Filter type	Mesh
Number of filters	3

Power requirements

Supply frequency	50Hz
Supply voltage	220-240V
Total Power	248W

Product dimensions

Depth	500mm
Height	635-1035mm
Width	898mm

Product information

Control type	Capacitive touch
--------------	-------------------------

Ventilation features

Auto-off/Run-on timer	•
Dimmable lights	•

Filter cleaning alert	•
Light type	LED strip
Timer function	•
Wi-Fi connectivity	•

Warranty

Parts and labour	2 years
------------------	----------------

SKU	50195
-----	-------

The product dimensions and specifications in this page apply to the specific product and model. Under our policy of continuous improvement, these dimensions and specifications may change at any time. You should therefore check with Fisher & Paykel's Customer Care Centre to ensure this page correctly describes the model currently available. Fisher & Paykel Appliances Ltd 2020

Where applicable:

All appliances use energy, and energy usage typically generates carbon emissions. **Fisher & Paykel Appliances' In-use Energy Carbon Emissions Estimate** indicates carbon emissions from a product's in-use energy. This is calculated either annually or per cycle, using the product's market-specific energy label energy consumption data multiplied by the carbon emissions factor for energy in your country or region.

Our In-use Energy Carbon Emissions Estimate is designed to assist customers in making informed purchasing decisions when comparing different Fisher & Paykel products. For example, a heat pump dryer typically has a lower In-use Energy Carbon Emissions Estimate than a vented dryer.

Other product downloads available at fisherpaykel.com

- [Service & Warranty](#)
- [User Guide Wall Rangehood](#)
- [Installation Guide Wall Rangehood](#)
- [Preliminary Specification Guide Wall Rangehood](#)
- [Data Sheet Rangehood](#)



A PEACE OF MIND SALE

24 Hours 7 Days a Week Customer Support

T 0800 372 273 Wwww.fisherpaykel.com