

60cm Series 9 3 Burner Gas Cooktop, Natural Gas

Minimal



A powerful three-burner with precise control and performance. Designed to pair with other Minimal style kitchen appliances for a cohesive, considered kitchen.

- Three burners include a dual flame wok burner and two semi-rapid burners
- Minimal style with elegant black trim and black ceramic glass cook zones
- Flame-failure safety device automatically turns off the gas if the flame goes out
- Easy to clean with removable trivets and wipeable ceramic glass

DIMENSIONS

Height	124 mm
Width	600 mm
Depth	530 mm

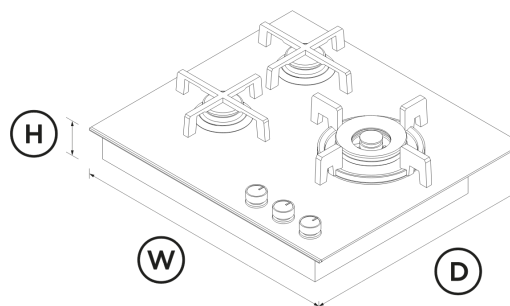

FEATURES & BENEFITS

Complementary Design

The subtle black glass, anodised trim, and black dials blend elegance with durability, designed to match our Minimal style Series 9 ovens. Featuring premium styling and detailing, this cooktop seamlessly integrates with other appliances, for a cohesive and considered kitchen design.

Precise Control

The dual flame wok burner ensures consistent flame and heat distribution, while the highly responsive dials allow for precise heat adjustment. This combination is perfect for achieving a slow simmer for sauces or an intense heat for searing steaks.

Easy Cleaning

Cleaning and care of these cooktops is easy with sealed burners and a single sheet cooking surface. After each use, simply remove the trivets and wipe down the glass.

Quality Materials

Featuring cast iron trivets, anodised metal dials, and high-temperature resistant ceramic glass, our cooktops are built with the finest materials for optimal performance.

Safe & Sound

The flame failure safety device automatically turns off the gas if the flame is accidentally extinguished.

Crafted For Durability

Our cooktops are built from recyclable, eco-friendly ceramic glass, avoiding the use of arsenic or heavy metals in the manufacturing process. The glass edges are chip-tested for resistance to damage from pots and pans, ensuring lasting quality.

SPECIFICATIONS

Accessories (included)

High power wok cooking	•
Small pan support	•
Wok stand	true

Accessories (sold separately)

Dial kit Professional, Stainless Steel	82223 Part 536498
--	----------------------

Burner ratings

Dual wok burner (inner only)	2.4MJ/h
Dual wok burner power	16.6MJ/h
Semi-rapid burner power	8.4MJ/h
Wok burner power	16.6MJ/h

Burners

Number of burners	3
-------------------	---

Cleaning

- Easy clean cooktop design
- Quick component removal

Controls

- Dual wok control
- Dual wok feature for simmering
- Ergonomic control dials
- Toughened fused glass graphics

Performance

- Both LPG & NG models available
- Cast iron trivets
- Electronic ignition
- Quick connect gas valves

Power requirements

Supply voltage **230 - 240 V**

Product dimensions

Depth **530 mm**
 Height **124 mm**
 Width **600 mm**

Safety

- Flame failure system

Zones

Number of zones **3**

SKU **81988**

The product dimensions and specifications in this page apply to the specific product and model. Under our policy of continuous improvement, these dimensions and specifications may change at any time. You should therefore check with Fisher & Paykel's Customer Care Centre to ensure this page correctly describes the model currently available. © Fisher & Paykel Appliances Ltd 2020

Other product downloads available at fisherpaykel.com

- ↓ DWG
- ↓ DXF
- ↓ Installation Guide (English)
- ↓ Revit

- ↓ Rhino
- ↓ SketchUp
- ↓ User Guide (English)

Where applicable:

All appliances use energy, and energy usage typically generates carbon emissions. **Fisher & Paykel Appliances' In-use Energy Carbon Emissions Estimate** indicates carbon emissions from a product's in-use energy. This is calculated either annually or per cycle, using the product's market-specific energy label energy consumption data multiplied by the carbon emissions factor for energy in your country or region.

Our In-use Energy Carbon Emissions Estimate is designed to assist customers in making informed purchasing decisions when comparing different Fisher & Paykel products. For example, a heat pump dryer typically has a lower In-use Energy Carbon Emissions Estimate than a vented dryer.



A PEACE OF MIND SALE
 24 Hours 7 Days a Week Customer Support
 T 0800 372 273 Wwww.fisherpaykel.com