

Top Loader Washing Machine, 8.5kg

Series 5 | Top Load

White



With room for large loads, this top loader runs on SmartDrive™ technology for a quieter, quicker wash.

- Six wash cycles including Allergy, Wool, Delicate and a 30 minute Quick cycle to cater to busy lives
- Includes extra wash feature Soak, for helping to clean tough stains
- Soft-close lid avoids slamming and allows for hands-free operation
- Fast 1000RPM spin speed to remove more water for quicker drying

DIMENSIONS

Height	1045 - 1075mm
Width	600mm
Depth	600mm

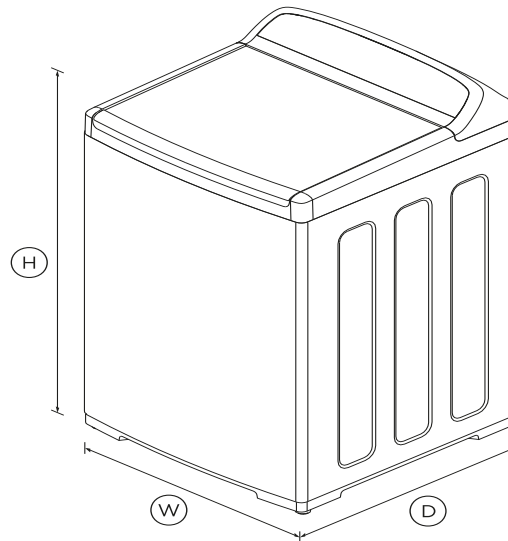

FEATURES & BENEFITS

Fast full load

Fast cycle times allow you to wash a full 8.5kg load in as little as 59 minutes.

Easy To Use

This machine has a cycle to suit every type of load including Delicate, Allergy and Wool. Select a cycle with easy-to-use SmartTouch™ controls.

Soft Close Lid

The robust lid has a soft close mechanism that makes it family safe, avoids slamming and allows for hands-free operation.

Cares for clothes

The flexible finned agitator ensures less tangling for superior clothes care.

SPECIFICATIONS

Consumption

Energy rating	2.5 star
Energy usage	568kWh/year
In-use energy carbon	370.0kgCO2e/year
Water consumption per cycle	96L
Water efficiency	3.5 star (WELS)

Features

Adjustable alert beeps	•
Agitator	Flexible finned
Auto out of balance correction	•
Automatic water level	•
Controlled cold	•
Delay start	•
Detergent dispenser	•
Eco rinse	•
Fabric softener dispenser	•
Lid lock	•
Manual water levels	5
No spin / Spin Hold	•
Rinse options	3
SmartTouch™ control dial	•

Soak	•
Spin speeds	3
Stainless steel drum	•
Water temperature controls	5

Performance

Auto-Lint disposal	•
Load sensing	•
Maximum spin speed	1000rpm
Number of spin speeds	3
SmartDrive™ technology	•

Product dimensions

Depth	600mm
Height	1045 - 1075mm
Height (Lid open)	1350 - 1380mm
Width	600mm

Warranty

Parts and labour	2 years
Parts only SmartDrive™ Motor	10 years

Wash Cycles

Allergy	•
Delicate	•
Heavy	•
Number of wash cycles	6
Quick	•
Regular	•
Wool	•

SKU 92263

The product dimensions and specifications in this page apply to the specific product and model. Under our policy of continuous improvement, these dimensions and specifications may change at any time. You should therefore check with Fisher & Paykel's Customer Care Centre to ensure this page correctly describes the model currently available. Fisher & Paykel Appliances Ltd 2020

Where applicable:

All appliances use energy, and energy usage typically generates carbon emissions. **Fisher & Paykel Appliances' In-use Energy Carbon Emissions Estimate** indicates carbon emissions from a product's in-use energy. This is calculated either annually or per cycle, using the product's market-specific energy label energy consumption data multiplied by the carbon emissions factor for energy in your country or region.

Our In-use Energy Carbon Emissions Estimate is designed to assist customers in making informed purchasing decisions when comparing different Fisher & Paykel products. For example, a heat pump dryer typically has a lower In-use Energy Carbon Emissions Estimate than a vented dryer.

Other product downloads available at fisherpaykel.com

- [↓](#) User Guide
- [↓](#) Service & Warranty
- [↓](#) Energy & Water Label
- [↓](#) Installation Guide



A PEACE OF MIND SALE

24 Hours 7 Days a Week Customer Support

T 1300 650 590 Wwww.fisherpaykel.com