

FISHER & PAYKEL

STEAM OVEN



OS24N models

USER GUIDE

US CA

CONTENTS

Safety and warnings	2
Introduction	7
First use	8
User preference settings	13
Starting your oven	16
Cooking mode tables	17
Traditional cooking	18
Steam cooking	19
Using oven lights	22
Automatic cooking	23
Using the meat probe (some models only)	25
Recipes	28
Care and cleaning	31
Replacing the oven lamp	32
Troubleshooting	33
Warranty and service	35

IMPORTANT! **SAVE THESE INSTRUCTIONS**

The models shown in this user guide may not be available in all markets and are subject to change at any time. For current details about model and specification availability in your country, please go to our website fisherpaykel.com or contact your local Fisher & Paykel dealer.

SAFETY AND WARNINGS

WARNING!



ELECTRICAL SHOCK HAZARD

Before carrying out any work on the electrical section of the appliance, it must be disconnected from the mains electricity supply.

Connection to a good ground wiring system is absolutely essential and mandatory.

Alterations to the domestic wiring system must only be made by a qualified electrician.

Failure to follow this advice may result in electrical shock or death.

WARNING!



FIRE HAZARD

Do not use adapters, reducers, or branching devices to connect this appliance to the mains power supply.

Failure to follow this advice may result in overheating, burning, or fire.

WARNING!



CUT HAZARD

Take care - some edges are sharp.

Failure to use caution could result in injury or cuts.

IMPORTANT SAFETY INSTRUCTIONS!

Save these instructions for the local inspectors use.

To avoid hazard, follow these instructions carefully before installing or using this appliance.

- Make this information available to the person installing the appliance – doing so could reduce your installation costs.
- This oven is to be installed and connected to the electricity supply only by an authorized person.
- If the installation requires alterations to the domestic electrical system, call a qualified electrician. The electrician should also check that the socket cable section is suitable for the electricity drawn by the oven.
- The oven must be grounded.
- Installation must comply with your local building and electricity regulations.
- This appliance must be installed and connected to the mains power supply only by a suitably qualified person according to these installation instructions and in compliance with any applicable local building and electricity regulations. Failure to install the appliance correctly could invalidate any warranty or liability claims.
- If the power supply cable is damaged, it must be replaced by the manufacturer, its service agent or similarly qualified person in order to avoid a hazard.
- A circuit breaker is recommended.
- Do not use adaptors, reducers or branching devices to connect the oven to the mains electricity supply, as they can cause overheating and burning.
- Make sure the cavity is completely sealed with no gaps. This is to ensure the oven cooling system functions correctly.
- The appliance must be installed and used in an ambient temperature between 41°F and 95°F.

SAFETY AND WARNINGS

Operation

Your oven has been carefully designed to operate safely during normal cooking procedures. Keep the following safety instructions in mind when you are using it:

⚠ WARNING!



ELECTRICAL SHOCK HAZARD

Turn the oven off at the wall before replacing the oven lamp.
Failure to follow this advice may result in electrical shock or death.

⚠ WARNING!



FIRE HAZARD

Do not place aluminium foil, dishes, trays, water or ice on the oven floor during cooking, as doing so will irreversibly damage the enamel; lining the oven with aluminium foil may even cause fire.
Never use your appliance for warming or heating the room.
Persons could be burned or injured or a fire could start.
Storage in or on appliance: flammable materials should not be stored in an oven or near its surface.
Failure to follow this advice may result in overheating, burning, and injury.

⚠ WARNING!



HOT SURFACE HAZARD

Accessible parts may become hot when in use.
To avoid burns and scalds, keep children away.
Use oven mitts or other protection when handling hot surfaces such as oven shelves or dishes.
Use care when opening the oven door.
Let hot air or steam escape before removing or replacing food.
Do not touch heating elements or interior surfaces of the oven.
Heating elements may be hot even though they are dark in colour.
Interior surfaces of an oven become hot enough to cause burns.
During and after use, do not touch, or let clothing or other flammable materials contact heating elements or interior surfaces of the oven until they have had sufficient time to cool.
Other surfaces of the appliance may become hot enough to cause burns - among these surfaces are the oven vent, the surface near the oven vent, and the oven door.
Failure to follow this advice could result in burns and scalds.

⚠ WARNING!



CUT HAZARD

Take care - some edges are sharp.
Failure to use caution could result in injury or cuts.

IMPORTANT SAFETY INSTRUCTIONS!

To reduce the risk of fire, electrical shock, injury to persons or damage when using the oven, follow the important safety instructions listed below:

- Read all the instructions before using the oven. Use the oven only for its intended purpose as described in these instructions.
- **PROPER INSTALLATION:** be sure your appliance is properly installed and grounded by a qualified technician.
- **ISOLATING SWITCH:** make sure this oven is connected to a circuit which incorporates an isolating switch providing full disconnection from the power supply.
- Household appliances are not intended to be played with by children.
- Do not leave children alone. Children should not be left alone or unattended in the area where the appliance is in use. They should never be allowed to sit or stand on any part of the appliance.
- Children of less than 8 years old must be kept away from the appliance unless continuously supervised. This appliance can be used by children aged from 8 years and above, and persons with reduced physical, sensory or mental capabilities or lack of experience and knowledge, if they have been given supervision or instruction concerning the use of the appliance in a safe way and they understand the hazards involved. Cleaning and user maintenance shall not be done by children without supervision.
- Do not place heavy objects on the oven door.
- Do not let aluminium foils and meat probes touch the heating elements.
- Do not store flammable materials in or near the oven.
- Wear proper apparel. Do not wear loose fitting or hanging garments when using the appliance. They could ignite or melt if they touch an element or hot surface and you could be burned.
- In addition, avoid using acid or alkaline substances (such as lemon, vinegar, salt, tomatoes, etc.). Avoid using products containing chlorine, acids or abrasives, especially for cleaning painted parts.
- **USER SERVICING:** do not repair or replace any part of the appliance unless specifically recommended in the manual. All other servicing should be referred to a qualified technician.
- Do not use water on grease fires. Smother the fire or flame or use a dry chemical or foam type extinguisher.
- Use only dry oven mitts or potholders. Moist or damp potholders on hot surfaces could result in burns from steam. Do not let potholders touch hot areas or heating elements. Do not use a towel or a bulky cloth for a potholder. It could catch fire.
- Do not heat unopened food containers. They can build up pressure that may cause the container to burst and result in injury.
- **SAFE FOOD HANDLING:** leave food in the oven for as short a time as possible before and after cooking. This is to avoid contamination by organisms which may cause food poisoning. Take particular care during warm weather.
- Always keep oven vents unobstructed.
- Do not operate your appliance by means of an external timer or separate remote control system.

IMPORTANT SAFETY INSTRUCTIONS!

- **CAUTION:** Hot air can blow from the vent at the base of the oven as part of the oven's cooling system.
- **PLACEMENT OF OVEN SHELVES:** always position shelves in the desired location while the oven is cool (before preheating). If a shelf must be removed while the oven is hot, do not let the oven mitts or potholder contact hot heating elements in the oven or the base of the oven.
- Do not clean the oven seal or use any oven-cleaning products on it. It is essential for a good seal, which ensures that the oven operates efficiently. Care should be taken not to rub, damage or move it.
- Before cleaning the oven, always disconnect the plug from the outlet.
- Incorrect maintenance can cause corrosion of the steel cooking cavity.
- The oven must be cleaned periodically and all food residues must be removed.
- Do not clean the oven immediately after use as the residual steam will still be very hot.
- If there is a risk of frost, the residual water in the pumps could freeze and damage them.
- Do not use oven cleaners, harsh/abrasive cleaning agents, waxes, or polishes. No commercial oven cleaner, oven liner, or protective coating of any kind should be used in or around any part of the oven. Do not use harsh/abrasive cleaners, scourers or sharp metal scrapers to clean the oven door glass since they scratch the surface, which may result in the glass shattering.
- Clean only the parts listed in this manual.
- Do not spray water or use a steam cleaner to clean any part of the oven. Use only slightly damp rags.
- Do not store things children might want above the oven. Children could be burned or injured while climbing on the oven to retrieve items.
- Do not install or operate the appliance if it is damaged or not working properly. If you receive a damaged product, contact your dealer or installer immediately.
- Use only bakeware approved for oven use. Follow the bakeware manufacturer's instructions.
- The California Safe Drinking Water and Toxic Enforcement Act requires businesses to warn customers of potential exposure to substances which are known by the State of California to cause cancer or reproductive harm. Small amounts of harmful chemicals are given off in the oven's self-cleaning cycle from insulation and food decomposition. Significant exposure to these substances can cause cancer and reproductive harm. Venting with a hood or open window, and wiping out excess food spills prior to self cleaning the oven reduces exposure.

INTRODUCTION

Congratulations on your new purchase. Your Fisher & Paykel oven has a number of features to make cooking a great experience for you:

- A wide choice of oven functions.
- Intuitive controls and displays.

Before you start

- Make sure the installer has completed the 'Final checklist' in the Installation instructions.
- Read this guide, taking special note of the 'Safety and warnings' section.
- Remove all internal and external packaging and dispose of it responsibly. Recycle items that you can.
- The oven should be thoroughly cleaned with soap and water and carefully rinsed.
- It is important that you condition the oven before using it for cooking and baking. Conditioning will burn off any manufacturing residue and ensure you get the best results from the start. There will be a distinctive smell and a small amount of smoke during conditioning. This is normal, but make sure the kitchen is well ventilated.
- Heat the oven for 30 minutes at the maximum temperature. Use the True Convection function without accessories in the oven.
- Before using the accessories for the first time, clean them carefully with hot water, dishwashing liquid and a soft cloth.

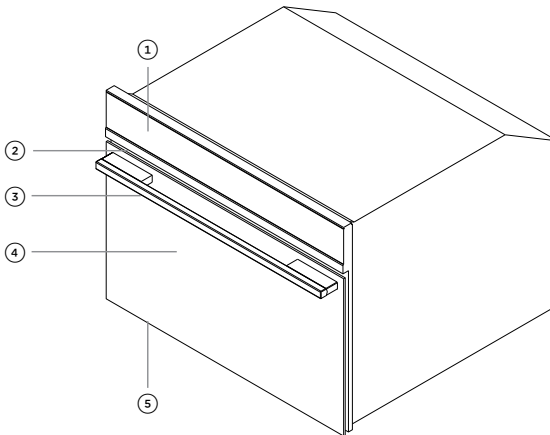

- ① Control panel
- ② Oven vent louvres
- ③ Oven door and handle
- ④ Oven light (not illustrated)
- ⑤ Oven seal (not illustrated)

FIRST USE

Using the wire shelf

- To remove the wire shelf, pull it towards you until it stops and then lift, by pulling upwards, until it comes completely out.
- To insert the wire shelf, slide it in at an angle of 45° until it locks and then lower it horizontally and push it all the way in.
- If the wire shelf has a low drip tray, to remove it, lift it slightly and slide it towards you.

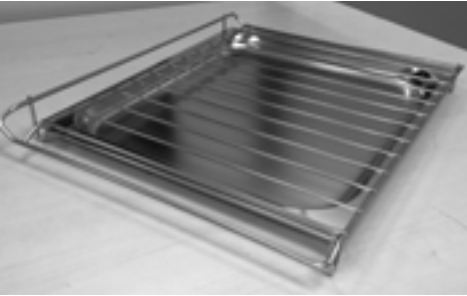

Wire shelf and baking pan

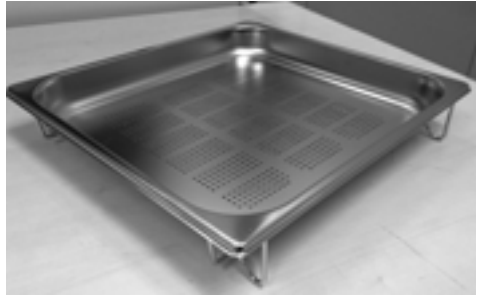

Perforated tray



Meat probe (some models only)

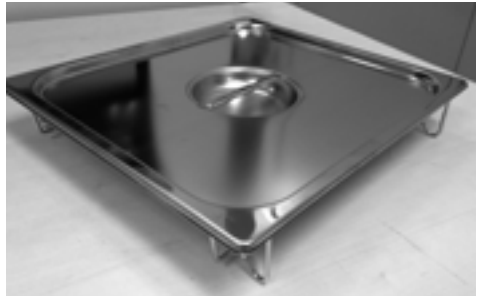



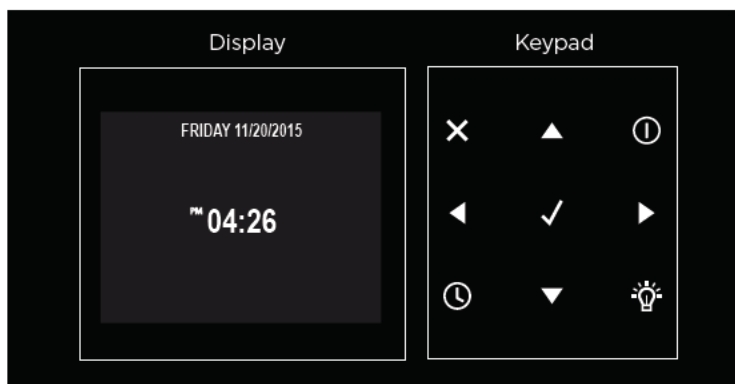





Perforated tray with lid



Keypad

To operate the keypad, press gently. The keypad will not work if more than one key is pressed at the same time.

-  Movement arrows
-  Movement arrows
-   Movement arrows
-  Cancel and return to previous display page.
Keep pressed to return to Home screen.
-  Switches the oven on and off.
-  Confirms the settings and starts cooking operations.
When pressed during a cooking operation, the function is placed in pause. Press again to restart.
-  To set the timer.
Enter the functions menu during cooking.
-  Switches the inner oven light on and off.

Error codes

Error codes appear when a fault has been detected. When the error appears, the current function is blocked. If the type of error is related to a safety function, the oven becomes unusable and you will need to contact Customer Care. If the error relates to a minor fault, after being restarted the oven can be used for the functions that do not involve the faulty part (eg a heating element).

Beeps

- Confirms that the command has been received after a key has been pressed.
- It also indicates that a time function has been completed (eg Timer or Automatic Cooking).
- When using the recipe function a beep will indicate that the oven is waiting for operation by the user (eg insert a dish).
- Beeps will also signal that there is an oven fault.

Default temperature

The cooking modes automatically select a suitable temperature when the cooking mode is selected, the temperature can be modified at any time.

F Failure number codes









Failure codes appear when the error code is recorded in the Error Log in the Setup menu. This error can be communicated to the service technician so they can understand the possible cause of the problem in advance.

Timer

IMPORTANT!

The timer on your oven does not turn the appliance on or off. If you want to turn the oven off automatically, please refer to the automatic cooking section to use the end-of-cooking or delayed cooking function.

NOTE: Pressing the  button does not reset or stop the timer.

- ① Press  and set the desired time using the arrows   and confirm by pressing . To switch the selection between hours and minutes use the arrows  .
- ② The timer can be set from 1 minute to 12 hours and 59 minutes. When set, the remaining time is always visible in the status bar until the time expires or is reset.
- ③ To change or cancel the time set, you must reset the timer by pressing and holding  for a few seconds.
- ④ The timer format is usually HR:MIN, and switches to MIN:SEC during the last minute.
- ⑤ When the time expires, the display shows 00:00 and an alert will sound for one minute or until  is pressed.

Preheat

- When preheating, the current temperature is displayed together with the thermometer icon.
- When the set temperature is reached, the control sounds an 'end of preheat' beep and the current temperature value disappears from the display.

High altitude baking

When cooking at high altitude, recipes and cooking time will vary from the standard.

FIRST USE

First use and user settings

When using your oven for the first time, you will be prompted to enter user settings for:

- Time
- Date
- Language
- Temperature and weight measurements

These settings can be modified at anytime by accessing the settings menu.

USER PREFERENCE SETTINGS

From the home screen press ◀ ▶ to select ⚙️. Then press ✓.
To access the settings menu, no active cooking or any set time functions must be in progress.

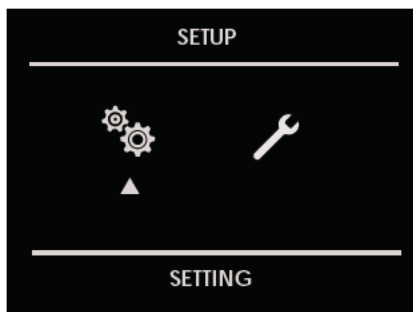

- ① Press ◀ ▶ to select the ⚙️ and confirm by pressing ✓.

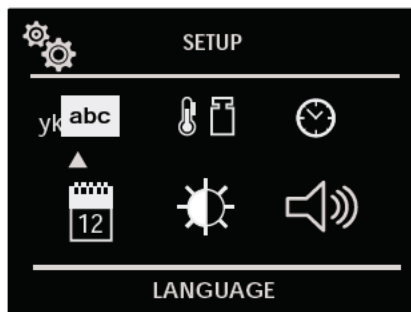

- ② In the set-up menu press ◀ ▶ or ▲ ▼ to select the setting you want to change, then press ✓.



Language

Press ▲ ▼ to choose from available language options, make your selection by pressing ✓.



Temperature and weight

Press ◀ ▶ and ▲ ▼ choose from available temperature and weight options, make your selection by pressing ✓.

USER PREFERENCE SETTINGS

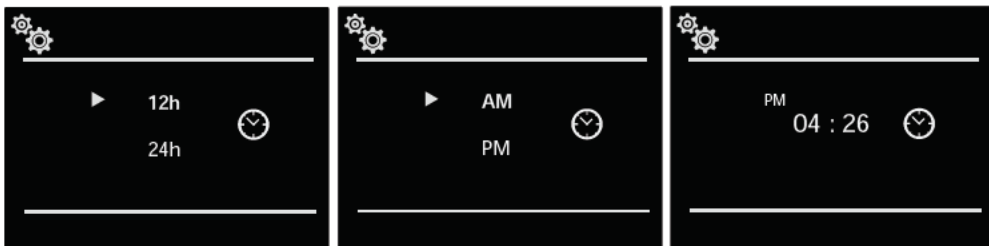

Time

Press ▲▼ to choose from the available time settings, make your selection by pressing ✓. Then, set the time by pressing the up and down scroll arrows ▲▼ and press ✓ to confirm.

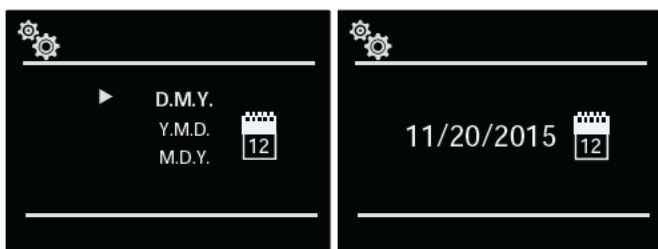

Date

Press ▲▼ to choose from the available date options:

- Day.Month.Year
- Year.Month.Date
- Month.Date.Year

Confirm by pressing ✓.

Subsequently set the date by pressing ▲▼ and confirm by pressing ✓ key.

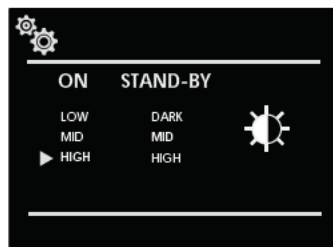

Brightness

- ① Press ▲▼ to choose a brightness setting when the oven is in operation. Confirm your selection by pressing ✓.
- ② Then press ▲▼ arrows to choose a brightness setting when the oven is in stand-by mode. Confirm your selection by pressing ✓.



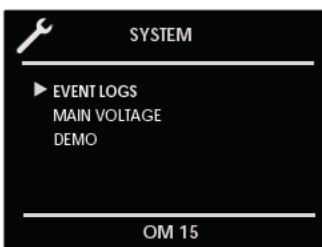
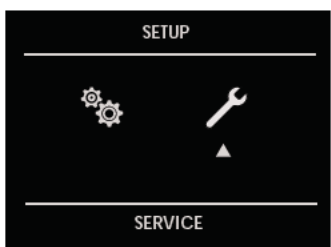

Volume

Press ▲ ▼ to select the volume level and press ✓ to confirm your selection.



System setup

The system menu allows you to access event logs - which displays errors and voltage information. Select  and confirm by pressing ✓.

- ① Press ◀ ▶ to select  and confirm by pressing ✓.
- ② Press ▲ ▼ choose from the available options. Press ✓ to confirm your selection.

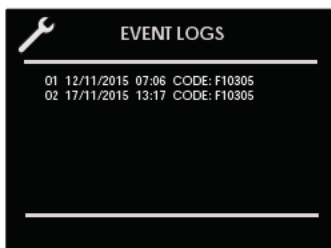

Event log

The Event Log displays any recorded errors or faults. These codes can be communicated to Customer Support in the event of an error or fault.

STARTING YOUR OVEN

Switching the oven on and off

- Press ① to switch the oven on and press again to switch it off. The oven returns to standby mode.
- After switching off the oven, the cooling fan may continue to operate until the oven has cooled down.

Selecting the cooking mode

TRADITIONAL COOKING



TRUE CONVECTION
(TRUE AERO)



RING & GRILL



CONVECTION BROIL
(CONVECTION AERO)



BROIL



ECO BAKING

STEAM COOKING



STEAM 100



STEAM 130



STEAM & RING

CLEANING











CLEAN STEAM OVEN





CLEAN STEAM CIRCUIT

- ① Select  and press ✓. Select the appropriate cooking mode by pressing ◀ ▶ and ▲ ▼ confirm by pressing ✓.
- ② If the proposed temperature is correct, press ✓ to start cooking, if ✓ is not pressed within 10 seconds, the oven will begin cooking automatically on the settings that are currently selected. The temperature can also be adjusted during cooking.
- ③ To cancel a cooking mode during cooking press ✓ and then press ✕.

COOKING MODE TABLES

COOKING MODE	ICON	TEMPERATURE		
		MIN.	PRESET	MAX.
TRUE CONVECTION (TRUE AERO)		120°F 50°C	330°F 165°C	445°F 230°C
RING & GRILL		120°F 50°C	410°F 210°C	445°F 230°C
CONVECTION BROIL (CONVECTION AERO)		120°F 50°C	330°F 165°C	445°F 230°C
BROIL		120°F 50°C	445°F 230°C	445°F 230°C
ECO BAKING		120°F 50°C	330°F 165°C	445°F 230°C
STEAM 100		105°F 40°C	210°F 100°C	210°F 100°C
STEAM 130		160°F 70°C	265°F 130°C	265°F 130°C
STEAM & RING		120°F 50°C	330°F 165°C	445°F 230°C

CLEAN MODE	ICON	TEMPERATURE		
		MIN.	PRESET	MAX.
CLEAN STEAM OVEN		-	210°F 100°C	-
CLEAN STEAM CIRCUIT		-	-	-

TRADITIONAL COOKING

Changing the cooking mode

- ① Cooking can be paused by pressing **✓**.
Cooking can be restarted by pressing **✓** again.
- ② To change the mode while cooking, press **✓** key and then **✕**.
Another cooking mode can then be selected from the available options by pressing **◀ ▶**.

Changing temperature

- ① From the cooking mode screen, the temperature can be changed by pressing **▲ ▼** and confirming your selection by pressing **✓**.
- ② During cooking the temperature can be changed, by pressing **▲ ▼**.

Pre-heating

When the oven is preheating the actual temperature is displayed underneath the cooking mode icon.

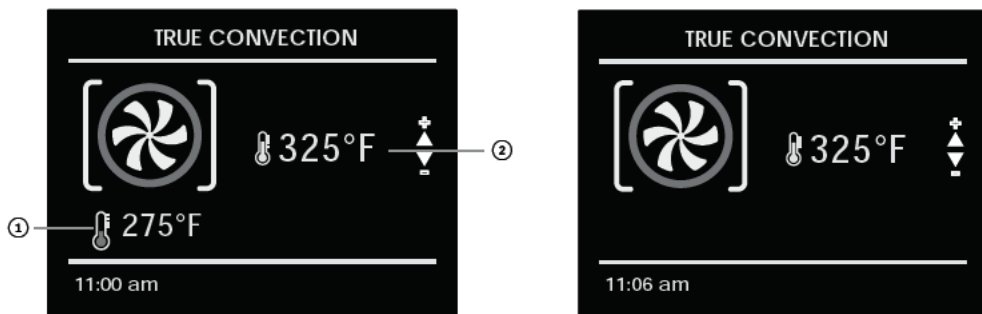

- ① Actual temperature
- ② Set temperature

When the set temperature is reached, a beep will confirm that the oven is preheated. The 'actual temperature' will disappear from the display.

NOTE: selecting a higher temperature does not shorten the preheat time.
The preheating function is recommended to achieve the best results when cooking meat or baking cakes, biscuits, pastries and breads.

STEAM COOKING

Steam cooking has numerous benefits which include retaining the nutritional value of food, along with retaining taste, structure, color and natural juices.

Useful tips

- To ensure that you get the best results from using the steam function, start cooking food from a cold oven. Avoid using the steam cooking function directly after using the convection oven, as this will reduce the benefits of steam cooking.
- We recommend using the perforated stainless steel tray together with the baking pan, to get the best results when using the steam function. This allows food to be fully cooked while collecting juice from the food in the tray.

NOTE: the steam functions will not start until the door is closed.

- To start steam cooking select the required steam functions from the available options by pressing ◀ ▶. Confirm your selection by pressing ✓.
- The steam cooking function can be pused at any time by pressing ✓. When pressed again ✓ the function restarts.

When done cooking, the support of the perforated tray can be used as a support to keep the hot tray off of the counter while you remove the food you just cooked.



Steam cooking

IMPORTANT

Before using any steam functions, the water container must be filled. If while the oven is on, the message CHECK WATER CONTAINER appears on the display, open the door and avoid hot steam that will be released, extract the container and refill it. When the door is closed, the oven will go into PAUSE mode. Press ✓ to continue cooking.

Steam 100

This function allows you to cook on three different rack levels at the same time. We recommend placing meat on the upper and middle racks and vegetables on the middle and lower racks.

NOTE: Use oven safe dishes and trays when using the steam functions. Remove any lids and ensure food is positioned above the grill.

Steam 130

This mode allows you to modify the temperature while steam cooking. This type of function is particularly suitable for heating pre-cooked food and for preparing ready, semi-ready meals and frozen foods from 160°F (72°C) to 265°F (130°C).

IMPORTANT!

Once the functions have been completed, a circuit discharge request will be sent (see WATER DISCHARGE paragraph).

STEAM COOKING

Steam & ring

- After starting the oven, food is initially steamed. Depending on the size and amount of food being cooked, the oven will automatically move into a convection cooking phase.
- This function is particularly suited to cooking large meat and seafood dishes as well as baking bread and pastries. The recommended cooking temperature for baking bread and pastries using this function is from 370°F (180°C) to 410°F (210°C).





NOTE: if you're using this function to cook consecutive meals, ensure that the oven has cooled before starting to cook the following meal.

Steam assist function



- This particular function can only be used with convection oven functions. By adding steam to the oven cavity it will ensure that food remains tender and does not dry out. This function is ideal for cooking roasts, seafood or large meat dishes.
- Once the oven has been turned on, the steam assist function will only become available once the internal oven temperature has exceeded 210°F (100°C). At this stage  will appear on the display.

NOTE: this function is not enabled during steam cooking.

To inject steam inside the cavity, press  then select  using   and confirm your selection by pressing .

- The steam assist function will continue for five minutes, and will then return to the previously set cooking function.

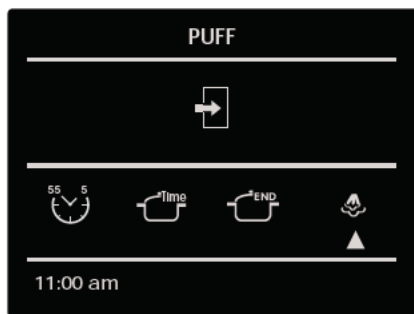

USING OVEN LIGHTS

- Press  to turn lights on or off.
- The oven lights will turn on automatically when the door is opened.
- When a cooking mode has started, the oven lights will turn on automatically.
- When a cooking mode is finished or cancelled the lights will turn off.

NOTE: when using oven mode the lights will automatically turn off after three minutes. To turn the lights back on, press  or open the door.

AUTOMATIC COOKING







To use automatic cooking modes ensure that the clock is displaying the correct time.

NOTE: The time functions cannot be used if the meat probe is on. The maximum cooking time that can be set is 12 hours.

Automatic cooking

Use the 'Cook time' function to operate the oven for a set period of time. The oven starts immediately and switches off automatically once the time has expired.

To set a timed mode

- ① Select the cooking mode and temperature.
- ② There are two ways to set the function:
 - Select  to set the total cooking time and press .
 - Select  to set the time you would like cooking to end and press .
- ③ After selecting one of the two above options, set the time by pressing   and confirm pressing .



- ④ Cooking starts and the automatic cooking information is shown on the display:
 - Ⓐ Cooking mode
 - Ⓑ Temperature
 - Ⓒ End of cooking time
 - Ⓓ Total cooking time
- ⑤ A series of beeps will indicate when the end time has been reached and the oven will automatically switch off.

AUTOMATIC COOKING

To change the set cooking time when the oven is operating, press **ⓐ** and enter a new cooking time, then press **✓**.

Setting start and end times

- ① Set the total cooking time as indicated in the 'Automatic cooking' section.
- ② Select **END** to set the end time and press **✓**.
- ③ Change the cooking end time by pressing **▲ ▼** and confirm your selection by pressing **✓**.



- ④ Based on the times provided for total cook time and end time, the oven will calculate the correct start time. The oven will turn on and off automatically.
 - A Cooking mode
 - B Temperature
 - C Cooking end time
 - D Cooking start time

NOTE: The maximum cooking time that can be set is 12 hours.

- ⑤ A series of beeps will indicate when the end time has been reached and the oven will automatically switch off.

To change the cooking time and end time during cooking, press **Time** or **END** and change the time by pressing **◀ ▶**. Confirm your selection by pressing **✓**.

To cancel this function during cooking press **✓** and then press **X**.

USING THE MEAT PROBE (SOME MODELS ONLY)

Setting the temperature for meat probe

The meat probe is supplied with some models only. For other models it may be purchased separately. For further information or to purchase a meat probe, contact Customer Care, your authorized service centre or visit our website: fisherpaykel.com.

Use your meat probe to accurately judge when meat is perfectly cooked. The meat probe will gauge the core temperature of the meat and will stop cooking when the selected temperature has been reached.

IMPORTANT

Only use the meat probe that has been supplied for this oven.

FOOD		MINIMUM INTERNAL TEMPERATURE	
MINCE			
Hamburger		165°F	74°C
Beef, veal, lamb, pork		165°F	74°C
Chicken, turkey		165°F	74°C
BEEF, VEAL, LAMB			
Roasts and steaks:	Rare	125°F	51°C
	Medium-rare	135°F	57°C
	Medium	145°F	63°C
	Well done	160°F	71°C
PORK			
Chops, roasts, ribs:	Medium	160°F	71°C
	Well done	171°F	77°C
Fresh sausages		165°F	74°C
POULTRY			
Whole chicken or chicken pieces		171°F	77°C
Duck		171°F	77°C
Turkey breast		171°F	77°C

USING THE MEAT PROBE (SOME MODELS ONLY)

IMPORTANT!

- **To avoid burns, use a kitchen glove to fit and remove the meat probe when the oven is hot.**
 - **Always remove the probe using the grip. Removing it by pulling the cable, may cause damage.**
 - **Make sure food is completely defrosted before using the probe.**
 - The meat probe is not enabled for all functions, for example the meat probe function cannot be used when using the recipe function.
 - If the meat probe is fitted during a function it is not enabled for, a removal message will appear on the display.
 - If the meat probe is accidentally removed during operation, a warning message appears on the display.
 - The temperature of the probe can be set between 104°F (40°C) and 212°F (100°C).
 - The oven stores the last temperature set by the user.
-
- The probe socket is located in the upper left corner of the oven cavity, protected by a metal cover.
 - Prior to turning the oven on, remove the cover and insert the probe connection all the way in.
 - The probe should click into place.

NOTE: the probe will not work if it is connected when the oven is already turned on.



Keep the metal cover in a safe place when using the meat probe, as this will need to be re-inserted for use in other cooking modes.



USING THE MEAT PROBE (SOME MODELS ONLY)

Insert the tip of the probe into the center of the thickest part of the fully defrosted meat. The thicker the meat, the longer it will take to cook, so it is important that the probe is measuring the temperature of the meat at its thickest point.

Make sure the probe does not touch bone, fat or gristle, as these will heat up more quickly than the lean meat.

The meat probe icon will appear on the display .

When a cooking mode is selected with the probe inserted, a display page will appear where you can select the settings for the meat probe.

- ① Select the cooking mode and then press **▲▼** to set the oven temperature and press **✓** to confirm.
- ② Set the required probe temperature by pressing **▲▼** and confirm your selection by pressing **✓**.

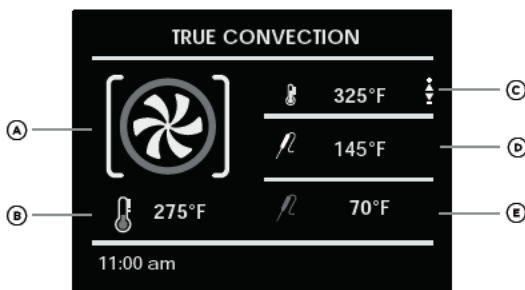

- ③ Cooking will start and all probe cooking details appear on the screen.
 - A Cooking mode
 - B Actual temperature
 - C Set temperature
 - D Set probe temperature
 - E Current probe temperature

Once the set probe temperature is reached, the oven switches off and a tone indicates that cooking is completed.







NOTE: After cooking has started, the oven temperature can be changed at any time by pressing **▲▼**.

To change the probe temperature, press **✓** and then press **X**.

















Change the temperature by pressing **▲▼** and confirm your selection by pressing **✓**.

RECIPES

The Recipe function on your oven enables you to cook without having to set the oven manually every time. By selecting a recipe, the cooking mode, temperature and time are automatically set according to the recipe selected from the menu.

RECIPE LIST	TYPE OF FOOD	FOOD CONDITION	RECIPES LIST	INFORMATION DISPLAYED
PRESET or PERSONAL		FRESH	BREAD PIZZA FIRST	
		FROZEN		
		WHOLE	MEAT	TYPE OF ACCESSORY
		IN PIECES		
		WHOLE	POULTRY	LEVEL POSITION
		IN PIECES		FOOD WEIGHT
		WHOLE	FISH	COOKING TIME
		IN PIECES		
		-	VEGETABLES	PREHEAT REQUIRED (YES/NO)
		-	PIES	









Select a preset recipe

- ① Press  then press .
- ② Press   to choose from 'PRESET' or 'PERSONAL' and confirm your selection by pressing .
- ③ Choose the type of food to be cooked by pressing   and   and confirm your selection by pressing .
- ④ Press   to choose from 'FRESH' or 'FROZEN' options or from 'WHOLE' or 'IN PEICES' confirm your selection by pressing .
- ⑤ Select a recipe by pressing   confirm your selection by pressing .
- ⑥ When the recipe is confirmed, the following display page appears on the screen.
- ⑦ To start the cooking, confirm by pressing . During a recipe, a number of tones will signify visual messages appearing on the display. Follow these instructions to complete cooking the recipe.
- ⑧ A series of beeps along with a message on the display will indicate that the recipe is completed and the oven will switch off.



Saving a personalized recipe

When a recipe has been selected, the 'Time' and 'Weight' can be changed and the recipe can be saved among the 'PERSONAL' ones. This will allow you to quickly access your favourite recipes.

- ① When a recipe has been selected, press  and confirm your selection by pressing .
- ② Change the weight by pressing   and confirm your selection by pressing .
- ③ Change the cooking time by pressing   and confirm your selection by pressing .



Select an already-set recipe

- ④ By selecting 'SAVE' and confirming this selection by pressing ✓, the recipe will now be saved in the 'PERSONAL' list of recipes.

NOTE: If the time and weight is changed and not saved immediately at the end of the recipe, a message appears which asks whether you want to save it.

- ⑤ To start the recipe press ✓.



Removing a personalized recipe







To remove a recipe from the list of personalized recipes:

- ① Select the recipe you want to remove. Then press ◀ the recipe.
- ② A message 'Do you want remove the recipe' will appear on the display. Select 'Yes' and press ✓.







Oven clean

This function performs a cleaning cycle by injecting steam into the cavity for 15 minutes. At the end of the cycle, any crusting that may have formed due to high-temperature cooking inside the oven cavity, will be softened and become much easier to remove.

- ① Press . Press   to select  and confirm your selection by pressing .
- ② To cancel this function press  and then press .

Circuit clean

This function performs a cleaning cycle of the circuit, to keep it clean and operating efficiently. Press . Press   to select  and confirm your selection by pressing .

IMPORTANT!

Once the functions have been completed, a circuit discharge request will be sent (see WATER DISCHARGE paragraph).

This oven does not require any descalers to keep the steam generation system running efficiently.

Circuit discharge

At the end of any steam function, when the oven is turned off. The following message will appear on the display: NEED TO DISCHARGE/OPEN THE DOOR.

Carefully open the door as hot steam will be released. A message will appear on the display to remove the container and empty the water to the level indicated. When the water has been emptied, re-insert the container and press .

At the end of this function, the message DISCHARGE ENDED REMOVE AND EMPTY THE TANK will appear on the display, confirming that the discharge was successful. If you do not wish to immediately repeat a new steam cooking cycle, it is recommended to empty the container refill it with fresh water, reinsert the container and close the door. The oven is now ready for a new cooking cycle.

IMPORTANT!

If the electricity is interrupted, the oven requires you to empty the circuit once it turns back on, regardless of whether there is water in it or not.

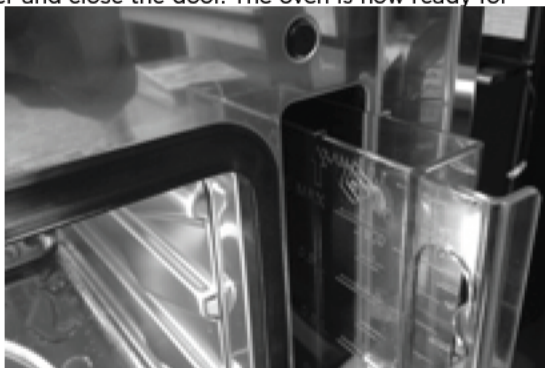

REPLACING THE OVEN LAMP

The oven lamp must have the following specifications.

- Structure suitable for high temperatures up to 572°F (300°C).
- Power supply: see the V/Hz value on the serial number plate.
- Power 25W.
- Type G9 connector.

IMPORTANT!

Ensure the appliance is off before replacing the lamp to avoid the possibility of electric shock.

- To protect the oven cavity, spread a tea towel inside the oven.
- Remove the screws holding the steel frame.
- Remove the old lamp by sliding it out of its socket and taking care not to break it.
- Insert the new bulb taking care not to touch it with your hands (we recommend using a disposable latex glove when handling the bulb).
- Replace the stainless steel frame taking care not to pinch the silicone gasket seal.
- Re-insert the screws that were previously removed.
- Re-connect the oven to power.

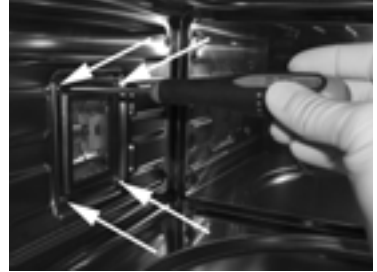

TROUBLESHOOTING

Cooking problems

If there is a problem, check the chart below to see if you can fix it.

If the problem cannot be fixed or persists, call your Authorised Repairer or Customer Care.

PROBLEM	POSSIBLE CAUSE
Food browns unevenly	<ul style="list-style-type: none">- Oven is not preheated- Aluminum foil on oven rack or oven bottom- Baking pan is too large for recipe- Baking pans are touching each other or oven walls
Food too brown on bottom	<ul style="list-style-type: none">- Oven is not preheated- Using glass, dull or darkened metal pans- Incorrect rack position- Baking pans are touching each other or oven walls
Food is dry or has shrunk excessively	<ul style="list-style-type: none">- Oven temperature too low- Oven not preheated
Food is baking or roasting too slowly	<ul style="list-style-type: none">- Oven door opened frequently during cooking- Food is tightly sealed with aluminum foil- Pan size too small
Pie crusts do not brown on bottom or have soggy crust	<ul style="list-style-type: none">- Baking time is not long enough- Using shiny steel pans- Rack position is incorrect- Oven temperature is too low
Cakes pale, flat and may not be cooked inside	<ul style="list-style-type: none">- Oven is temperature too low- Baking time is not long enough- The cake has been tested too soon- The oven door has been opened too often during baking- Baking pan size may be too large
Cakes high in middle with crack on top	<ul style="list-style-type: none">- Baking temperature is too high- Baking time is too long- Baking pans are touching each other or oven walls- Rack position is incorrect- Baking pan size may be too small
Pie crust edges too brown	<ul style="list-style-type: none">- Oven temperature too high- Edges of crust is too thin

TROUBLESHOOTING

OVEN PROBLEM	PROBLEM SOLVING STEPS
Other F__ Error appears in the display window	Remove power and turn it back on again after a few seconds. If condition persists, note the code number (in the EVENT LOG list) and contact Customer Support or your authorised repairer.
The oven display won't turn on	Turn off power at the main power supply, then turn the power back on. If this does not resolve the issue, call Customer Support or an authorised repairer.
The cooling fan continues to run after the oven is turned off	The fan will turn off automatically when the electronic components have cooled sufficiently.
Oven is not heating	Check the circuit breaker or fuse box to your house. Check that power is being supplied to the oven. Make sure the oven temperature has been selected.
Oven is not cooking evenly	Refer to cooking charts for recommended rack position. Always reduce recipe temperature by 25°F (15°C) when baking with True Convection mode.
Oven light is not working properly	Check that power is being supplied to the oven. Refer to the clock section of this userguide.
Clock and timer are not working properly	Make sure there is proper electrical power to the oven.
Excessive moisture	Using the convection mode will eliminate any moisture in the oven.
Turning off demo mode	To disable the function, press the arrows ◀ ▶ to enter the DEMO display page and select off. Confirm your selection by pressing ✓.

WARRANTY AND SERVICE

Before you call for service or assistance...

Check the things you can do yourself. Refer to the installation instructions and your user guide and check that:

- ① Your product is correctly installed.
- ② You are familiar with its normal operation.

If after checking these points you still need assistance or parts, please refer to the Service & Warranty book for warranty details and your nearest Authorised Service Centre, Customer Care, or contact us through our website fisherpaykel.com.

Complete and keep for safe reference:

Model _____
Serial No. _____
Purchase Date _____
Purchaser _____
Dealer _____
City _____
State _____
Zip _____
Country _____

FISHERPAYKEL.COM

© Fisher & Paykel Appliances 2018. All rights reserved.

The product specifications in this booklet apply to the specific products and models described at the date of issue. Under our policy of continuous product improvement, these specifications may change at any time. You should therefore check with your Dealer to ensure this booklet correctly describes the product currently available.

US CA

591474B 07.18