

FISHER & PAYKEL

CLASSIC RANGEHOOD

HC90PCTX1, HC90PCB1, HC90PCW1 and
HC90PCR1 models

USER GUIDE

NZ AU

CONTENTS

Introduction	5
Safety and warnings	6
Control panel	8
Care and cleaning	9
Parts and accessories	12
Warranty and service	13

IMPORTANT! **SAVE THESE INSTRUCTIONS**

The models shown in this User guide may not be available in all markets and are subject to change at any time. For current details about model and specification availability in your country, go to our website fisherpaykel.com or contact your local Fisher & Paykel dealer.

Registration

Register your product with us so we can provide you with the best service possible.

To register your product visit our website: fisherpaykel.com

INTRODUCTION

Thank you for purchasing a Fisher & Paykel product.

Thousands of hours go into the design, engineering, testing and perfecting of each Fisher & Paykel appliance. The care and attention given to creating these beautiful products doesn't stop once it has found its home with you.

This user guide will answer most of your questions about the set-up, use and on-going maintenance of your Fisher & Paykel product; however if you require further information about your product and its use please consult our website for solutions and further contact information to discuss with a service representative.

To ensure you receive all relevant product updates and the best service possible, please register your Fisher & Paykel products through our website.

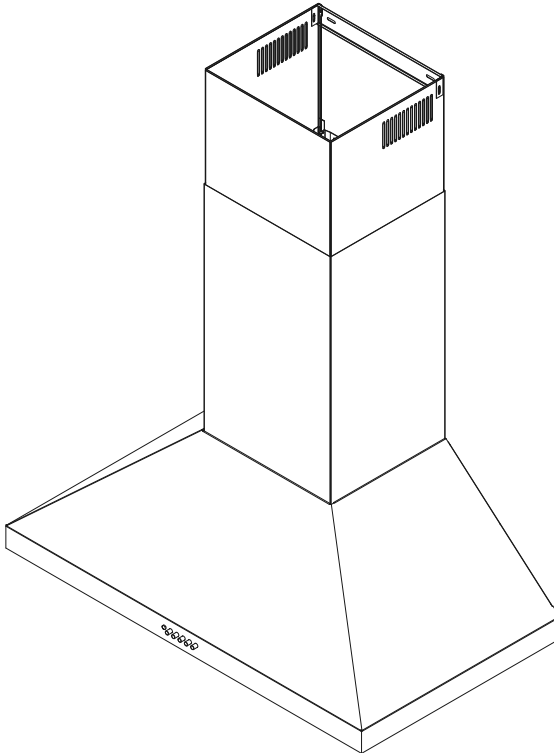

⚠ WARNING!



Electric Shock Hazard

Failure to follow this advice may result in electric shock or death.

- This appliance is equipped with a three-prong or four-prong grounding plug for your protection against shock hazard and should be plugged directly into a properly grounded power outlet.
- Never remove the grounding plug or use with a 2 prong adapter.
- Do not immerse cord or plugs in water or other liquid.

⚠ WARNING!



Weight Hazard

Failure to follow this advice may result in personal injury

- The appliance is heavy. Please ensure adequate care is taken when installing the appliance to prevent personal injury. The appliance must be installed onto a solid wall, stud, beam or truss.
- **Product weight:** 23 kg.

SAFETY AND WARNINGS

WARNING!

When using this appliance always exercise basic safety precautions including the following:

- Please read the entire set of instructions before installing or using this appliance.
- There shall be adequate ventilation of the room when the rangehood is used at the same time as appliances burning gas or other fuels.
- This appliance is not intended for use by persons (including children) with reduced physical, sensory or mental capabilities, or lack of experience and knowledge, unless they have been given supervision or instruction concerning the use of the appliance by a person responsible for their safety.
- Children should be supervised to ensure they do not play with the appliance. Cleaning and user maintenance shall not be made by children without supervision.
- You must read the details concerning the method and frequency of cleaning.
- There is a fire risk if cleaning is not carried out in accordance with the instructions.
- Never leave frying food unattended since grease can overheat and catch fire. The risk of fire is even greater in the case of used oil.
- Do not flambé under the rangehood.
- Never use the rangehood without the filters in place.
- CAUTION: accessible parts may become hot when used with cooking appliances.
- Remove all packaging, including protective wrappings, before use.
- Unplug or disconnect the appliance from the power supply before servicing or cleaning.
- The rangehood may stop working during an electrostatic discharge (eg lightning). Switch off the electricity supply to the rangehood and reconnect after one minute.
- Never use abrasive or oil based cleaners
- Wear gloves to protect against sharp edges
- When replacing the bulb, let the bulb cool, and assure that power to the rangehood has been turned off.
- Use new bulbs according to that indicated on the rangehood nameplate.
- ILCOSD CODE FOR LED BULBS: DRR-3.5-220/240-GU10-50/50

CONTROL PANEL



Control panel features

- ① Fan on Indicator
- ② Light
- ③ Fan off switch
- ④ Fan speed 1
- ⑤ Fan speed 2
- ⑥ Fan speed 3

CARE AND CLEANING

This rangehood should be cleaned regularly using a mild, liquid detergent and a clean soft cloth to avoid a build-up of grease occurring. Avoid the use of corrosive chemicals, abrasive cleaning products, hard brushes and steel wool pads. Grease deposits are corrosive which can cause damage.

In areas of high humidity or coastal environments, cleaning should be carried out more frequently. Disconnect the product from the power source before undertaking any cleaning.

Do not operate the hood without filters in place.

Aluminum filters

- Clean the filters at least once a month. Filters may need to be cleaned more frequently depending on the cooking methods used and frequency of use.
- Aluminum filters should be removed and cleaned with hot soapy water or in a dishwasher.
- If washed in a dishwasher, the filter should be placed in an upright position to prevent food from falling on them.
- After rinsing and drying, refit the filters.

Removing the aluminium filters

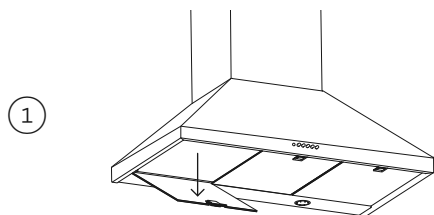

Pull the catch and tilt the filter downwards until it disengages from the supports.

Replacing the aluminium filters

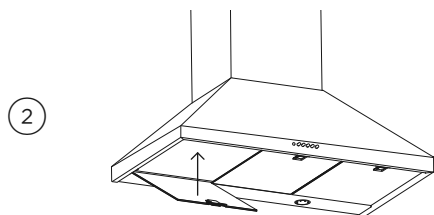

Place the filter into the support at the rear of the rangehood. Push the filter back into place.

CARE AND CLEANING

Carbon filters - for use in recirculation mode

Active carbon filters are disposable items designed to remove grease and odours from cooking vapours before the air is channelled back into the kitchen. The active carbon filters must be replaced periodically to work properly, at least once every three months, depending on the frequency with which the rangehood is used.

Fully saturated carbon filters can become a barrier to air movement therefore limiting rangehood performance. In the event of fire, grease laden filters could be flammable and therefore regular replacement is recommended.

CARE AND CLEANING

Replacing the light bulb

①

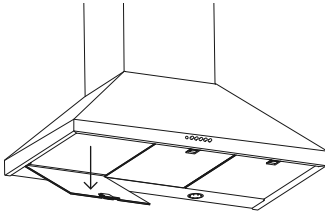

Remove the aluminum filters.

②

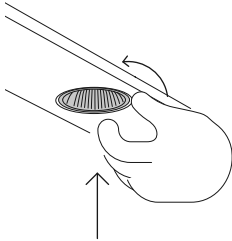

Lightly push the light bulb up and rotate anti-clockwise to remove.

③

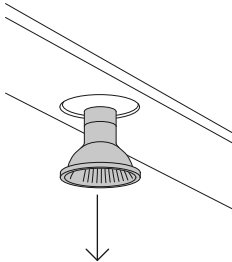

Replace light bulb with a light bulb no more powerful.
Refer to rangehood rating plate for detail.

④

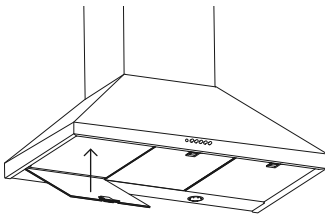

Refit the aluminum filters.

PARTS AND ACCESSORIES

ITEM	REFERENCE NUMBER
LED bulb	792603
Aluminium filters with stainless steel cover	792558
Recirculation carbon filter x2	792481
Recirculation diverter	792560

WARRANTY AND SERVICE

Before you call for service or assistance

Check the things you can do yourself. Refer to the installation guide and user guide and check that:

- Your product is correctly installed.
- You are familiar with its normal operation.

If after checking these points you still need assistance or parts, please refer to the Service & Warranty book for warranty details and your nearest Service Center, Customer Care, or contact us through our website www.fisherpaykel.com

Complete and keep for safe reference:

Model	_____
Serial No.	_____
Purchase Date	_____
Purchaser	_____
Dealer	_____
Suburb	_____
Town	_____
Country	_____

FISHERPAYKEL.COM

© Fisher & Paykel Appliances 2019. All rights reserved.

The product specifications in this document apply to the specific products and models described at the date of issue. Under our policy of continuous product improvement, these specifications may change at any time. You should therefore check with your Dealer to ensure this document correctly describes the product currently available.

NZ AU
105936A 12.19