

# Oven, 24", 16 Function, Self-cleaning

Series 9 | Contemporary

Stainless Steel



A highlight of the Fisher & Paykel collection, this Series 9 oven with touchscreen guided cooking helps to ensure every dish is cooked to perfection.

- Touchscreen guided cooking capability offers helpful tips for different food types as well as full recipes
- 3 cu ft total capacity, with 16 oven functions including Pastry Bake, Roast, Air Fry and Dehydrate
- Moisture level control with ActiveVent technology
- Pyrolytic self-cleaning function breaks down food residue for an easy clean

## DIMENSIONS

|        |          |
|--------|----------|
| Height | 23 9/16" |
| Width  | 23 7/16" |
| Depth  | 22 1/4"  |

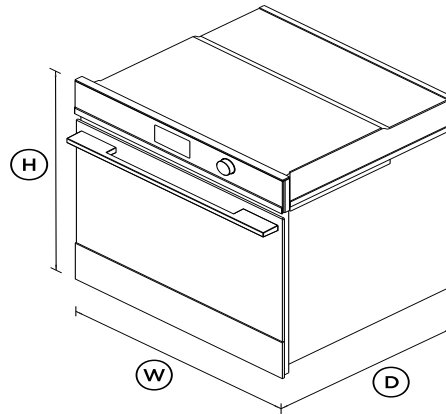

## FEATURES & BENEFITS

### Cook with confidence

Using the large 5" touchscreen interface, you can cook with a favourite method, a hero ingredient, or a go-to cooking function or recipe. Your oven will guide you through the steps, or change the temperature and heat type automatically, depending on your selection.

### Generous capacity

With an exceptional 3 cu ft total capacity, you can create several

perfectly cooked dishes at once using multiple shelves. Non-tip, full-extension shelves help to ensure safe removal of hot dishes.

### Exceptional performance

Our unique cooking technologies were developed to deliver perfect results. ActiveVent ensures optimized moisture levels, while AeroTech™ circulates heat evenly for a consistent temperature.

### Safe and sound

The CoolTouch door of this built-in oven is safe to touch from the outside. Sturdy, fully extendable shelves slide all the way out, reducing the need for you to reach inside.

### Self-cleaning

Pyrolytic self-clean breaks down food residue at a very high temperature, leaving a light ash that's easily removed with a damp cloth. The enamel coated side racks don't need to be removed when using this function.

### Design freedom

Designed to fit seamlessly into your kitchen, this built-in oven features premium materials and detailing to support a cohesive, considered kitchen design.

### Multi-function flexibility

Each function has been tailored, tested and perfected to ensure that no matter what you're cooking, you've got the right heat to match. Purchase our Wireless Temperature Sensor accessory and precisely monitor cooking in real time (accessory sold separately).

## SPECIFICATIONS

### Accessories

|                                |       |
|--------------------------------|-------|
| Broil grid                     | 1     |
| Broil pan                      | 1     |
| Broil rack                     | 1     |
| Full extension sliding shelves | 1 set |

|                               |   |
|-------------------------------|---|
| Pyrolytic proof shelf runners | • |
| Step down wire shelf          | 1 |
| Wired temperature sensor      | 1 |

**Capacity**

|                 |          |
|-----------------|----------|
| Shelf positions | 6        |
| Total capacity  | 3cu ft   |
| Usable capacity | 2.5cu ft |

**Cleaning**

|                                |   |
|--------------------------------|---|
| Acid resistant graphite enamel | • |
| Pyrolytic proof shelf runners  | • |
| Pyrolytic self-clean           | • |
| Removable oven door            | • |
| Removable oven door inner      | • |
| Removable shelf runners        | • |

**Consumption**

|                      |                 |
|----------------------|-----------------|
| Energy usage         | 308kWh/year     |
| In-use energy carbon | 38.0kgCO2e/year |

**Controls**

|                              |   |
|------------------------------|---|
| Adjustable audio and display | • |
| Automatic cooking/minute     | • |
| Automatic pre-set            | • |
| Celsius/Fahrenheit           | • |
| Delay start                  | • |
| Electronic clock             | • |
| Electronic oven control      | • |
| Food probe                   | • |

|                               |                         |
|-------------------------------|-------------------------|
| Guided cooking by food type   | •                       |
| Halogen lights                | •                       |
| Intuitive touchscreen display | •                       |
| Multi-language display        | UK English, US English, |
| Sabbath mode with Star K      | •                       |
| Soft close doors              | •                       |
| True convection oven          | •                       |
| Turned stainless steel dials  | •                       |
| Wi-Fi connectivity            | •                       |

**Functions**

|                     |    |
|---------------------|----|
| Aero Bake           | •  |
| Aero Broil          | •  |
| Air fry             | •  |
| Bake                | •  |
| Broil               | •  |
| Classic bake        | •  |
| Dehydrate           | •  |
| Number of functions | 16 |
| Pastry Bake         | •  |
| Pizza bake          | •  |
| Rapid proof         | •  |
| Roast               | •  |
| Self-clean          | •  |
| Slow cook           | •  |
| True Aero           | •  |
| Vent bake           | •  |
| Warm                | •  |

**Performance**

|                          |                |
|--------------------------|----------------|
| ActiveVent™ system       | •              |
| AeroTech™ technology     | •              |
| Automatic rapid pre-heat | •              |
| Temperature range        | 95 °F - 540 °F |

**Power requirements**

|                  |              |
|------------------|--------------|
| Amperage         | 16.6 - 19.4A |
| Supply frequency | 60Hz         |
| Supply voltage   | 208-240V     |

**Product dimensions**

|        |          |
|--------|----------|
| Depth  | 22 1/4"  |
| Height | 23 9/16" |
| Width  | 23 7/16" |

**Safety**

|                          |   |
|--------------------------|---|
| ADA compliant            | • |
| Balanced oven door       | • |
| Catalytic venting system | • |
| Control panel key lock   | • |
| CoolTouch door           | • |
| Non-tip shelves          | • |
| Safety thermostat        | • |

**Warranty**









|                  |         |
|------------------|---------|
| Parts and labour | 2 years |
|------------------|---------|

|     |       |
|-----|-------|
| SKU | 82525 |
|-----|-------|

The product dimensions and specifications in this page apply to the specific product and model. Under our policy of continuous improvement, these dimensions and specifications may change at any time. You should therefore check with Fisher & Paykel's Customer Care Centre to ensure this page correctly describes the model currently available. ? Fisher & Paykel Appliances Ltd 2020

---

**Other product downloads available at fisherpaykel.com**

-  [Energy Label](#)
-  [Service & Warranty](#)
-  [User Guide Oven EN](#)
-  [Installation Guide Wall Oven EN](#)
-  [Guía de instalación SP](#)
-  [Guide d'installation FR](#)
-  [Preliminary Specification Guide Wall Oven](#)
-  [Datasheet Oven](#)



**A PEACE OF MIND SALE**

**24 Hours 7 Days a Week Customer Support**

**T 1.888.936.7872 W [www.fisherpaykel.com](http://www.fisherpaykel.com)**