

60cm Series 9 Contemporary Vacuum Seal Drawer

Contemporary

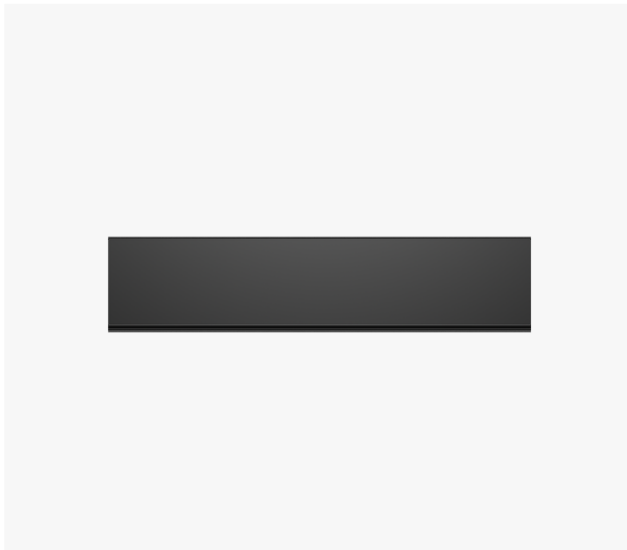

Prepares food for sous vides cooking, with vacuum sealing for marinating, storing, portioning and resealing.

- Effortless preparation for sous vide cooking
- Three levels of vacuum and heat sealing for food storage, marinating or portioning
- Intuitive touch controls for ease of use
- Part of our suite of companion products, designed to match for flexible configurations

DIMENSIONS

Height	140 mm
Width	596 mm
Depth	566 mm

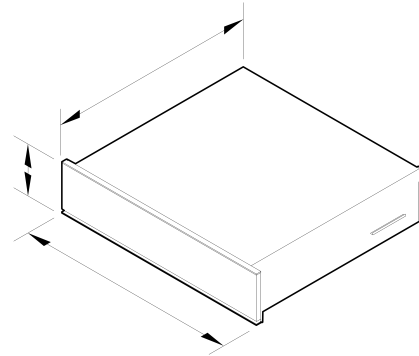

FEATURES & BENEFITS

Complementary design

Our Vacuum Seal Drawer comes with the option of a stylish black glass panel or elegant grey glass panel, for seamless pairing with our Minimal or Contemporary style ovens.

Three levels of vacuum heat and sealing

Vacuum sealed food intensifies flavours, infuses marinades and retains freshness. Effortlessly prepare food for sous vide cooking in optimal conditions.

Preserve freshness

Vacuum sealing creates the ideal conditions for longer food shelf life and storage. Minimal air exposure hinders the growth of bacteria and mould, preventing freezer burn and protecting your food.

Easy to use

This Vacuum Seal Drawer is handle-free, push-to-open for effortless loading and operating. The touch controls are responsive and intuitive for ease of use.

Reduce food waste

Our Vacuum Seal drawers help to extend the lifespan of food by removing excess air, which is the prime reason for spoilage. Vacuum sealing allows you to buy food in bulk and safely seal it for longer shelf life. Our food-grade, BPA-free bags are an excellent storage option – these can be re-used if sealed and cut appropriately.

Easy to clean

The stainless steel interior can be wiped down with a damp cloth for easy cleaning.

SPECIFICATIONS

Accessories (included)

External vacuuming accessory kit	Adapter, stopper and tube
Large size BPA-free vacuum seal bags	50 bags, Part 793034
Small size BPA-free vacuum seal bags	50 bags, Part 793033

Capacity

Maximum vacuum seal bag size	240mm x 350mm
Usable capacity	7.8 L

Usable height **85 mm**

Supply voltage **240 V**

Cleaning

- Easy clean glass lid
- Easy clean stainless steel interior
- Removable sealing bar and cover

Product dimensions

- Adjustable front door panel to align with surrounding cabinetry
- Depth **566 mm**
- Height **140 mm**
- Width **596 mm**

Controls

- Audio feedback
- Electronic capacitive touch controls
- Maintenance and moisture indicator
- Push-to-open drawer
- Standby mode

Safety

- BPA-free vacuum seal bags **100 bags included**
- Full extension slides

SKU **84238**

Performance

- External vacuuming
- Prepare food for sous-vide cooking
- Pump power **150**
- Pump pressure **10 Bar**
- Vacuum levels **3**
- Vacuum sealing levels **3**

The product dimensions and specifications in this page apply to the specific product and model. Under our policy of continuous improvement, these dimensions and specifications may change at any time. You should therefore check with Fisher & Paykel's Customer Care Centre to ensure this page correctly describes the model currently available. © Fisher & Paykel Appliances Ltd 2020

Other product downloads available at fisherpaykel.com

- [↓](#) DWG
- [↓](#) DXF
- [↓](#) Planning Guide - 60cm Contemporary Stainless Steel (English)
- [↓](#) User Guide (English)

Power requirements

- Amperage **10 A**
- Power cord length **1800 mm**
- Power outlet **3-prong grounding-type**
- Supply frequency **60 Hz**

Where applicable:

All appliances use energy, and energy usage typically generates carbon emissions. **Fisher & Paykel Appliances' In-use Energy Carbon Emissions Estimate** indicates carbon emissions from a product's in-use energy. This is calculated either annually or per cycle, using the product's market-specific energy label energy consumption data multiplied by the carbon emissions factor for energy in your country or region.

Our In-use Energy Carbon Emissions Estimate is designed to assist customers in making informed purchasing decisions when comparing different Fisher & Paykel products. For example, a heat pump dryer typically has a lower In-use Energy Carbon Emissions Estimate than a vented dryer.



A PEACE OF MIND SALE
24 Hours 7 Days a Week Customer Support
 T 0800 372 273 W www.fisherpaykel.com