

17 cu ft Series 7 French Door Refrigerator Freezer

Contemporary



Designed for those who need plenty of flexible space for their cold and frozen food storage, with a stylish stainless steel finish.

- ActiveSmart™ helps keep food fresher for longer
- Bottom freezer drawer
- Brushed metal handles

DIMENSIONS

Height 67 3/4 "

Width 31 1/8 "
Depth 27 3/8 "

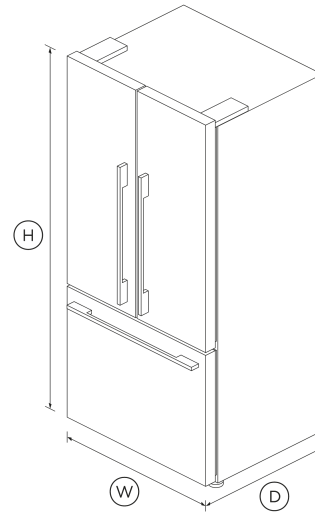

FEATURES & BENEFITS

Activesmart™ Foodcare

ActiveSmart™ technology understands that the refrigerator door is the most opened in the house. It constantly adjust temperature, airflow and humidity, maintaining an optimum environment and helping keep food fresher for longer.

Design Quality

Our refrigerators are designed and built using quality materials. We use real stainless steel on our refrigerators and solid glass for shelving.

Easy Cleaning

No more permanent dirty marks with our EZKleen feature for stainless steel refrigerators. Anti-fingerprint coating means you simply wipe clean any marks. Spill-safe secure glass shelves easily capture any drips or leaks.

Clever Energy

Your refrigerator adapts to daily use by cooling and defrosting only when needed. This means your refrigerator uses the energy it needs without compromising on food care.

Complementary Design

With their premium handle styling and stainless steel finish, our refrigerators are designed to match the rest of Fisher & Paykel's kitchen appliance family.

SPECIFICATIONS

Capacity

Total gross capacity	16.9 cu ft
Volume freezer	4.8 cu ft
Volume refrigerator	12.1 cu ft

Connected Features

- Alerts and notifications
- Education and onboarding
- Remote operation
- Software updates

Consumption

Energy rating	Energy Star
Energy usage	448kWh/year
In-use energy carbon emissions estimate	51.7kgCO2e/year

Features

Adjustable door shelves	8
Adjustable glass shelves	3
Covered door shelves	2
Door alarm	•
Fruit and vegetable bins	2
LED lighting	•
Smart appliance	•
SmartTouch control panel	•
Stackable bottle holders	4

Freezer Features

Bottle chill	•
Fast freeze	•
Ice trays	1

Performance

ActiveSmart™ Foodcare	•
Adaptive defrost	•
Frost free freezer	•
Humidity control system	•
Sabbath mode	•

Power requirements

Rated current	10 A
Supply frequency	60 Hz
Supply voltage	115 V

Product dimensions

Depth	27 3/8 "
Height	67 3/4 "
Minimum air clearance at rear	1 3/16 "
Minimum air clearance each side	1 3/16 "
Width	31 1/8 "

SKU 26283

The product dimensions and specifications in this page apply to the specific product and model. Under our policy of continuous improvement, these dimensions and specifications may change at any time. You should therefore check with Fisher & Paykel's Customer Care Centre to ensure this page correctly describes the model currently available. © Fisher & Paykel Appliances Ltd 2020

Other product downloads available at fisherpaykel.com

- [↓](#) DWG
- [↓](#) DXF
- [↓](#) Data Sheet (English)
- [↓](#) Energy Label
- [↓](#) Installation Guide (English)
- [↓](#) Installation Guide (English)
- [↓](#) Water Filter Replacement Instructions - Parts 847200 and 847201 (French)
- [↓](#) Installation Guide (Canadian French)
- [↓](#) Right To Repair Declaration (English, Canadian French)
- [↓](#) User Guide (English)
- [↓](#) User Guide (Canadian French)

Where applicable:

All appliances use energy, and energy usage typically generates carbon emissions. **Fisher & Paykel Appliances' In-use Energy Carbon Emissions Estimate** indicates carbon emissions from a product's in-use energy. This is calculated either annually or per cycle, using the product's market-specific energy label energy consumption data multiplied by the carbon emissions factor for energy in your country or region.

Our In-use Energy Carbon Emissions Estimate is designed to assist customers in making informed purchasing decisions when comparing different Fisher & Paykel products. For example, a heat pump dryer typically has a lower In-use Energy Carbon Emissions Estimate than a vented dryer.



A PEACE OF MIND SALE
24 Hours 7 Days a Week Customer Support
 T 1.888.936.7872 W www.fisherpaykel.com