

FISHER & PAYKEL

SINGLE DISHDRAWER™ DISHWASHER

CONTEMPORARY

DD60SAW9, DD60SAX9, DD60SCW9, DD60SCX9, DD60SCTW9

DD60SCTX9, DD60SDFX9, DD60SDFTX9, DD60SDFTB9

INSTALLATION GUIDE

NZ AU UK IE

⚠ WARNING!

Electric Shock Hazard

Failure to follow this advice may result in electrical shock or death.

- Before installing the DishDrawer, remove the house fuse or open the circuit breaker.
- This appliance must be earthed. In the event of a malfunction or breakdown, earthing will reduce the risk of electric shock by providing a path of least resistance for electric current. This appliance is equipped with a cord having an equipment-earthing conductor and an earthing plug.
- The plug must be plugged into an appropriate outlet that is installed and earthed in accordance with all local codes and ordinances.
- **WARNING** - Improper connection of the equipment-earthing conductor can result in a risk of electric shock. Check with a qualified electrician or service representative if you are in doubt as to whether the appliance is properly earthed.
- Do not modify the power supply plug provided with the appliance - if it will not fit the outlet, have a proper outlet installed by a qualified electrician. Do not use an extension cord, adapter plug or multiple outlet box.



⚠ WARNING!

Cut Hazard

Failure to use caution could result in injury.

- Take care - panel edges are sharp.



WARNING!

To reduce the risk of fire, injury to persons or damage when using the appliance, follow the important safety instructions listed below. Read all the guidance before using the appliance.

Servicing

- Do not repair or replace any part of the appliance unless specifically recommended in this guide. All other servicing should be undertaken by a Fisher & Paykel trained and supported service technician or qualified person.

Installation

- Installation of this DishDrawer requires basic mechanical and electrical skills.
- Installation must comply with your local building and electricity regulations.
- Remove all packaging materials supplied with the dishwasher.
- Be sure to leave these Instructions with the Customer.
- At the completion of the installation, the Installer must perform the Final Checklist.
- This dishwasher is manufactured for indoor use only.
- Ensure all water connections are turned OFF. It is the responsibility of the plumber and electrician to ensure that each installation complies with all Codes and Regulations.
- The DishDrawer **MUST** be installed to allow for future removal from the enclosure if service is required.
- The switched power outlet must be outside the dishwasher cavity, so that it is accessible after installation.
- Care should be taken when the appliance is installed or removed to reduce the likelihood of damage to the power supply cord and hoses.
- If the DishDrawer is relocated from one installation site to another it must be kept upright to avoid damage from water spillage.
- Ensure only supplied hoses are used for connection. Old hoses should not be reused.
- Failure to install correctly could invalidate any warranty or liability claims.
- If the product is installed in a motor vehicle, boat or similar mobile facility, you must bring the vehicle, boat or mobile facility containing the product to the service shop at your expense or pay the service technician's travel to the location of the product.

SAVE THESE INSTRUCTIONS

The models shown in this installation guide may not be available in all markets and are subject to change at any time. For current details about model and specification availability in your country, please go to our website www.fisherpaykel.com or contact your local Fisher & Paykel dealer.

TOOLS AND COMPONENTS

PARTS SUPPLIED

- Keep all packing materials until the unit has been inspected.
- Inspect the product to ensure there is no shipping damage. If any damage is detected contact the dealer or retailer you bought the product from to report the damage.
- Fisher & Paykel is not responsible for shipping damage.

Supplied



Side mounting bracket kits (2)*

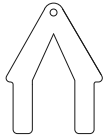

Top mounting bracket kit (1)*

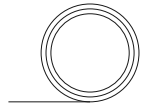

Moisture protection tape (1)



16mm Phillips screws (7)

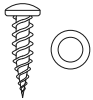

38mm bottom fixing screws and washers (2)



Rubber washer (1)**

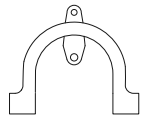

Drain hose support (1)

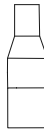

Drain hose joiner (1)



Wire clip (1)

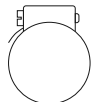

Clamp (1)

TOOLS REQUIRED

Not supplied

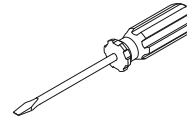

Flat-blade screwdriver

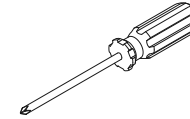

Powered driver

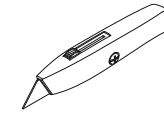

Box cutter

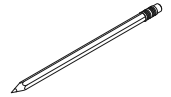

Pencil

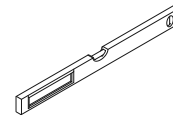

Level

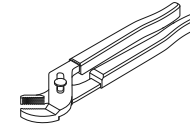

Pliers



Router

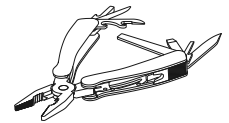

Multi-tool

INSTALL VIDEO

This video provides an overview of what is needed to install a DishDrawer™ Dishwasher. It is intended as an overview only of the installation process and is not intended to be used as a standalone guide on how to install a DishDrawer™ Dishwasher yourself. Installation should be undertaken by a Fisher & Paykel trained and supported service technician or qualified person.



To access installation videos

Scan the QR code with your smartphone or watch online at:
fisherpaykel.com/dishdrawer-install

PRODUCT DIMENSIONS — DD60SC MODELS

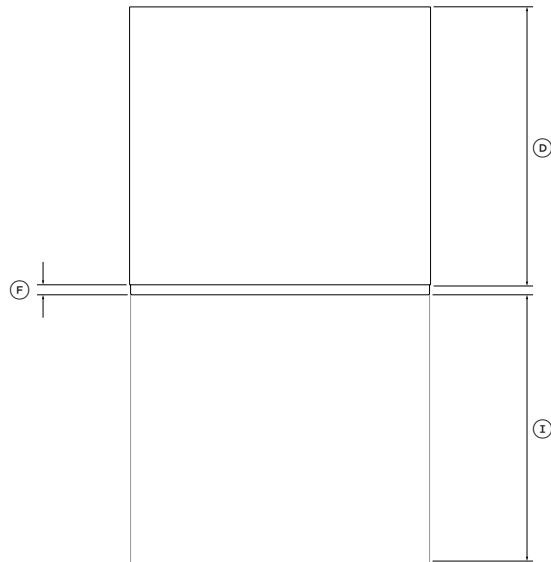

PLAN

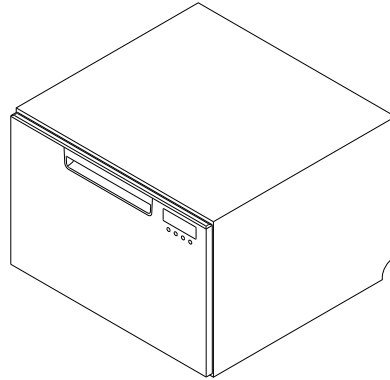

ISOMETRIC

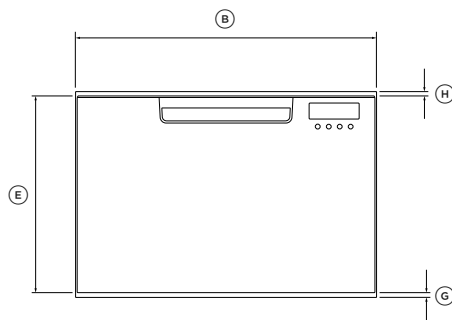

FRONT

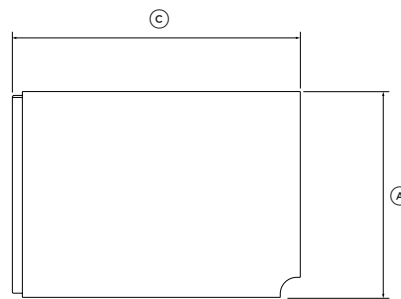

PROFILE

PRODUCT DIMENSIONS	DD60SC	DD60SCT
	MM	MM
Ⓐ Overall height	410	454
Ⓑ Overall width	599	599
Ⓒ Overall depth	573	573
Ⓓ Depth of chassis	553	553
Ⓔ Height of door panel	394	438
Ⓕ Depth of door panel	20	20
Ⓖ Ventilation gap below door panel	8	8
Ⓗ Height from top of drawer panel to top of chassis	8	8
Ⓘ Max. drawer extension from drawer front	547	547

Actual product dimensions may vary by ± 2mm

PRODUCT DIMENSIONS — DD60SD MODELS

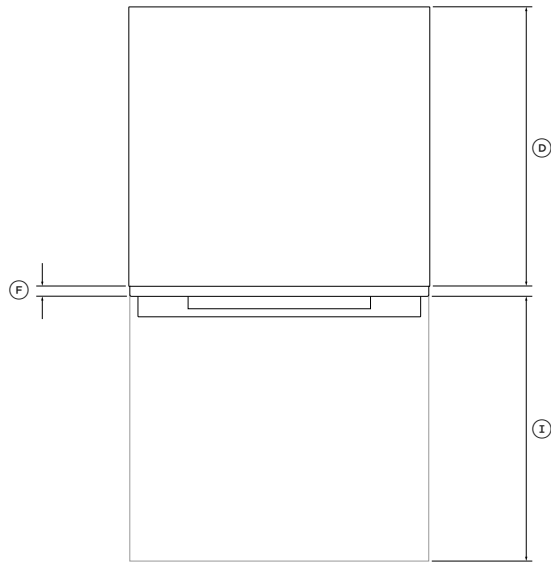

PLAN

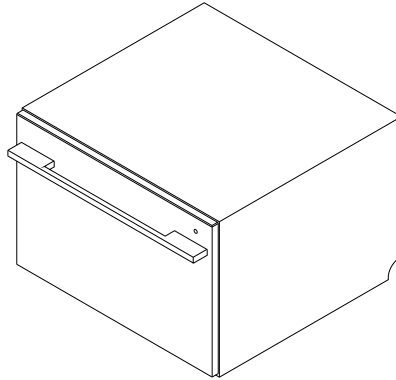

ISOMETRIC

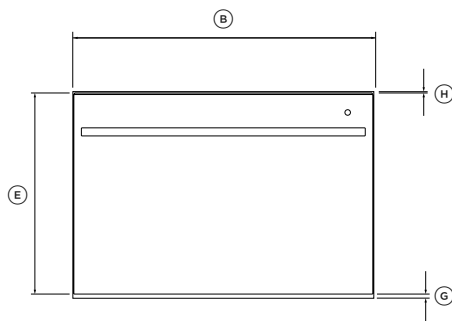

FRONT

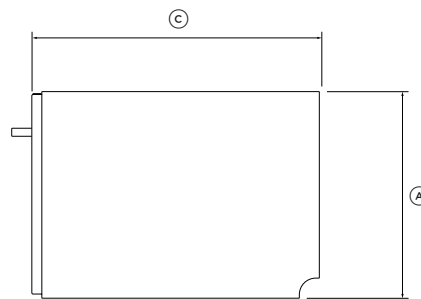

PROFILE

PRODUCT DIMENSIONS	DD60SD	DD60SDT
	MM	MM
Ⓐ Overall height	410	478
Ⓑ Overall width	599	599
Ⓒ Overall depth*	573	573
Ⓓ Depth of chassis	553	553
Ⓔ Height of door panel	398	470
Ⓕ Depth of door panel	20	20
Ⓖ Ventilation gap below door panel	8	8
Ⓗ Height from top of drawer panel to top of chassis	2	26
Ⓘ Max. drawer extension from drawer front	527	527

*excluding handle

PRODUCT DIMENSIONS — DD60SA MODELS

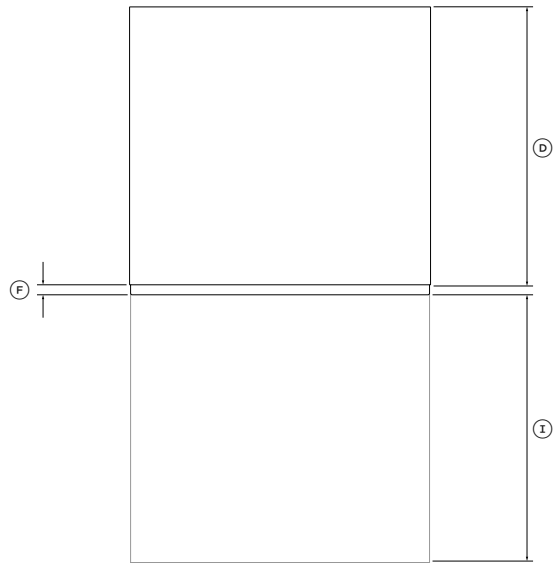

PLAN

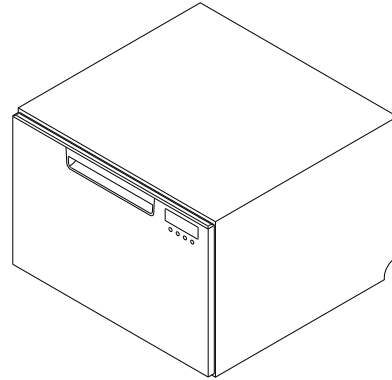

ISOMETRIC

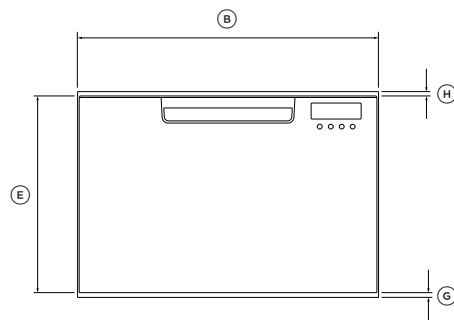

FRONT

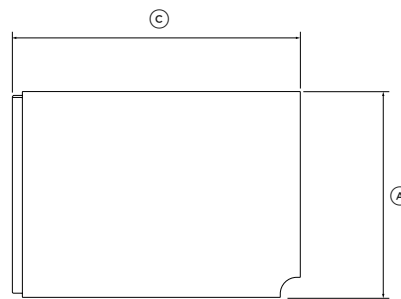

PROFILE

PRODUCT DIMENSIONS	DD60SA
	MM
Ⓐ Overall height	410
Ⓑ Overall width	599
Ⓒ Overall depth	573
Ⓓ Depth of chassis	553
Ⓔ Height of door panel	394
Ⓕ Depth of door panel	20
Ⓖ Ventilation gap below door panel	8
Ⓗ Height from top of drawer panel to top of chassis	8
Ⓘ Max. drawer extension from drawer front	547

Actual product dimensions may vary by ± 2 mm

CABINERY

DIMENSIONS

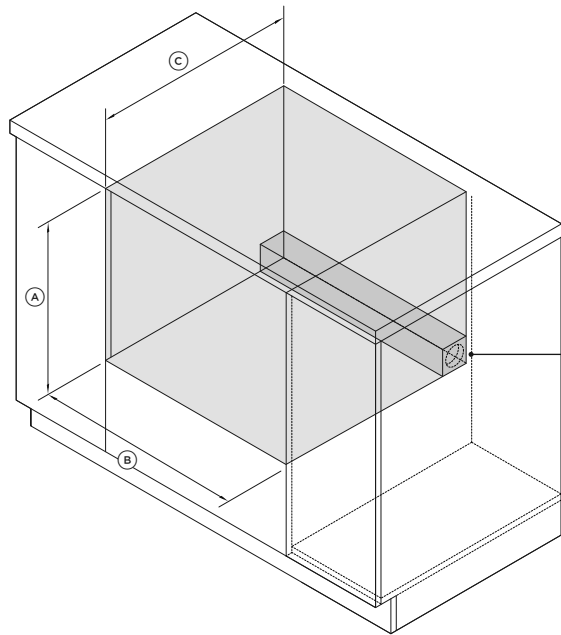

Connections can be located in an adjacent cabinet on either side of the DishDrawer***

ISOMETRIC

CABINERY DIMENSIONS	STD MODELS	TALL MODELS
	MM	MM
Ⓐ Minimum inside height*	min. 412	min. 456
Ⓑ Inside width**	600-610	600-610
Ⓒ Minimum inside depth	579	579

*depending on adjustment of levelling feet

**including 19mm door panels on adjacent cabinetry

***For more information on service requirements, refer to 'Plumbing & electrical considerations' and 'Cabinetry preparation'.

CLEARANCES

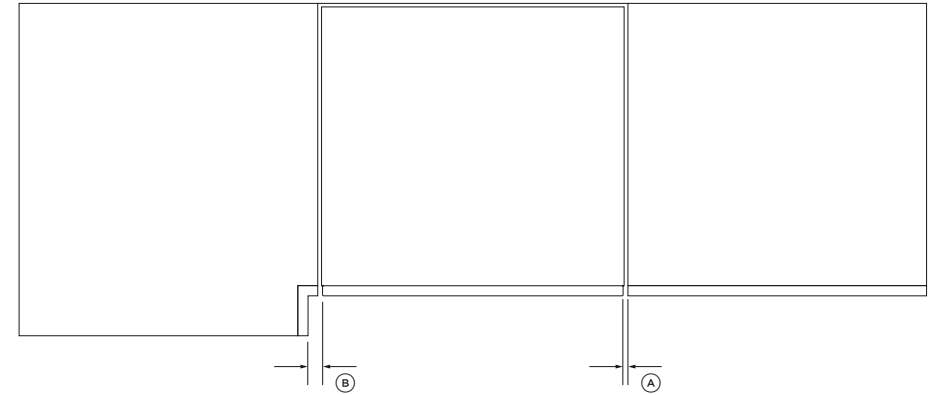

PLAN

CABINERY CLEARANCES	MM
Ⓐ Minimum clearance to adjacent cupboard door	2
Ⓑ Minimum clearance to corner cupboard	13

PLUMBING & ELECTRICAL CONSIDERATIONS

Hose and cord lengths

- Your services can be installed to **either** the left-hand or right-hand side of the product in an adjacent cabinet. Refer to 'Cabinetry preparation' for service access requirements.
- If the drain hoses supplied are not long enough to reach your services, you may purchase a Fisher & Paykel drain hose extension kit which will extend the drain hoses by 3.6m (part number 525798).

Water connection

- Recommended water temperature: Cold (maximum 60°C)
- 3/4" BSP (GB20) to suit flat washer
- Ensure water connection complies with local plumbing regulations.

Water pressure

- Water softener models: max. 1 MPa (145 psi), min. 0.1 MPa (14.5 psi)
- Non-water softener models: max. 1 MPa (145 psi), min. 0.03 MPa (4.3 psi)

Electrical requirements

- 220-240VAC min 4.2A

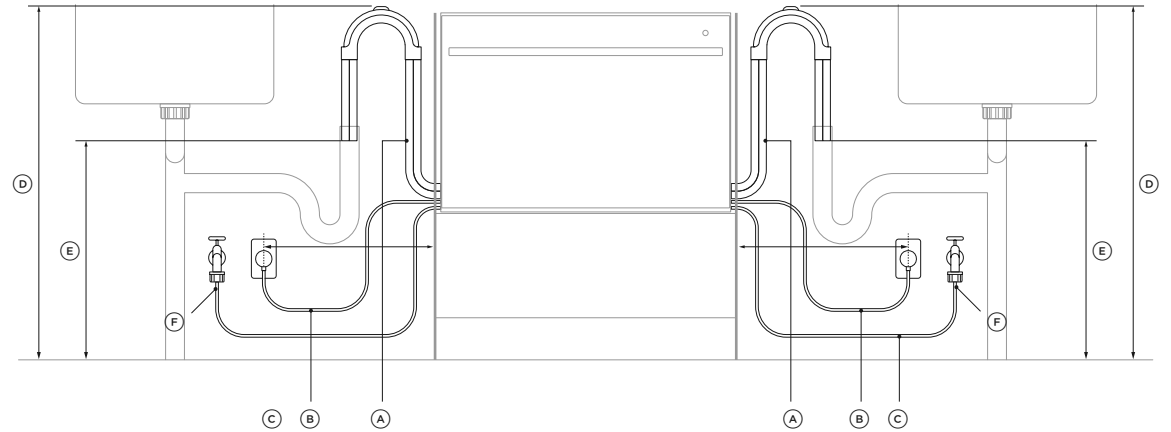

SERVICE DIMENSION	LEFT SIDE*	RIGHT SIDE*
	MM	MM
Ⓐ Length of drain hoses	2000	1800
Ⓑ Length of power cord**	1650	1650
Ⓒ Length of inlet hose	1650	1250
Ⓓ Distance from floor to top of hose support	750-883	750-883
Ⓔ Minimum distance from floor to end of drain hoses***	500	500
Ⓕ Minimum inlet hose radius	200	200
Ⓖ Maximum distance from cabinetry centre of electrical outlet	450	450

*dimensions taken from the chassis edge where applicable

**excluding plug

***standpipe install illustrated. Distance is the same for all plumbing installs.

CABINETY PREPARATION

SERVICE ACCESS

- We recommend locating the service holes on either side of the DishDrawer as shown below.
- If the hole is created through wood, ensure the edges are smooth and rounded
- If the hole is created through metal, ensure the edge protector is fitted.

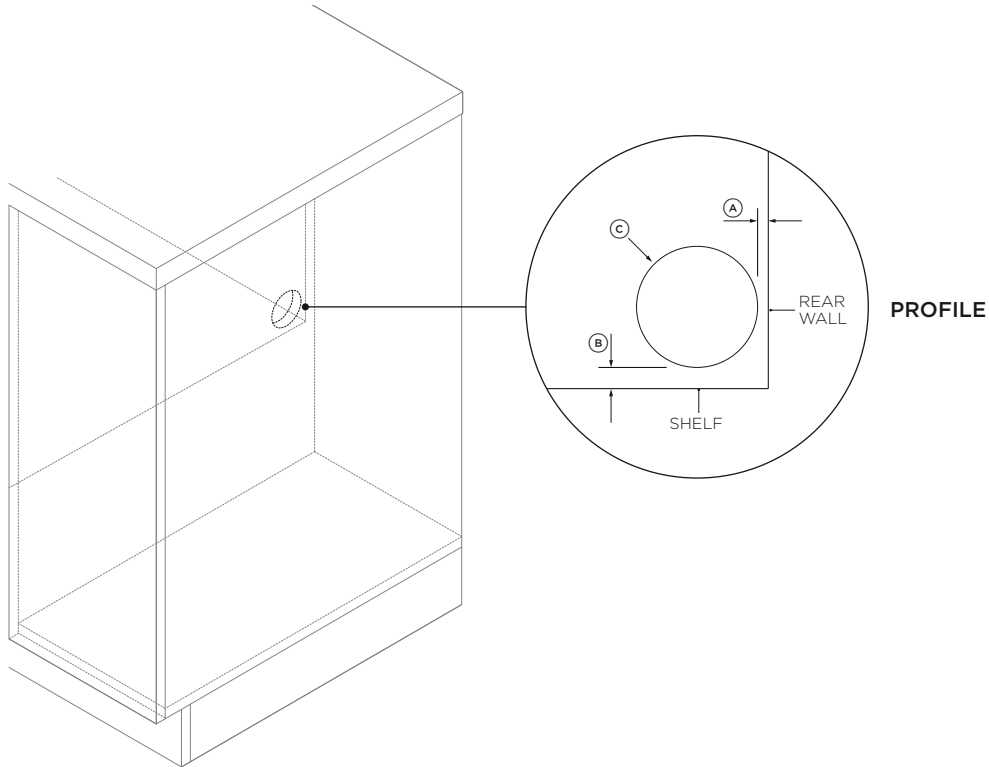

SERVICE HOLE DIMENSIONS

MM

Ⓐ	Maximum distance between rear of cavity and service hole	5
Ⓑ	Maximum distance between shelf and service hole	10
Ⓒ	Minimum diameter of service hole	57

MOISTURE PROTECTION

①

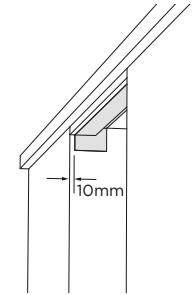

Align the supplied moisture protection tape to the cabinetry as illustrated

Ensure this area is free of debris before carefully applying the tape to the surface.

SIDE PARTITION

①

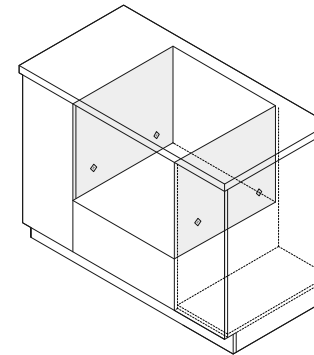

If securing via the drawer removal method, ensure the marked locations provide adequate support.

If there are no side partitions, construct timber bracing to secure the fixings to.

SELECT CABINETY SECURING METHOD

METHOD A Secure to cabinetry via brackets

Recommended method*

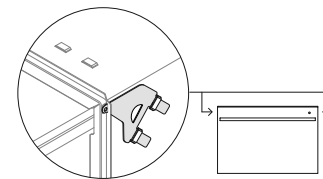

METHOD B Secure via drawer removal

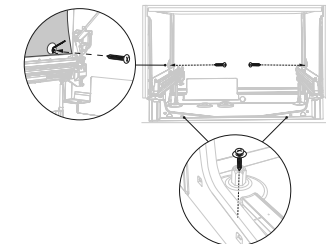

*Frameless cabinetry only

SECURE TO CABINETRY VIA BRACKETS (METHOD A)

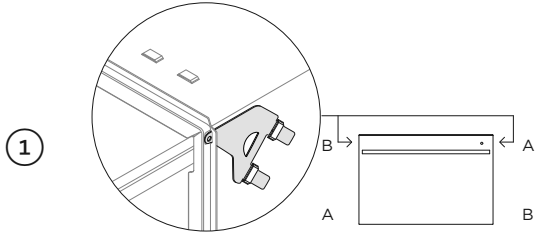

Secure all four side brackets to the DishDrawer™ Dishwasher, aligning bracket A with slot A and bracket B with slot B.

Ensure the ends of the brackets are not pushed into the chassis.

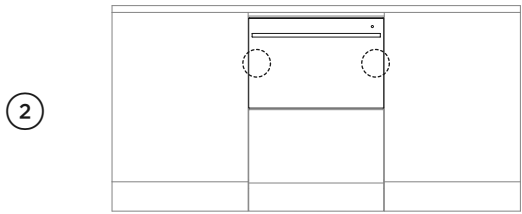

Push the product into the cavity, pulling the hoses through as you push to avoid crushing or twisting them.

Push the product in the positions illustrated to avoid denting the door.

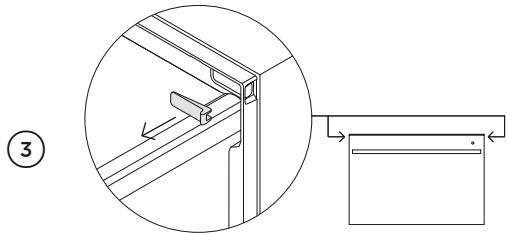

Partially open the drawer and remove the first screw cover from the trim moulding.

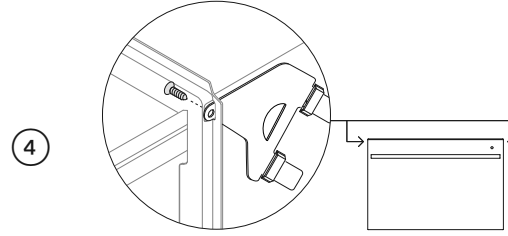

Secure to cabinetry via the brackets. Pre-drilling a pilot hole may be required depending on the cabinetry material.

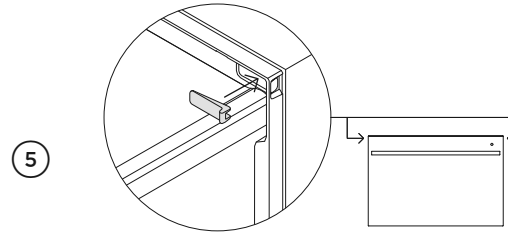

Replace the trim cover and repeat for the remaining brackets.

SECURE TO CABINETY VIA DRAWER REMOVAL (METHOD B)

1

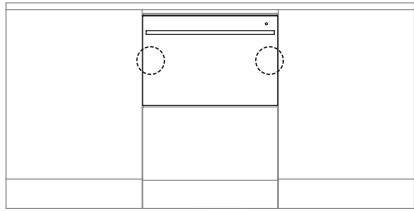

Push the product into the cavity, pulling the hoses through as you push to avoid crushing or twisting them.

Push the product in the positions illustrated to avoid denting the door.

2

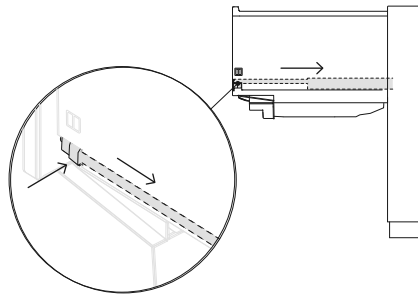

Open the drawer and press both locking tabs back to release.

3

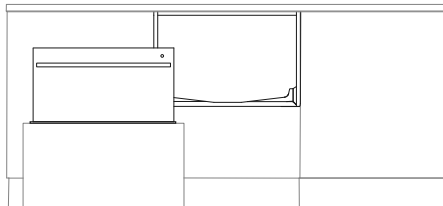

Lift the drawer off the runners and carefully set aside on a protected surface. Push runners back in.

Take care not to pull drawer out too far to prevent any strain on the hoses. Where possible, protect the base of the tub to prevent damage.

4

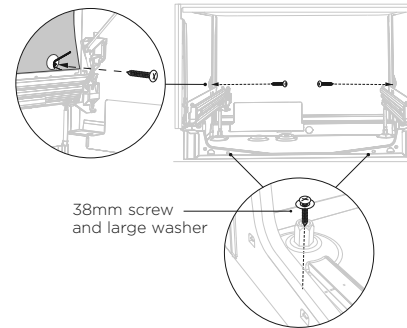

Secure to cabinetry via all three fixing locations in the chassis.

Ensure sound insulation is replaced correctly.

5

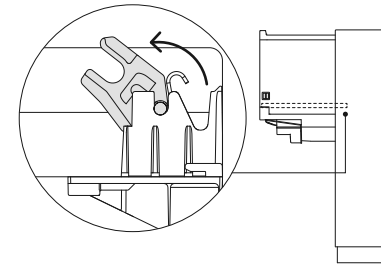

Before refitting the drawer, ensure the hoses are not twisted.

Refit the drawer to the runners and clip into place via both locking tabs.

Ø38MM STANDPIPE INSTALLATION

1

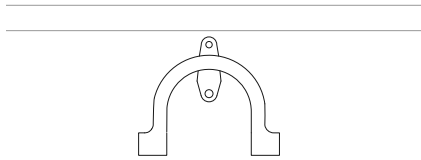

Install the drain hose support to the back wall, as close to the underside of the countertop as possible. Refer to 'Plumbing & electrical considerations' for minimum install heights.

2

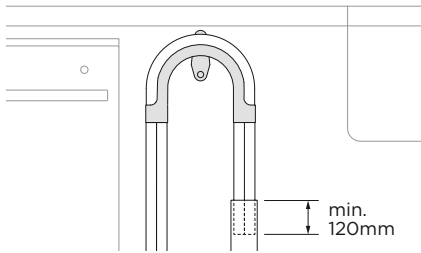

Pull the hose through the support guide and rest in standpipe. Ensure the drain hose does not extend into water retained in the trap; an air gap is required to prevent waste water from siphoning back into the tub.

3

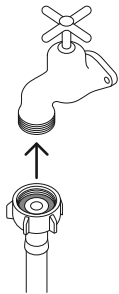

Ensure the supplied rubber washer is fitted to the coupling before connecting the inlet hose to tap. Hand-tighten into place. Using a spanner or pliers, turn a further 180° to secure. Avoiding over-tightening. **Do not turn water supply on. The DishDrawer™ Dishwasher must be powered on for the flood protection feature to be enabled.**

4

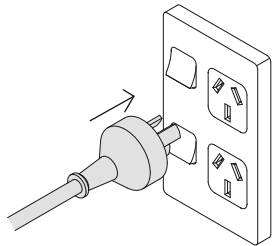

Plug product in.

SINK TRAP/WASTE TEE INSTALLATION

1

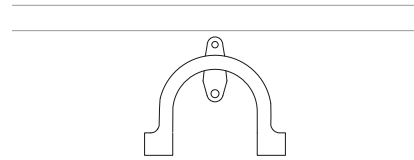

Install the drain hose support to the back wall, as close to the underside of the countertop as possible. Refer to 'Plumbing & electrical considerations' for minimum install heights.

2

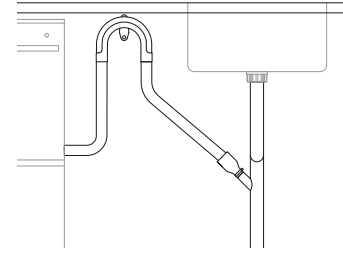

Pull the hose through the drain hose support before threading the wire clip on to the hose and fitting to the supplied hose joiner. Secure using the wire clips. Ensure hose is routed straight to the joiner, removing excess drain hose if necessary. Do not shorten the inlet hose. Unplug or drill out the waste tee before securing joiner to sink trap or waste tee.

3

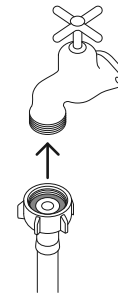

Ensure the supplied rubber washer is fitted to the coupling before connecting the inlet hose to tap. Hand-tighten into place. Using a spanner or pliers, turn a further 180° to secure. Avoiding over-tightening. **Do not turn water supply on. The DishDrawer™ Dishwasher must be powered on for the flood protection feature to be enabled.**

4

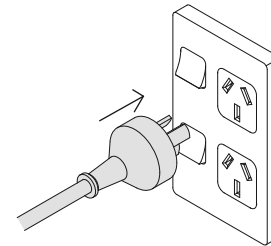

Plug product in.

INSTALLER CHECKLIST

TO BE COMPLETED BY THE INSTALLER

Installation

- Check all parts are installed correctly and are secure.
- Ensure DishDrawer™ Dishwasher is securely fastened to the cabinetry and drawer opens and closes freely with no resistance.
- Ensure any packaging or tape securing the racks and spray arm is removed.
- Check the spray arm is in place, mounted correctly and rotate freely.

Plumbing

- Ensure any knock-outs or plugs in drain connection have been drilled out and drain connection has been made.
- The drain hose joiner must not support the weight of excess hose material. Keep drain hose as fully extended as possible to prevent sagging. Any excess length of drain hose should be kept on the dishwasher side of the highloop.
- Ensure inlet hose has supplied rubber washer fitted, and that it's tightened.
- If connecting the drain hose to the sink trap, ensure the highloop is a minimum 150mm higher than the drain hose joiner.
- Water softener models: adjust the water softener setting from the default setting to suit the water hardness of the area. Refer to your user guide.
- Ensure water supply is turned off until power is connected and turned on. The DishDrawer™ Dishwasher must be powered on for the flood protection feature to be enabled.

Electrical





- Ensure all electrical tests have been conducted in accordance with local regulations.

Test operation

- Turn on the power and water supplies, then open the drawer. You should hear a beep and see a program indicator light up on the control panel.
- Add three cups of water into the drawer.
- Navigate to **RINSE** and start the program.
- Repeat for the other drawer.
- After the Rinse cycle has finished, ensure the dishwasher has run and drained correctly.
- Check the water supply has been shut off correctly.
- Check drainage connections for leaks.
- If site is left without power after installation is complete, ensure water supply is turned off to prevent flooding.**

TROUBLESHOOTING

DD60SA and DD60SC models

DISPLAY	POSSIBLE CAUSE	WHAT TO DO
 <p>Fast Delicate Rinse</p>	A1: Water Supply fault.	<ol style="list-style-type: none"> ① Ensure the water supply is turned on. ② Press ► once to stop the beeping, then again to clear the fault. ③ Press ► to resume the wash program.
<p>RINSE + all modifiers</p>  <p>Fast Delicate Rinse</p>	A3: Drawer cannot drain. The drainage hose may be blocked or kinked, or the connection to drainage pipe may be blocked.	<ol style="list-style-type: none"> ① Ensure the drainage hose and connection to pipes are not blocked. ② Press ► once to stop the beeping, then again to clear the fault. ③ Press ► to resume the wash program.
<p>DELICATE, RINSE + all modifiers</p>  <p>Fast Delicate Rinse</p>	A6: The spray arm has loosened or come off its mounting, or water pressure is too low, or a combination of low water pressure and excessive foaming.	<ol style="list-style-type: none"> ① Open the drawer and check the spray arm. ② If the spray arm has loosened or come off its mounting, re-fit it. Check that it is firmly seated and turns freely. Refer to 'Maintenance' in your user guide. ③ Press ► once to stop the beeping, then again to clear the fault. ④ Press ► to resume the wash program.
<p>FAST, DELICATE + all modifiers</p>  <p>Fast Delicate Rinse</p>		

DD60SD models

DISPLAY	POSSIBLE CAUSE	WHAT TO DO
A1	Water supply fault.	<ol style="list-style-type: none"> ① Ensure the water supply is turned on. ② Press ❶ once to stop the beeping, then again to clear the fault. ③ Press ►II to resume the wash program.
A3	Drawer cannot drain. The drainage hose may be blocked or kinked, or the connection to drainage pipe may be blocked.	<ol style="list-style-type: none"> ① Ensure the drainage hose and connection to pipes are not blocked. ② Press ❶ once to stop the beeping, then again to clear the fault. ③ Press ►II to resume the wash program.
A6	The spray arm has loosened or come off its mounting, or water pressure is too low.	<ol style="list-style-type: none"> ① Open the drawer and check the spray arm. ② If the spray arm has loosened or come off its mounting, re-fit it. Check that it is firmly seated and turns freely. Refer to 'Maintenance' in your user guide. ③ Press ❶ once to stop the beeping, then again to clear the fault. ④ Press ►II to resume the wash program.

The DishDrawer is beeping continuously

- Refer to the 'Fault codes' section of your User guide

No program indicator lights up when the drawer is opened

- Ensure power is connected and is switched on.
- **AUTO POWER-ON** may need to be activated. Refer to your User guide for details.

Drawer doesn't close properly

- Ensure nothing is obstructing the drawer from closing such as hoses or drawer latches.

Water appears around water supply and drain connections

- Check hoses, connections and existing plumbing for leaks.
- Check rubber washer and hose clamp are correctly fitted.

Product is tipping

- Ensure the product is secured to the cabinetry.

Front panels are misaligned to surrounding cabinetry

- Check the cabinetry is square. Unscrew the product from the cabinetry. Refer to page 12 for guidance. Re-secure to the cabinetry.

If a problem occurs that is not listed, refer to your user guide for additional troubleshooting. If after checking these points, you still need assistance, please refer to the Service & Warranty book for warranty details or contact us through our website fisherpaykel.com

FISHERPAYKEL.COM

© Fisher & Paykel Appliances 2021. All rights reserved.

The models shown in this guide may not be available in all markets
and are subject to change at any time.

The product specifications in this guide apply to the specific products and
models described at the date of issue. Under our policy of continuous product
improvement, these specifications may change at any time.

For current details about model and specification availability in your country,
please go to our website or contact your local Fisher & Paykel dealer.

592326A 07.21