

# Series 7, Contemporary Tall Double DishDrawer Dishwasher

Contemporary



Wash one drawer while you load the other, with room in each drawer for full-size dinner plates.

- Designed to be installed under your benchtop, with recessed handles for a seamless look
- Six wash programs, as well as additional Quick wash, Sanitize and Dry+ modifiers
- Flexible racking allows you to customize internal shelves to suit your needs

- Wi-Fi enabled and works with the SmartHQ™ app for remote control and notifications

## DIMENSIONS

Height	34 - 36 3/8 "
Width	23 9/16 "
Depth	22 9/16 "

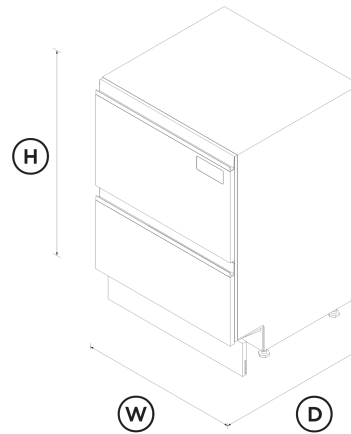

## FEATURES & BENEFITS

### Seamless Fit

Our built-under DishDrawer™ Dishwashers are installed flush under your benchtop with the option of a custom kickstrip, ensuring minimal gaps. Designed to match the Fisher & Paykel family of kitchen appliances with recessed handles for a streamlined look.

### Ease Of Use

DishDrawer™ Dishwashers are as easy to open and close as kitchen drawers and can be conveniently positioned at bench height for ease of loading and minimal bending. Flexible racking allows you to make adjustments to fit in a variety of dishes.

### Quick, Sanitize And Dry+ Options

The Quick wash modifier delivers a faster wash while maintaining performance. The Sanitize option provides extra protection, killing 99.9% of bacteria\* in the final rinse. The Dry+ setting is perfect for plastic dishes.

### True Half Load

Each drawer holds a true half load for small, fast washing that won't waste water. Both drawers operate independently so two wash cycles can operate simultaneously to allow for varying loads.

### Independent Wash

With the ability to use both drawers independently and select different wash programs, the DishDrawer™ Dishwasher can wash everything from fine glass and crystal to heavily soiled pots and pans.

### Quiet Performer

Running at a very low decibel rating, these DishDrawer™ Dishwashers do their job without making a fuss. The combination of intelligent technology and simple mechanics means greater reliability and excellent wash performance.

### Efficient Performance

Our DishDrawer™ Dishwashers use the energy they need without compromising on wash performance.

## SPECIFICATIONS

### Accessories (included)

Cutlery basket	•
Kickstrip	<b>true</b>
Knife clip and multipurpose clip	•

**Capacity and loading**

Accommodates round plates up to	<b>12.25" (top) 11" (bottom)</b>
Adjustable height, foldable cupracks	•
Fold down tines	•
Pitch adjustable tines	•
Place settings	<b>14</b>
Place settings	<b>14</b>
Place settings per drawer	<b>7</b>
Place settings per drawer	<b>7</b>

**Connected Features**

Alerts and notifications	•
Education and onboarding	•
Monitoring	•
Software updates	•

**Consumption**

Energy usage	<b>265kWh/year</b>
In-use energy carbon emissions estimate	<b>93.5kgCO2e/year</b>
Water usage (per wash cycle)	<b>3.44 gal running both tubs</b>

**Controls**

End of cycle beeps	•
Energy saving delay start option of up to 12 hours	•
Keylock	•
Smart appliance	•

**Features**

Fan assisted drying	•
Flood protection	•
Flow through detergent dispenser	•
Motor type	<b>BLDC</b>
Quiet operation	•
SmartDrive™ technology	•

**Performance**

Noise on standard cycle top drawer	<b>42 dBA</b>
------------------------------------	---------------

**Power Requirements**

Amperage	<b>10A</b>
Supply frequency	<b>60Hz</b>
Supply voltage	<b>100 - 120V</b>

**Product Dimensions**

Depth	<b>22 9/16 "</b>
Height	<b>34 - 36 3/8 "</b>
Width	<b>23 9/16 "</b>

**Wash Program Modifiers**

Dry +	•
Quick	•
Sanitise	•
Wash modifiers	<b>3</b>

**Wash Programs**

60 min	•
Eco	•
Glassware	•
Heavy	•
Light	•
Medium	•
Rinse	•
Wash programs	<b>7</b>

**Water connection**

Supplied hose to suit 3/8" (9mm) male compression fitting	•
Water pressure	<b>30kPa - 1000 kPa</b>
Water supply	<b>3/4" BSP (20mm) Connector Water Inlet Hose</b>

SKU	<b>82900</b>
-----	--------------

The product dimensions and specifications in this page apply to the specific product and model. Under our policy of continuous improvement, these dimensions and specifications may change at any time. You should therefore check with Fisher & Paykel's Customer Care Centre to ensure this page correctly describes the model currently available. © Fisher & Paykel Appliances Ltd 2020

Our In-use Energy Carbon Emissions Estimate is designed to assist customers in making informed purchasing decisions when comparing different Fisher & Paykel products. For example, a heat pump dryer typically has a lower In-use Energy Carbon Emissions Estimate than a vented dryer.



**A PEACE OF MIND SALE**  
24 Hours 7 Days a Week Customer Support

T 1.888.936.7872 W [www.fisherpaykel.com](http://www.fisherpaykel.com)

Other product downloads available at [fisherpaykel.com](http://fisherpaykel.com)

- [↓ DXF](#)
- [↓ DWG](#)
- [↓ Energy Label \(English, Canadian French\)](#)
- [↓ First Use \(English\)](#)
- [↓ First Use \(Canadian French\)](#)
- [↓ First Use \(Spanish\)](#)
- [↓ Installation Guide \(English\)](#)
- [↓ Installation Guide \(Spanish\)](#)
- [↓ California Warning Proposition 65 \(English, Spanish, Canadian French, Chinese\)](#)
- [↓ Revit](#)
- [↓ Rhino](#)
- [↓ Right To Repair Declaration \(English, Canadian French\)](#)
- [↓ SketchUp](#)
- [↓ User Guide \(English\)](#)
- [↓ User Guide \(Canadian French\)](#)

**Where applicable:**

All appliances use energy, and energy usage typically generates carbon emissions. **Fisher & Paykel Appliances' In-use Energy Carbon Emissions Estimate** indicates carbon emissions from a product's in-use energy. This is calculated either annually or per cycle, using the product's market-specific energy label energy consumption data multiplied by the carbon emissions factor for energy in your country or region.