

# Freestanding French Door Refrigerator Freezer, 32", 17 cu ft

Series 7 | contemporary

Stainless Steel | French hinge

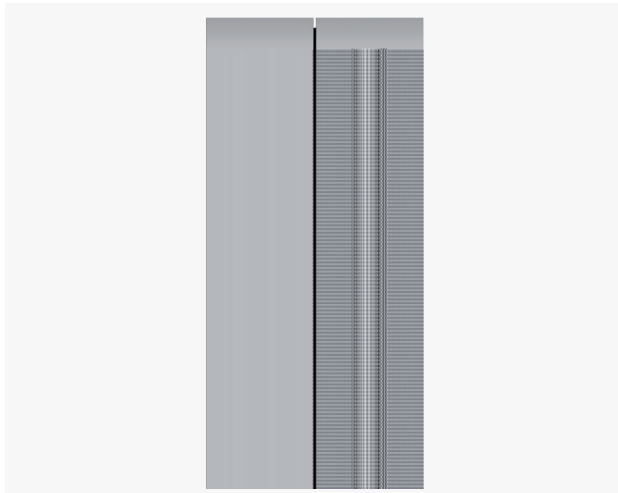

Designed for those who need plenty of flexible space for their cold and frozen food storage, with a stylish stainless steel finish.

- ActiveSmart™ technology helps keep food fresher for longer by constantly maintaining the ideal temperature
- Spacious bottom freezer with full extension drawer gives easy access to frozen goods

## DIMENSIONS

Height	67 <sup>17</sup> / <sub>32</sub> "
Width	31 <sup>3</sup> / <sub>32</sub> "
Depth	27 <sup>3</sup> / <sub>8</sub> "

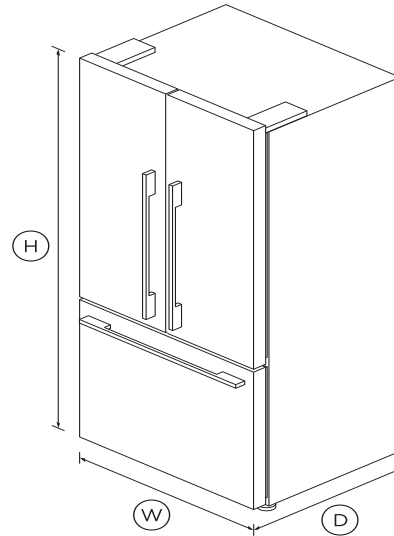

## FEATURES & BENEFITS

### ActiveSmart™ Foodcare

ActiveSmart™ technology understands that the refrigerator door is the most opened in the house. It constantly adjust temperature, airflow and humidity, maintaining an optimum environment and helping keep food fresher for longer.

### Design quality

Our refrigerators are designed and built using quality materials. We use real stainless steel on our refrigerators and solid glass for shelving.

### Easy cleaning

No more permanent dirty marks with our EZKleen feature for stainless steel refrigerators. Anti-fingerprint coating means you simply wipe clean any marks. Spill-safe secure glass shelves easily capture any drips or leaks.

### Clever energy

Your refrigerator adapts to daily use by cooling and defrosting only when needed. This means your refrigerator uses the energy it needs without compromising on food care.

### Complementary Design

With their premium handle styling and stainless steel finish, our refrigerators are designed to match the rest of Fisher & Paykel's kitchen appliance family.

## SPECIFICATIONS

### Accessories (sold separately)

Contemporary round handle kit	Part number 25376
-------------------------------	-------------------

### Capacity

Freezer	4.8cu ft
Refrigerator	12.1cu ft

### Consumption

Energy usage	501kWh/year
--------------	-------------

### Freezer features

Bottle chill	•
Fast freeze	•
Ice tray	1
Ice trays	1
Large plastic bin	•

Small plastic bins **2**

SKU **25066**

**Performance**

- ActiveSmart™ Foodcare •
- ActiveSmart™ technology •
- Adaptive defrost •
- Frost free freezer •
- Humidity control system •
- Sabbath mode •

The product dimensions and specifications in this page apply to the specific product and model. Under our policy of continuous improvement, these dimensions and specifications may change at any time. You should therefore check with Fisher & Paykel's Customer Care Centre to ensure this page correctly describes the model currently available. © Fisher & Paykel Appliances Ltd 2019.

**Product dimensions**

Depth **27 <sup>3</sup>/<sub>8</sub> "**  
 Height **67 <sup>17</sup>/<sub>32</sub> "**  
 Minimum air clearance - at rear **1-<sup>3</sup>/<sub>16</sub>" "**  
 Minimum air clearance - each **<sup>13</sup>/<sub>16</sub>" "**  
 Width **31 <sup>3</sup>/<sub>32</sub> "**





**Refrigerator features**

Adjustable door shelves **6**  
 Adjustable glass shelves **3**  
 Covered door shelves **2**  
 Door alarm •  
 Fruit and vegetable bins **2**  
 SmartTouch control panel •  
 Stackable bottle holders **4**

**Warranty**

Parts and labor **2 years**  
 Sealed system parts only **5 years**

**Other product downloads available at fisherpaykel.com**

-  [User Guide](#)
-  [Service & Warranty Booklet](#)
-  [Installation Guide](#)
-  [Installation Guide \(Quick Reference\)](#)
-  [Resources \(zip\)](#)



**A PEACE OF MIND SALE**  
**24 Hours 7 Days a Week Customer Support**  
**T 1300 650 590 W www.fisherpaykel.com**