

FISHER & PAYKEL

CLEANSMART™ CLOTHES WASHER

WL1068P model

INSTALLATION GUIDE / USER GUIDE

NZ AU

CONTENTS

Safety and warnings	4
Installation instructions	6
Before your first wash	12
Safety features	13
Control panel	14
Wash cycles	17
The CleanSmart™ wash	19
Wash preparation	20
Getting started quickly	23
Wash options	25
Customising a wash cycle	29
Changing pre-set options	31
Caring for your washer	37
Before you call for service	40
Fault codes	42
Troubleshooting	43
Manufacturer's warranty	48
Customer care	50

Registration

To register your product visit our website: fisherpaykel.com/register

⚠ WARNING!



Electrical Shock Hazard

Failure to follow this advice may result in electrical shock or death.

- If you are using an extension cord or a portable electrical outlet device (eg multi-socket outlet box), ensure that it is positioned so that it does not come into contact with water or moisture.

READ AND SAVE THIS GUIDE

When using your clothes washer, follow basic precautions, including the following:

General

- This product has been designed for personal, family or household use. This product is not designed for any commercial use. Any commercial use will terminate this products manufacturer's warranty.
- A damaged power cord must be replaced by a Fisher & Paykel trained and supported service technician or similarly qualified person in order to avoid a hazard. Do not use the appliance until it has been repaired to avoid a risk of electric shock.
- Do not operate this machine if it has been damaged during transport. Contact your Fisher & Paykel dealer or Fisher & Paykel trained and supported service technician.
- This clothes washer is not intended for use by persons (including children) with reduced physical, sensory or mental capabilities, or lack of experience and knowledge, unless they are supervised or given instructions on how to use the washer by someone responsible for their safety.
- Keep children away from the washer while it is in operation.
- Supervise children to ensure they do not play with the washer or climb inside the drum.
- The washer should only be used for washing and rinsing of textiles where this is indicated on the care label.
- Do not add petrol, dry-cleaning solvents, or other flammable or explosive substances to the wash water. These substances give off vapours that could ignite or explode.
- Do not wash articles that have been previously cleaned in, washed in, soaked in, or spotted with gasoline, dry-cleaning solvents, or other flammable or explosive substances as they give off vapours that could ignite or explode.
- The lid will be locked for some parts of the wash cycle for safety reasons. It is possible to open the lid during the cycle under certain conditions. Never force the lid open.
- Do not touch or operate the machine with wet hands or with bare-feet.
- Ensure the installation provides accessibility to the plug or incorporate a switch in the fixed wiring in accordance with the wiring rules to allow disconnection of the appliance from the supply after installation.
- Read and follow the detergent manufacturers' instructions carefully. Instructions on how to use the detergent will be clearly indicated on the pack. Remember to store your detergents out of the reach of children.

SAFETY AND WARNINGS

MODEL CODE	MAX CAPACITY* (KG)
WL1068P	10

*Capacity refers to the maximum dry weight of items the washer can wash at any one time.

- Do not overload your washing machine beyond its rated capacity.
- Do not wash an electric blanket in your washer unless the care label specifically states it is safe to do so.
- Do not wash curtains in this washer, as sunlight makes them brittle and they may disintegrate during washing.
- The only user-removable parts of the washer are the inlet hose(s) and the dispenser funnels (tops). No other parts are designed to be removed by anyone other than a Fisher & Paykel trained and supported service technician.

Installation

- For guidance on how to install your product, please refer to installation instructions contained in this document.

Water supply requirements:

- Inlet water static pressure: Max. 1MPa (145psi), Min. 34kPa (5psi)
- Inlet water flow rate at tap: Min. 8 litres/min
- A pressure-reducing valve must be installed if pressure is higher than 1MPa.
- For optimum wash performance check the supply pressure is within the recommended range.
- New hose sets provided with the washer should be used to connect the washer to the water mains. Old hose sets should not be re-used.
- We recommend the inlet hose(s) are changed every 5 years. WARNING: Failure to do so may result in a flood and damage to property.
- The hot water temperature should not exceed 65°C and the cold water temperature not exceed 35°C. Temperatures above these may cause the machine to fault or cause damage to the machine.
- Install the machine on a solid and level floor surface ensuring it has at least 20 mm clearance on each side. The washer must not be installed on any textured floor coverings (eg carpet, rugs).

Disposal

- When disposing of the washer, it is recommended that the lid is removed to avoid children getting trapped inside, and that the electrical cable is cut off close to the washer.

INSTALLATION INSTRUCTIONS

Accessories

Check if you received the following accessories with your Fisher & Paykel washer. You will find them inside the drum or attached to the packaging.

- 2 x inlet hose(s)
- 1 x drain hose guide

Unpacking

To ensure the best performance from your new washer please follow the instructions below.

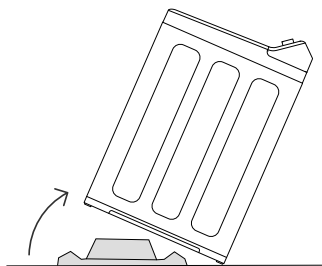

Removing the packaging

- ① Remove the outer packaging.
- ② Tilt the machine backwards and walk it off the base packer one foot at a time (ensure the lid is still taped down).
- ③ Remove the base packer from under the machine by pulling it out the front.
- ④ Remove the tape, lift the lid and remove the bowl packer from the bowl.
- ⑤ Remove the hoses and accessories.
- ⑥ Keep the base packer and bowl packer in case they are required for future transit.

Ensure that the base packer has been removed before operating your machine.

INSTALLATION INSTRUCTIONS

Product dimensions

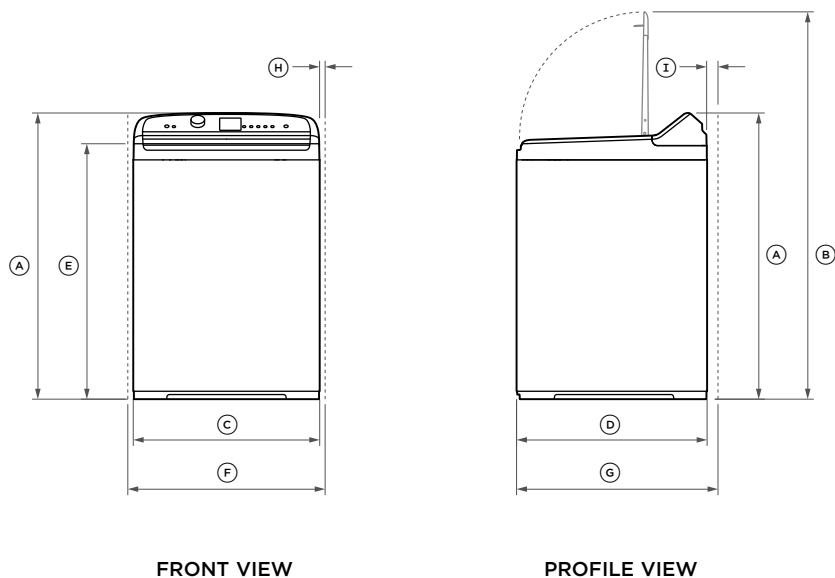

FRONT VIEW

PROFILE VIEW

PRODUCT DIMENSIONS	MM
Ⓐ Overall height of product (to highest point on console)	1060-1090
Ⓑ Overall height of product lid open	1440-1470
Ⓒ Overall width of product	685
Ⓓ Overall depth of product	700
Ⓔ Height of product to top of lid closed* (measured at front of product)	950-980
Standpipe or spigot height	850-1200
MINIMUM CLEARANCES	MM
Ⓕ Minimum cavity width	725
Ⓖ Minimum depth clearance (incl. inlet hoses and drain hose)	750
Ⓗ Minimum clearance to wall or adjacent product#	20
Ⓘ Minimum clearance at the rear of the product	50

*The exact height of your washer is dependent on how far the feet are extended from the base of the washer.

#Applies either side.

INSTALLATION INSTRUCTIONS

Levelling instructions

It is **IMPORTANT** to level the washer to ensure good spin performance.

A level is provided with your washer. The washer is level when the bubble sits in the centre, within the two lines.

Your washer is equipped with self-locking feet at the front to ensure they do not move once you have levelled your washer. Move the washer using the top corners, do not push the centre front of the washer.

After levelling, the corners of the washer should be clear of the floor and the washer must not rock in any direction.

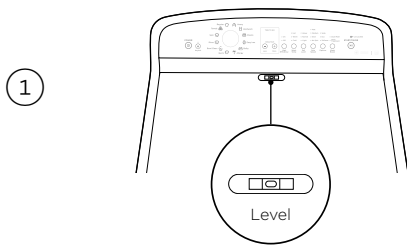

Level the washer side to side:

Close the lid and place the level at the centre back of the lid (near the control panel). Pull the machine out and adjust the rear feet until the machine is level side to side.

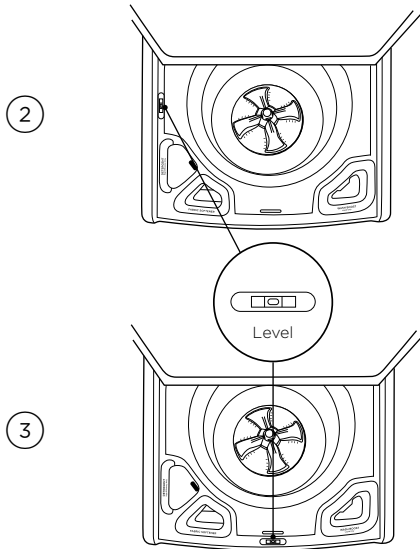

Level the washer front to back:

- Open the lid and place the level on the left side, in line with the centre of the bowl.
- Adjust the front left foot (wind down).
- Repeat the above steps for the right foot. There should be equal weight on both front feet.

Re-check the washer is level:

- Place the level at the centre front of the topdeck (forward of the lid lock slot)
- Ensure washer does not rock in any direction.
- If washer is not level repeat the above steps

If moving or transporting your washer in the future, ensure you tape the lid down.

INSTALLATION INSTRUCTIONS

Water supply

Inlet hoses

Failure to adhere to the following instructions may result in a flood and damage to property:

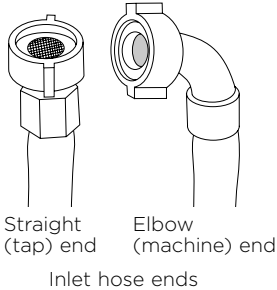

- ① Connect the straight ends of the inlet hoses to the taps (there are washers fitted in both ends). Connect the red connector hose to Hot, and the white connector hose to Cold.
- ② Connect the elbow ends of the inlet hoses to the corresponding washer inlet valves. Inlet valves are marked on the back of the washer. Ensure the Hot valve is connected to the hot tap and the Cold valve is connected to the cold tap.
H = Hot C = Cold

Only use the new hose set provided with your washer.

Water supply requirements:

- If you have an uncontrolled water heating source (eg a wet back or solar heating system) you should fit a tempering valve. This will ensure the hot water temperature remains within safe limits. Contact your registered plumber to select and install the tempering valve.
- Your cold water should not exceed 35°C and your hot water should not exceed 65°C. Temperatures above these may cause the machine to fault or cause damage to the machine.
- Inlet water static pressure: Max. 1MPa (145psi) Min. 34KPa (5psi).
- Inlet water flow rate at tap: Min. 8 litres/min.

This clothes washer should be plumbed into both a hot and cold water supply otherwise some cycles may not function correctly. Your washer does not have an internal heater to heat water.

INSTALLATION INSTRUCTIONS

Draining

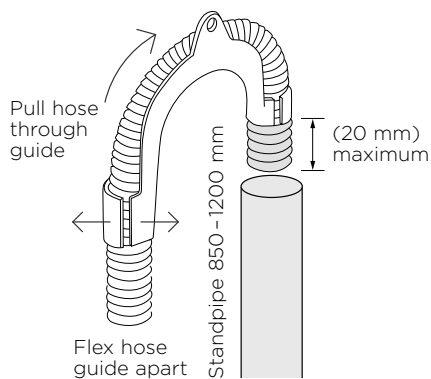

Fitting the drain hose guide

Placing the drain hose in a standpipe or tub:

- ① Carefully pull the drain hose out from the back of the washer by pulling the exposed part of the hose downward and outward.
- ② To guide the drain hose over the tub or standpipe the hose guide **MUST** be fitted to the drain hose.
- ③ Place the drain hose in the tub or standpipe. Do not fit the hose to a drain spigot. Drainage must not be airtight in order to prevent siphoning.

To prevent siphoning the drain hose should not extend more than 20 mm from the end of the guide. The height of the standpipe or tub should be between 850 - 1200 mm. The drain hose can be trimmed to length.

- Regularly check that your standpipe or tub is free from lint or other obstructions, which may affect how your washer works or may cause flooding.
- In multi-storey apartments or any upper floor, the washer should be installed on a floor equipped with a drain.
- Draining must comply with local by-laws.
- We recommend replacing the inlet hoses every 5 years. Hoses should be checked from time to time and replaced if any wear, cuts, bulges, kinks or leaks are found.

Electrical connection

- This appliance must be supplied with a 220 - 240 V, 50 Hz, sinusoidal, 10 A electrical supply.

SPARE PARTS*	PART NO.
Hose inlet long (2m)	422680P
Hose inlet large bore	426123P
Drain hose extension (not suitable for attaching to a spigot)	425627P

*Available from your Fisher & Paykel dealer or a Fisher & Paykel trained and supported service technician.

INSTALLATION INSTRUCTIONS

Completing the installation

- Turn on the water and check all hose connections for leaks. Ensure there are no kinks in the hoses. Check the hose connections for leaks again after 24 hours.
- Uncoil power cord, remove and discard the plastic pin cover, and plug into wall socket.
- Connect the appliance to an earthed outlet protected by a fuse of suitable capacity.

Installation test cycle

Your washer must be correctly installed before use. Check the installation and operation of the washer using the following procedure:

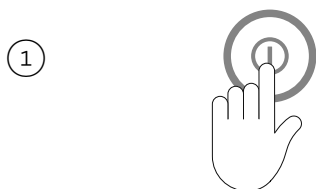

Touch **⏻** to activate your washer.

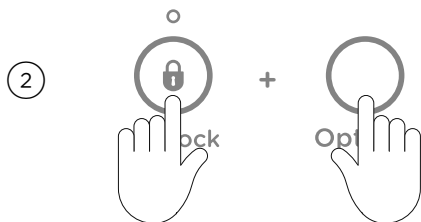

Touch both **🔒** and **OPTIONS** for 3 seconds.



Touch **▶||** to start the installation test cycle. The display will show *ln 5*.

The washer will beep to signal the end of the installation test cycle. Any faults will be displayed on the screen, refer to 'Fault Codes'.

If there are any problems, you must address these before proceeding with normal use. The washer will automatically turn off at the end of the cycle if there are no problems.

If you need further assistance, please contact a Fisher & Paykel trained and supported service technician or our Customer Care Centre.

BEFORE YOUR FIRST WASH

Check you have done everything you need to before you start your first wash:

- Has the basepacker been removed?
- Is the drain hose threaded through the hose guide 'U bend' (with no more than 20 mm extended) and hooked into your standpipe or tub, or attached to a spigot?
- Is the hot hose connected to the hot valve marked 'H'?
- Is the cold hose connected to the cold valve marked 'C'?
- Have the taps been turned on?
- Is the washer correctly levelled, feet are extended and cabinet corners are clear of the floor?
- Has the power cord been connected to an appropriate power supply and the power turned on?
- Have you performed the installation test cycle (see previous page)?

CleanSmart™ capacity

CleanSmart™ offers a very generous 10 kg capacity. The list below outlines what is included in a 10 kg wash load (in accordance with AS/NZS 2040.1:2005).

WASH LOAD - 10 KG	QUANTITY
Sheets (double)	4
Bath towels	8
Tablecloths	3
Shirts	4
T-Shirts	6
Pillowcases	6
Shorts	6
Washcloths	4
Handkerchiefs	2

The above load composition is indicative only. We recommend for everyday use that you separate out your sheets and towels and wash them separately on the **SHEETS** and **TOWELS** cycle.

SAFETY FEATURES

Lid lock

The lid of your CleanSmart™ washer is locked for some parts of the wash cycle, ensuring safety for you and your family while it is operating.

The **LID LOCKED** light (above the ►|| button) will illuminate when the lid lock is activated, letting you know if you can open the lid or not.

To unlock the lid at any time during the cycle touch ►|| .

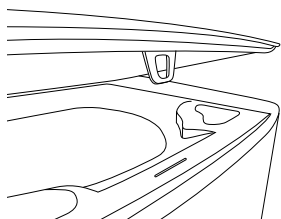

If the lid is left open, your CleanSmart™ washer will be unable to lock the lid, and the cycle will be halted. The washer will beep to alert you and display a warning message on the screen. If this occurs, ensure that the lid is closed and touch ►||.

Do not put anything down the lid lock slot in the top deck of your washer.

Do not try to disable the lid lock.

Auto drain

- Unsupervised clothes washers filled with water can present a drowning hazard to small children. In order to minimise any risk of this type of accident, your CleanSmart™ has been pre-programmed to know when this potential hazard is created and drains the wash water to a safe level.
- If you pause your CleanSmart™ at any time during the wash cycle when there is water in the bowl, the machine will activate the **AUTO DRAIN** function after 3 minutes. This will drain the water in the wash bowl to an acceptable level, minimising any potential hazard.
- A warning message *Dr* will be displayed on the digital display while **AUTO DRAIN** is in operation. The cycle can be restarted at anytime by touching ►||.

CONTROL PANEL

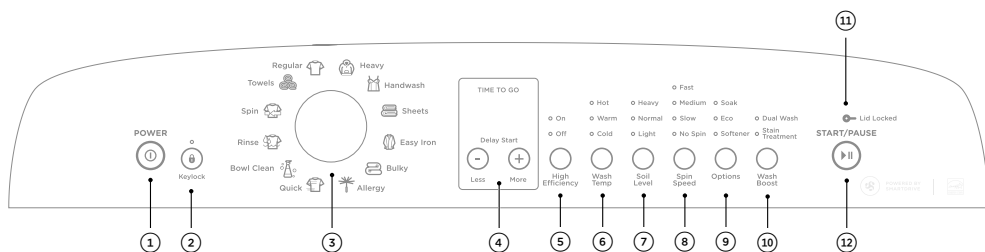

- | | |
|---------------------------------|---|
| ① POWER | Press to turn the washer ON/OFF. |
| ② Keylock | Touch for two seconds to disable all buttons on the display panel, except POWER button. This prevents accidental button presses. |
| ③ Wash Cycles | Turn the dial to select the desired cycle for your load. |
| ④ Digital display screen | Shows the following: <ul style="list-style-type: none"> • 'Time to go' – the remaining time in the cycle that is currently running. • Delayed start time of wash cycle. • Notifications if an error is detected or a warning is necessary. |
| ⑤ High Efficiency | Touch to turn High Efficiency On or Off. |
| ⑥ Wash Temp | Touch to increase or decrease water temperature. |
| ⑦ Soil Level | Touch to select the level of soil in your load |
| ⑧ Spin Speed | Touch to increase or decrease washer spin speed. |
| ⑨ Options | Touch to select Softener, Eco Rinse and Soak. |
| ⑩ Wash Boost | Touch to select Stain Treatment or Dual Wash. |
| ⑪ Lid Lock | Illuminates to indicate the lid of the washer is locked.
To open the washer pause the cycle. |
| ⑫ START/PAUSE | Touch to start or pause the selected wash cycle. |

CONTROL PANEL

Time to go

Your CleanSmart™ washer displays approximately how many minutes the cycle has remaining, so that you can tell at a glance when your washing will be finished. Once you have selected your wash cycle and options, the time the cycle will take to complete will be displayed. Please be aware that a number of factors influence the overall cycle time, eg the water flow rate and load size and cycle selection, therefore times will vary.

Keylock

Keylock can be used to lock the buttons on your CleanSmart™ when not in use. This will avoid accidental button pushes.

To turn Keylock ON or OFF:

①



Touch  for 2 seconds.

When activated, the light above the  button is illuminated.

If Keylock is ON:



①



To turn your washer on, touch  for 2 seconds. This will activate the control panel. **KEYLOCK** will remain on but let you select your wash cycle options and start the cycle.

②



To pause your washer at any time during the cycle, touch  for 2 seconds, or touch  twice in quick succession.

CONTROL PANEL

3



To stop your washer or power off at any time, touch **⏻** for 2 seconds or touch the **⏻** button twice in quick succession.

WASH CYCLES

Wash cycle guide

Your washer has a number of wash cycles to suit your laundering needs. Selecting the most appropriate cycle for each particular wash load will help ensure you get the best wash result.

CYCLE	EFFICIENCY	DESIGNED FOR	AGITATE TIME* (min)	WASH TEMP	RINSE SEQUENCE	SPIN SPEED (RPM)
Regular**	HE On	Normally soiled everyday cotton loads eg t-shirts, shorts, shirts.	11-16	Warm/ Cold	Spray/HE Deep	Fast (1100)
	HE Off	Everyday loads where extra water is an advantage eg linty, sandy or dye run is possible	11-16	Warm/ Cold	Spray/ Deep	Fast (1100)
Heavy	HE On	Heavily soiled durable garments eg tea towels, rugby shorts.	13-18	Warm	Spray/HE Deep	Fast (1100)
	HE Off	Heavily soiled durable garments when you want to use more water.	13-18	Warm	Spray/ Deep	Fast (1100)
Handwash	HE On	For delicate, lightly soiled clothes.	6	Warm/ Cold	Spray/HE Deep	Slow (330)
	HE Off	Washing delicates in more water. Also recommended for machine and hand washable woollen items.	6	Warm/ Cold	Spray/ Deep	Slow (330)
Sheets	HE On	Not available.	n/a			
	HE Off	Sheets, tablecloths, duvet/duona covers.	15	Warm	Spray/ Deep	Fast (1100)
Easy Iron	HE On	Not available.	n/a			Fast (1100)
	HE Off	Minimising creasing in your load.	11-16	Warm/ Cold	Spray/ Deep	Slow (330)
Bulky	HE On	Not available.	n/a			
	HE Off	Bulky items.	8 mins +30 min soak	Warm	2 Deep	Slow (330)
Allergy	HE On	Asthma sufferers and people with skin sensitivities.	11-16	Hot	Spray/2 HE Deep	Fast (1100)
	HE Off	Situations when a little more water is required.	11-16	Hot	Spray/ 2 Deep	Fast (1100)
Quick	HE On	Lightly soiled garments in a faster time.	9-13	Warm/ Cold	Spray/HE Deep	Fast (1100)
	HE Off	Not available.	n/a			

WASH CYCLES

CYCLE	EFFICIENCY	DESIGNED FOR	AGITATE TIME* (min)	WASH TEMP	RINSE SEQUENCE	SPIN SPEED (RPM)
Bowl Clean	n/a	For maintaining the cleanliness of your washer.	n/a	Hot	Spray/Deep	Medium (670)
	n/a		Periodic agitation during a 2hr soak			
Towels	HE On	Washing lightly soiled towels and when you want to save water.	11-16	Warm/Cold	Spray/HE Deep	Fast (1100)
	HE Off	Everyday washing of towels, new towels that may release dye during the wash, and after a day at the beach.	11-16	Warm/Cold	Spray/Deep	Fast (1100)
Rinse	HE On	Water efficient Rinse and Spin only.	None	None	Spray/HE Deep	Fast (1100)
	HE Off	Selecting Rinse and Spin only, using more water in the rinse for those situations that require it.	None	None	Spray/Deep	Fast (1100)
Spin	n/a	Selecting a Spin only. This cycle also allows you to customise the spin speed to suit your needs.	None	None	None	Fast (1100)
	n/a					

*Refers to the agitation time in the 'wash' part of the cycle, not the total time taken to complete a cycle. In addition, the actual wash time depends largely on the size of your wash load, therefore can vary by a number of minutes.

**The 'Regular' cycle, with High Efficiency ON and 'Eco' option selected, is the recommended water and energy saving cycle for normally soiled, everyday washing.

If you wish to change any of the wash options while your CleanSmart™ washer is running, touch ►|| then select the required option.

THE CLEANSMART™ WASH

The CleanSmart™ washer has two modes of washing, **HE ON (HIGH EFFICIENCY)** and **HE OFF (CONVENTIONAL)**. Both modes start the same way, with a Detergent Activating wash.

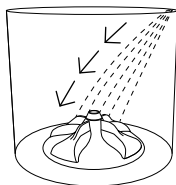

Detergent Activating wash

CleanSmart™ fills the bowl at the selected water temperature, with just enough water so the clothes are saturated. This small amount of sudsy water flows through the clothes, up a specially designed portal and back onto the clothes in a waterfall effect. This thoroughly dissolves and activates the detergent.

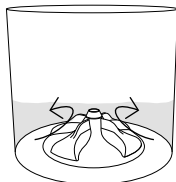

High Efficiency On (High Efficiency mode)

In the High Efficiency mode the CleanSmart™ then fills with just enough cool water to lift the clothes off the low-profile agitator so that when it rotates, the clothes gently roll over each other. This wash gives you the benefit of water savings, using similar quantities of water to most front loaders.

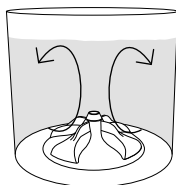

High Efficiency Off (Conventional mode)

The Conventional mode is the immersion wash all top-load washer users are familiar with. However, this mode still uses less water than that of other top loaders which utilise the immersion wash. After the Detergent Activating wash the CleanSmart™ fills with cold water until the clothes are submerged, and gently turns the clothes over. We recommend this mode when the dilution effect of water can solve or prevent common wash problems. For example, when dye or colour run can be a problem (ie new, dark-coloured garments), or when washing sandy towels.

Some cycles can be used in both modes, whilst others are available in only one.

CYCLE	HE ON	HE OFF
Regular	✓	✓
Heavy	✓	✓
Handwash	✓	✓
Sheets	-	✓
Easy Iron	-	✓
Bulky	-	✓
Allergy	✓	✓
Quick	✓	-
Towels	✓	✓

These two wash modes mean that your CleanSmart™ washer gives you the best of both worlds, accommodating any laundry situation.

WASH PREPARATION

Sorting

Sort items according to colour, fabric type, and soil type. Wash fine, delicate fabrics separately from thick, heavy fabrics. Always separate coloured items from whites, especially when they are new. Colour run could be an issue if you wash items at higher temperatures. Some soils, like mud and blood are best washed in cold water. Oily soils (eg some foods and marks on shirt collars) are best washed in warm water.

The care label will tell you about the fabric of the garment and how it should be washed.

Before you load

- Check pockets for items that could damage your clothes or get caught in the washer.
- Close zippers, hooks and eyes, and other fastenings (ie fasten the opening of duvet/ doona covers) and remove loose bra wires. All these can damage both your washer and your clothes.
- Place delicate items, such as lingerie, in a mesh laundry bag before placing in the washer.
- Pre-treat any stains, taking care not to spray pre-treaters on your washer as they can cause damage to the plastic surfaces.

Selecting the right detergent

- Your CleanSmart™ washer is a High Efficiency clothes washer and needs a low sudsing detergent to prevent over-sudsing problems. This is the same type of detergent Front Loaders use and is labelled, “Low Suds”, “Front Loader”, “High Efficiency” or “HE”.
- We recommend the use of liquid detergents in most washing situations to achieve the best results. This is particularly important when washing dark garments.
- When washing woollens use a wool detergent but use it sparingly as these are usually very high foaming.
- Do not use soap flakes or granulated soap powders.

How much detergent?

Follow the instructions stated on the back of the detergent packet as a guide to the correct amount to use. The correct amount of detergent will vary depending on the amount of soil in your clothes and the size of your load. Jeans and work clothes may need more and towels less.

- If you have over-foaming problems, reduce your dosage.
- If your clothes are not clean enough, try using a bit more.

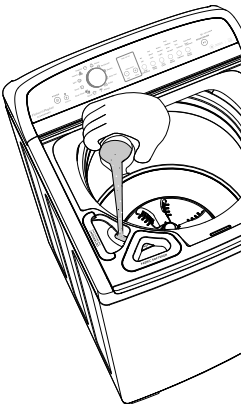

Where do I put my detergent?

Place your detergent into the detergent dispenser, located on the left side of the washer. We recommend that you measure your detergent first.

You will notice that most of the detergent placed in the dispenser will fall into the washer. It will remain in an area separated from your clothes until the washer begins to fill. As the washer fills, the dispenser will be flushed of any residue. The detergent is then mixed with water at the bottom of the washer, dissolving and activating it to ensure optimum wash performance.

WASH PREPARATION

Choosing the right cycle

If you wish to use fabric softener you will need to select **SOFTENER** by touching the **OPTIONS** button which will give you a deep rinse. If the **SOFTENER** option is not selected, the fabric softener will not be dispensed correctly.



A small volume of water remaining in the dispenser at the end of the cycle is normal.

Adding the fabric softener

Always follow the manufacturer's recommendations on the fabric softener packaging for the correct dosage. Measure the softener out into the cap and pour into the fabric softener dispenser. The softener will remain in the dispenser until the deep rinse where water flushes it into the bowl.

If you fill beyond the 'Max' mark, the fabric softener will dispense into the bowl prematurely and may stain clothes, and also contribute to scrud (described below).

If you wish to use fabric softener we recommend:

- Using it sparingly. Measure it carefully to ensure you do not fill above the 'Max' level of the dispenser.
- Using a fabric softener that is of a thinner consistency.
- Clean the dispenser as soon as the cycle has finished.
- Clean your washer regularly using the **BOWL CLEAN** cycle, refer to 'Caring for your washer'.
- Cold water washing increases the chance of this build-up occurring. We recommend a warm or hot wash at regular intervals, eg every 5th wash.

Cleaning the dispensers

The dispenser may need cleaning periodically, refer to 'Caring for your washer' for advice about cleaning the dispenser.

Scrud

Scrud is the name of the waxy build-up that can occur within any washer when fabric softener comes into contact with detergent. This build-up is not brought about by a fault in the washer. If scrud is allowed to build up in the washer it can result in stains on clothes and/or an unpleasant smell in your washer. Scrud can be kept under control by using the **BOWL CLEAN** cycle regularly, refer to 'Caring for your washer' section.

WASH PREPARATION

Wash Boost options

Your CleanSmart™ washer has an extra dispenser located on the right hand side called the Wash Boost dispenser. You can use this dispenser to boost your wash performance in two ways:

Stain Treatment

The **STAIN TREATMENT** option allows you to add a liquid in-wash fabric stain remover to help combat tough stains. The liquid treatment is released into your wash at just the right time to work on any stains present. Short soaks are included in the wash to effectively boost stain removal. For the stain remover to be dispensed correctly, ensure **STAIN TREATMENT** is selected before starting your wash.

Pre treatment products, such as concentrated spray-on fabric stain removers must NOT be used in the Wash Boost dispenser.

Dual Wash

For extra dirty loads you can perform a **DUAL WASH**. Your CleanSmart™ washer will complete a double wash; the first is an initial wash to loosen soil and get the wash started using a cool water temperature to ensure any stains are not “set in”. Detergent for this part of the wash should be placed in the detergent dispenser. The second part is a complete wash to remove all traces of dirt. The liquid detergent for this part of the wash should be placed in the Wash Boost dispenser. When you feel your load requires extra washing, ensure **DUAL WASH** is selected from the **WASH BOOST** options.

Use the manufacturer’s recommended dose of detergent in each of the detergent and Wash Boost dispensers. However, reduce the amount if you have problems with over-sudsing.

The Wash Boost dispenser is NOT designed to dispense bleach into your wash. The bleach will not be dispensed correctly and may damage your clothing. Only liquid detergent or liquid in-wash fabric stain remover must be used (ie no powder).

Adding the liquid in-wash fabric stain remover or liquid detergent

Liquid in-wash fabric stain remover, or liquid detergent only, must be used in the Wash Boost dispenser. Refer to the manufacturer’s instructions on the package for the correct dosage. Add the liquid in-wash fabric stain remover or liquid detergent to the dispenser before starting the wash cycle ensuring you do not exceed the ‘Max Level’ shown on the dispenser.

GETTING STARTED QUICKLY

The buttons require only a gentle touch to activate.

1



Touch **I** to activate your CleanSmart™ washer.

2



Select your desired wash cycle by turning the SmartTouch™ Control Dial.

3



High Efficiency

This allows you to select either a high efficiency or conventional cycle.

High Efficiency, On

To save water

High Efficiency, Off (Conventional Cycle)

To use more water when needed, refer to 'The CleanSmart™ wash'.

4

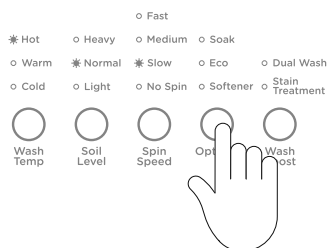

Choose your wash options, eg you may want a **WARM** wash temperature and a **SLOW** spin, refer to the 'Wash options' section.

GETTING STARTED QUICKLY

Constant interruptions to the cycle, such as touching ►|| will increase the time taken to complete the cycle and may result in poorer wash performance.

For best fabric and colour care, remove your clothes as soon as the cycle has finished.

5



Touch ►|| to start the cycle. The washer will start to fill with water and will automatically select the correct water level and wash action for your load.

6



Use 🔒 to lock the buttons on the control panel, preventing them from being activated accidentally, refer to 'The CleanSmart™ wash' section.

7

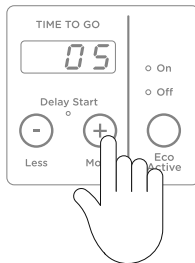

DELAY START allows you to delay the start of your wash by 5 mins up to 18 hours, refer to the 'Wash options' section.

WASH OPTIONS

Once you have selected your wash cycle you may wish to change the default wash options.

High Efficiency

This option lets you choose between a High Efficiency (ie High Efficiency On) and Conventional (ie High Efficiency Off) mode of washing. Some cycles can be used in either of the modes, or only one, depending on what is best for your clothes.

Wash Temp

Your CleanSmart™ washer offers 5 wash temperatures, and an additional setting, 'Controlled Cold'.

COLD TAP	CONTROLLED COLD	WARM/COLD	WARM	WARM/HOT	HOT
Incoming water from tap	20°C	35°C	40°C	50°C	60°C

Simply touch the **WASH TEMP** button to increase or decrease the wash temperature.

- The temperature option selected determines the temperature of the detergent activating wash (with the exception of the **ALLERGY** cycle where both parts of the wash are hot).
- Some temperatures are not available on some cycles as a safeguard for your clothes (eg **HOT** and **WARM/HOT** on the **HANDWASH** cycle).

If a hot wash is required, where both phases of the wash system are hot, you must select the **ALLERGY** cycle, or the **SHEETS** cycle and **HOT** temperature.

Controlled Cold

The temperature of cold tap water varies widely, depending on your location and the season. The lower the cold water temperature, the less effective the cold wash becomes. To help with this issue we have developed **CONTROLLED COLD** which adds a small amount of warm water, when necessary, to raise your cold water wash to approximately 20°C. This will ensure that you receive a more effective wash in cold water. Cold Tap (**ETAP**) is the default **COLD** setting on your washer. If you wish to use the **CONTROLLED COLD** setting as the default **COLD** setting, refer to 'Changing pre-set options' section to learn how to change the default setting.

Soil Level

Your clothes and other washable items sometimes need more or less cleaning than others. The **SOIL LEVEL** option lets you adjust the wash to suit the amount of soil in your load. For example, for dirty clothes, select **HEAVY** and for items that are only lightly soiled, select **LIGHT**. This adjusts the wash time accordingly to give the load the right amount of agitation in order to remove the soil.

WASH OPTIONS

Spin Speed

Your CleanSmart™ washer offers three spin speeds: **FAST** (1100 rpm), **MEDIUM** (670 rpm) and **SLOW** (330 rpm), plus an additional **NO SPIN** option.

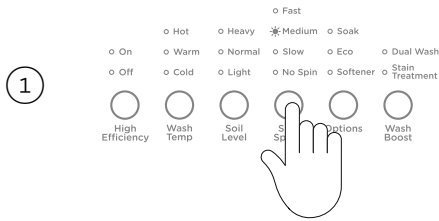

Increase or decrease your spin speed by touching the **SPIN SPEED** button. **NO SPIN** will pause the washer at the end of the rinse, allowing you to remove drip-dry items before you proceed the washer to its final spin. Touch ►|| to start the spin.

Wash Boost

If you have stains in your wash load that you need to treat or wish to perform a double wash, select **STAIN TREATMENT** or **DUAL WASH** from the **WASH BOOST** options. Refer to the 'Wash Boost options' section for detailed information on these options.

Options

Soak

The **SOAK** option provides a two hour soak during the middle of the wash phase of the cycle. The washer will then complete the rest of the cycle. During **SOAK**, the washer will agitate for a few seconds every minute.

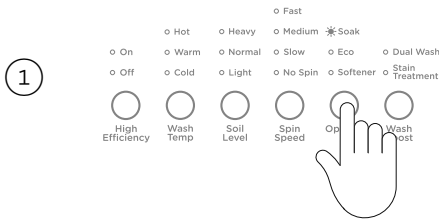

Select **SOAK** from the **OPTIONS** menu.

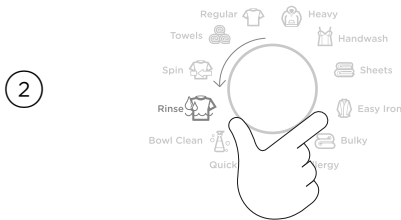

To exit **SOAK** early, touch ►|| and turn the dial to select **RINSE**.

Change the **SPIN SPEED** if necessary (eg select **SLOW** if washing handwash only, delicate, or creasable items) and touch ►||.

If the soak option is selected on a **QUICK** cycle, the soak time will only be one hour.

Ensure items are colourfast before using soak.

WASH OPTIONS

DO NOT use your washer to soak items in bleach or sanitiser and if you've soaked items in a bucket, do not tip the contents of the bucket into your washer. The chemicals in these products are very corrosive to metal surfaces and can damage your washer. Rinse and wring items out thoroughly before placing them in your washer.

Eco

Use the **ECO** option to save water. The **ECO** option uses a spray rinse which has been specially designed to use at least 25% less water than a traditional rinse. Use this option when you want to use less detergent and less water. However, if you have low water pressure or sensitive skin it is better to use a traditional rinse.

ECO option is available on selected cycles only. If **ECO** is not available for a cycle, your washer will skip over it in the **OPTIONS** menu.

Softener

If you wish to use fabric softener, ensure **SOFTENER** is selected. This will adjust the rinse part of the cycle so that softener is dispensed correctly, refer to 'Wash preparation'.

Delay Start

The **DELAY START** option can delay the start of the wash cycle between 5 minutes and 18 hours. This can be useful to time your washing to finish when you arrive home from work, or to start once you have finished in the shower.

1

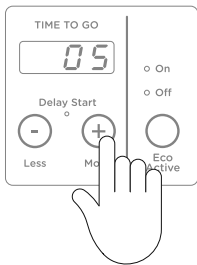

Touch **MORE +** to increase the delay time, and **LESS -** to decrease the time, or turn **DELAY START** off.

2



Touch **▶||** to confirm your selection and start the countdown. The display screen will show the time until the cycle is set to begin.

Avoid using **DELAY START** for damp, non-colourfast items as this may cause dye run to occur.

WASH OPTIONS

Clothes care safeguards

To avoid accidentally damaging your clothes there are a few options that your washer will not allow. For example you cannot select a **HOT** wash on the **HANDWASH** or **EASY IRON** cycles.

Washing bulky items

The **BULKY** cycle takes special care of bulky items. Bulky garments and bedding wash most effectively when they can move freely. Ensure that there is sufficient room in the bowl for the load to move during the wash.

When washing a single bulky item add a large beach towel to the wash, to ensure the load is balanced for an effective spin.

Bowl Clean

Cleaning the inside of your washer regularly is important. Your washer will remind you to complete a **BOWL CLEAN** cycle every 100 cycles (the **BOWL CLEAN** cycle icon will flash to alert you) or we recommend you complete this cycle 5–6 times a year, refer to the 'Caring for your washer' section.

CUSTOMISING A WASH CYCLE

To customise a cycle

You can program your CleanSmart™ washer to remember the wash options you prefer for each wash cycle. For instance, you may want to set the **TOWELS** cycle to a **WARM/HOT** wash or set the **HEAVY** cycle to include a **SOAK**.

1



Touch ① to activate your CleanSmart™ washer.

2



Turn the dial to select the wash cycle you wish to customise.

3

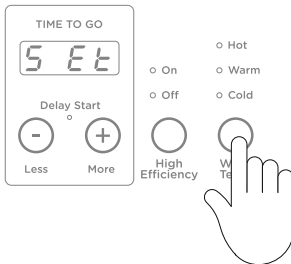

Touch the button of the option you want to customise, eg **WASH TEMP** for 3 seconds. You will hear 2 quick beeps and the wash cycle icon will flash. The screen will display **5 EE**.

CUSTOMISING A WASH CYCLE

4

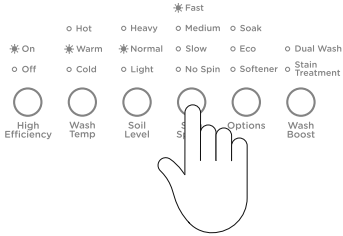

Select your preferred setting for this option, and any other options you wish to customise for this cycle.





5



Touch ▶|| to store your customised cycle. A long beep will sound to confirm that your changes have been saved.

To change your customised wash cycle simply repeat these steps.

CHANGING PRE-SET OPTIONS

ICON	DEFAULT	CUSTOMISED FUNCTION
	Heavy	Wash Temp
	Handwash	OOB Recovery
	Sheets	EOC Beeps
	Easy Iron	Factory Reset

Option Adjustment mode

After using your washer a number of times you may want to fine tune some of the options to suit your wash needs.



There are a number of pre-set options, which can be changed:

- ① The wash temperatures, including changing the **COLD** wash temperature to **CONTROLLED COLD**.
- ② The out of balance recovery routine.
- ③ The number of beeps at the end of the cycle.
- ④ Resetting to factory default settings.

To enter Option Adjustment mode:



Turn the washer on at the wall but do not touch ①.

Touch  and  together for 3 seconds. You will hear 3 quick beeps indicating you have entered Option Adjustment mode. The washer will show the default setting for the cold wash temperature.



Use the dial and buttons on the control panel to make your changes to the pre-set options.



Touch ① to return to normal mode when you have finished modifying your options. Your washer will automatically remember your changes.

To change or reset any of the options, repeat the above steps.

CHANGING PRE-SET OPTIONS

Adjusting your options



Enter the Option Adjustment mode, refer to the 'Option Adjustment mode' for instructions.

The diagram shows how the wash cycle icons relate to the pre-set options you can change. It also shows what will be displayed when you first enter Option Adjustment mode. Options you can change are accessible using the **HEAVY**, **HANDWASH**, **SHEETS** and **EASY IRON** cycles only.

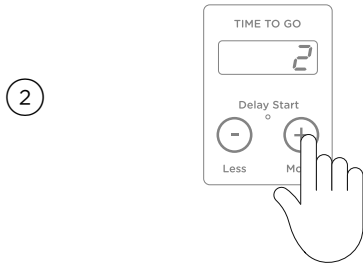

Use the **DELAY START**, **MORE +** button on the panel to scroll through the available settings of your selected option, eg to increase or decrease the temperature of your warm wash temperature, or to change the number of beeps at the end of the cycle.

Wash temperatures

All wash temperatures can be individually adjusted if you think they are too hot or too cold. The hot temperature will be the same as the hot water supply temperature.

To modify the wash temperature:



Enter the Option Adjustment mode, refer to the 'Option Adjustment mode' for instructions.

Select the **HEAVY** cycle.

CHANGING PRE-SET OPTIONS

2



Select the wash temperature you want to adjust, eg **WARM**, by touching the **WASH TEMP** button. The digital display screen shows the current setting.

3

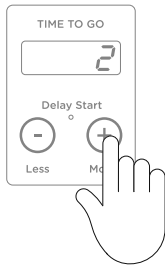

Touch **MORE +** or **LESS -** to increase or decrease to the desired temperature. Each increment is equal to approximately 0.5°C.

Controlled Cold

If your incoming cold water temperature is very low you will get a less effective wash. The **CONTROLLED COLD** option solves this problem by adding a small amount of hot water to raise the temperature of the wash to approximately 20°C.

To programme the Controlled Cold temperature option:

1



Enter the Option Adjustment mode, refer to the 'Option Adjustment mode' for instructions.

Select the **HEAVY** cycle.

CHANGING PRE-SET OPTIONS

2



Select **COLD** wash temperature by touching the **WASH TEMP** button (if not already selected).

3



The digital display shows the temperature adjustment possible. The default setting is **LAP**, ie the temperature of the incoming water from the cold water supply.

4

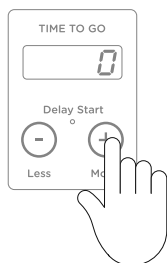

Touch the **MORE +** button until **0** is displayed. Your washer will now control the cold temperature to approximately 20°C.

Note: Each of the remaining settings equals an approximate 0.5°C temperature increase or decrease from this point.

If you always use **COLD** or **CONTROLLED COLD** water, we recommend that a **WARM** or **HOT** wash be used regularly, eg every 5th wash should be at least a warm one to maintain the cleanliness of your washer.

Out of balance recovery routine

When your washer is spinning it can sense if the wash load is out of balance. If an out of balance load is detected, the washer will stop and re-try spinning one more time. If it still senses an unbalanced load there are two options the washer can take.

Automatic recovery OFF (default setting)

Your washer will stop, beep, and show **uLl oF bRL** in three phases on the display screen. You must redistribute the load more evenly yourself and touch **▶||** to resume the cycle. Use this option if you wish to conserve water.

CHANGING PRE-SET OPTIONS

Automatic recovery ON

Your washer will try to automatically correct the out of balance load. It will fill with water and agitate to redistribute the load before trying to spin up again.

To change the out of balance (OOB) recovery routine:

1



Enter Option Adjustment mode, refer to the 'Option Adjustment mode' for instructions.

Select the **HANDWASH** cycle.

2



Touch **MORE +** to turn **AUTOMATIC RECOVERY** *on* or *off*.

End of cycle beeps

The beeps signalling the end of the cycle can be increased or decreased. The default setting is 5 beeps.

To modify the number of beeps sounding at the end of the cycle:

1



Enter Option Adjustment mode, refer to the 'Option Adjustment mode' for instructions.

Select the **SHEETS** cycle.

CHANGING PRE-SET OPTIONS

2

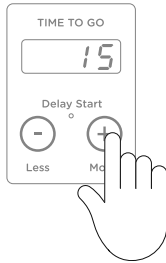

Touch **MORE +** or **LESS -** to increase or decrease the number of beeps, or for no beeps to sound at the end of the cycle.

Factory reset

You can reset your washer to the default settings it left the factory with following steps.

To reset your washer to its factory settings:

1



Enter Option Adjustment mode, refer to the 'Option Adjustment mode' for instructions

Select the **EASY IRON** cycle.

2

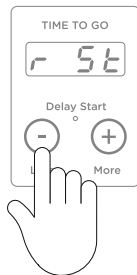

The display will show **r 5t**. Touch **▶▶** for 3 seconds to reset your washer to its factory settings.

This action will reset the washer to the default settings, exit Option Adjustment mode and restart the washer in normal operating mode.

3



Touch ⓘ to exit if you do not wish to reset your washer. To save changes and exit from the Option Adjustment mode at any time (ie to return to normal operating mode), touch ⓘ.

CARING FOR YOUR WASHER

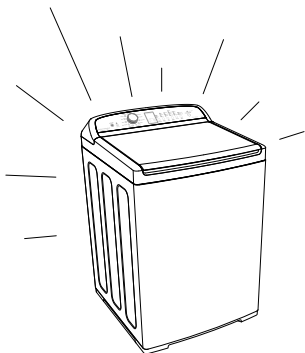

When you have finished using your washer

- Turn off the taps to prevent the chance of flooding should a hose burst.
- Unplug the machine from the power socket.

Cleaning your CleanSmart™

Before you start cleaning your CleanSmart™ washer, ensure that it is disconnected from the power (ie unplug the machine from the power socket).

Cleaning the control panel, topdeck and lid

Use a soft damp cloth to wipe all surfaces, and wipe dry. Avoid using chemical or scouring cleaners, as these will damage the paint and plastic surfaces of your washer.

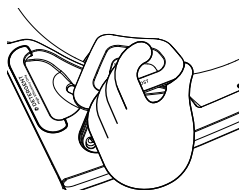

The SmartTouch™ Control Dial and soft close lid are not designed to be removable for cleaning. Do not attempt to remove the dial or lid.

Cleaning the detergent, fabric softener and wash boost dispensers

Wipe out the detergent dispenser with a damp cloth. The funnels (tops) of both the fabric softener and Wash Boost dispensers click off easily. Simply place a finger down the centre and lift. The fabric softener and Wash Boost dispenser compartments are not removable and need to be wiped clean periodically. If the siphon tube on either dispenser looks partially blocked use a cotton bud to clean.

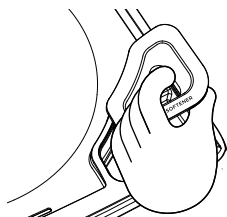

CARING FOR YOUR WASHER

Cleaning the inside of your washer

It is important that you occasionally clean the inside of your washer. Your CleanSmart™ washer has a **BOWL CLEAN** cycle specifically for this purpose and will remind you every 100 cycles to run this cycle (the **BOWL CLEAN** cycle icon will flash to alert you), or we recommend completing this cycle 5-6 times a year. We recommend the use of commercial washing machine cleaners only. Ensure the cleaner used is compatible with your waste water system, i.e. safe for use if you have a septic tank. Follow the manufacturers instructions. We suggest that you do not have any items in the washer when you run this cycle.

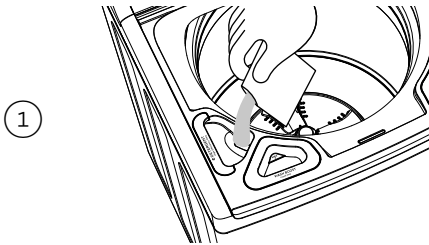

Add the washing machine cleaner directly into the detergent dispenser, follow the manufacturers instructions.

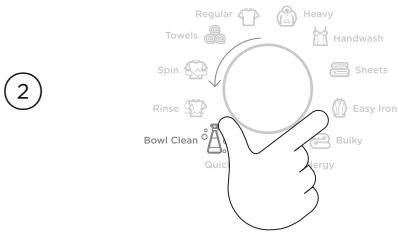

Touch **ⓘ** to turn your washer on and select the **BOWL CLEAN** cycle.



Touch **▶||** to start the cycle, refer to the 'Wash cycles' for cycle details.

CARING FOR YOUR WASHER

Cleaning your low-profile agitator

If your low-profile agitator becomes stained we recommend you use household bleach to clean it. Ensure you wear gloves. Tip a small amount of household bleach onto a soft cloth and apply to the stain. Be careful to avoid metal surfaces of your washer. Leave it to soak in for 10 minutes and repeat. Then put your CleanSmart™ washer through the **BOWL CLEAN** cycle to remove any residual bleach, refer to the 'Wash cycles' section for cycle details.

Automatic lint disposal system

With CleanSmart™ there is no need to remove messy lint filters. Your CleanSmart™ washer has a self cleaning lint disposal system. It automatically separates the lint from the wash water as it washes. The lint becomes trapped between the inner and outer bowls and is flushed out at the end of the wash.

Products that might damage your washer

- Concentrated bleaches, laundry pre-soakers/sanitiser, stain removers and hydrocarbon solvents (eg petrol and paint thinners) can cause damage to the surfaces eg control panel, and components of your washer.
- Be careful when washing garments stained with solvents as they are flammable. DO NOT put them in your dryer.
- Use of dyes in your washer may cause staining of the plastic components. The dye will not damage the washer but we suggest you thoroughly clean your washer afterwards. We do not recommend the use of dye strippers in your washer.

Saving water, energy and the environment

Water efficient washing machines will save you money, but it is also worth thinking about energy use, recycling water and the environment.

- Turn the washer off at the wall when not in use.
- Use Eco Rinse option (where available).
- Follow instructions on the detergent packet – do not overdose.
- Use concentrated detergent – it costs less per wash.
- Consider re-using the washing machine's grey water on the garden or for flushing your toilet – more information can be found on government websites promoting energy and water saving.

BEFORE YOU CALL FOR SERVICE

User warnings

Please read the following pages before you call for service.

Your washer is capable of diagnosing its own problems. If your washer gives a musical series of beeps every 5 seconds it is telling you that it has a problem which you can solve using the checklist below.

Your machine sounds a musical series of beeps* every 5 seconds and displays a user warning on the screen:

PROBLEM	DISPLAYED AS	WHAT TO DO
The washer is not getting any hot water.	n o h o t	Hot water supply is not hot enough to maintain the wash temperature you have selected. Select a lower wash temperature.
		Inlet hose filters may be blocked and should be cleaned or replaced.
		There may be a kink in the hose. Undo the hose to remove the kink, and reattach. Damaged hoses should be replaced.
		Ensure hot tap has been turned on.
The washer is not getting any cold water.	n o [L d	Check inlet hoses are connected to the correct taps.
		Ensure cold tap has been turned on.
		Inlet hose filters may be blocked and should be cleaned or replaced.
		There may be a kink in the hose. Undo the hose to remove the kink, and reattach. Damaged hoses should be replaced.
		Check inlet hoses are connected to the correct taps.
		Cold water temperature exceeds recommended limits, refer to 'Installation instructions - Water supply'.
The washer is not getting any water.	n o [R P	The flow rate of the supply water is too slow. Refer to a registered plumber for advice.
		Ensure taps have been turned on.
		Inlet hose filters may be blocked and should be cleaned or replaced.
		There may be a kink in the hose. Undo the hose to remove the kink, and reattach. Damaged hoses should be replaced.
		The drain hose is too low or the drain hose is pushed into the standpipe too far and the water is siphoning out of the washer, refer to 'Installation instructions - Draining'.
The flow rate of the supply water is too slow. Refer to a registered plumber for advice.		

*The beeps are the same sound your washer makes when you turn it on at the wall.

BEFORE YOU CALL FOR SERVICE

PROBLEM	DISPLAYED AS	WHAT TO DO
The washer is out of balance.	<p>oUt oF bAL</p>	<p>Wash load is out of balance. Ensure the washer is stationary. Manually redistribute the load.</p> <hr/> <p>Check the washer is level, refer to 'Installation instructions - Levelling instructions'.</p>
The washer has too many suds.	<p>SUD LoC</p>	<p>The washer has a suds build-up (too much detergent may have been used for the amount of soil in the load). Wait for suds to dissolve (about 20 min). Rinse clothes using a deep rinse.</p> <hr/> <p>Check the standpipe height does not exceed 1200 mm.</p> <hr/> <p>If using the DUAL WASH option, reduce the amount of detergent placed in the detergent dispenser.</p> <hr/> <p>If the symptom persists, call your Fisher & Paykel dealer or Authorised Repairer.</p>
The lid can't lock or the lid is open.	<p>Lid Lid LoC oPr</p>	<p>Make sure the lid is closed.</p> <hr/> <p>Touch ► . Refer to 'Lid lock'.</p> <hr/> <p>If the symptom persists call your Fisher & Paykel dealer or Authorised Repairer.</p>
The washer is overloaded.	<p>LoO FUL</p>	<p>The washer is overloaded and cannot agitate. Ensure the washer is stationary. Remove items until the remaining ones can move freely.</p> <hr/> <p>Check that the washer is not siphoning, refer to 'Installation instructions - Draining'.</p>
The washer has stopped.	<p>P r Cut</p>	<p>The power was cut to the washer. The washer will restart automatically. No action is required.</p>
The washer has stopped.	<p>Adr</p>	<p>The ► or ① was touched and the washer was inactive for 3 minutes. The washer will automatically drain to a safe level. Touch any button to stop autodrainage then touch ► to resume the wash cycle.</p>

FAULT CODES

If a continuous series of beeps sounds, all the lights turn off on the control panel and a number appears on the display, a fault has occurred. The washer automatically enters this mode when there is a fault. The word **FAULT** will be shown in the control panel display followed by a number (refer to example shown here). To stop the beeps, touch any button then perform the following steps:

- ① Turn your machine off at the wall.
- ② Wait for 60 seconds and turn it back on.
- ③ Check the machine is level, refer to 'Levelling instructions'.
- ④ Remove load and retry.
- ⑤ Complete a **RINSE** and **SPIN**.
- ⑥ If the fault re-occurs repeat Steps ① & ②.

If the machine still will not work call your Fisher & Paykel Dealer or Fisher & Payel trained and supported service technician to arrange service.

TROUBLESHOOTING

The following is a list of problems you may encounter when using this appliance and some suggestions that may help to correct the problem. If you still have problems, please contact your Fisher & Paykel Authorised Repairer.

Operating problems

PROBLEM	POSSIBLE CAUSES	WHAT TO DO
Washer not turning on	Power not switched on at the wall.	Switch the power on at the wall. Then touch ⓘ .
	Household power supply not working.	Try plugging in another electrical appliance.
	KEYLOCK may be activated.	Touch ⓘ for 2 seconds, refer to 'Keylock'.
Washer not filling with water when ▶ touched	Inlet taps not turned on.	Check that both the hot and cold taps are turned on.
	Blocked inlet hose filters.	Clear blockages from inlet hose filters.
	DELAY START is set.	Refer to 'Delay Start' for information.
Washer is filling continuously	Drain hose is not installed correctly.	Ensure drain hose is located in standpipe or tub. Ensure standpipe is at least 850 mm high but no more than 1200 mm high.
	Washer could be siphoning.	To prevent siphoning ensure the drain hose does not extend more than 20 mm from the end of the hose guide, refer to 'Draining'.
Washer is not spinning properly	The load could be out of balance.	Pause washer and manually redistribute the load.
	Washer is not level.	Check the washer is level and does not rock in any direction, refer to 'Levelling instructions'.
Spin speed sounds slower than normal	Clothes are unevenly distributed in the bowl.	Washer has compensated by lowering the spin speed.
	The outer wash bowl may still be hot from being filled with hot water.	The washer has slowed the spin speed as a protective measure.
Washer is continually going out of balance	Washer may not be level.	Check the washer is level and does not rock in any direction, refer to 'Levelling instructions'. Refer to 'Changing pre-set options' to change the out of balance recovery mode.
Towels causing out of balance	Heavy, wet towels have become unevenly distributed.	Try washing a mixture of large towels and smaller towels.
		Reduce the size of your load with a minimum of two towels to balance the bowl.

TROUBLESHOOTING

Operating problems

PROBLEM	POSSIBLE CAUSES	WHAT TO DO
Too much or too little water when filling	Your washer is designed to automatically sense load size and minimise water use, therefore the water level may look different to your previous washer.	This is normal.
Wash water temperature is not warm	The unique high efficiency wash system uses two wash phases. The second phase may be cooler than the first to minimise energy use.	This is normal and will not affect wash performance.
Too many soap suds	Incorrect detergent being used.	Ensure that you are using a Low Suds or HE detergent. Try using a little less detergent, especially if garments are only lightly soiled.
Your washer is making noises	Load is out of balance. There is a fault indicated by continuous beeping or a musical series of beeps.	Touch ► and redistribute the load. Refer to 'Fault codes'.
Small puddle coming from under the washer	A dispenser may be blocked.	Refer to 'Caring for your washer'

TROUBLESHOOTING

Wash problems

PROBLEM	POSSIBLE CAUSES	WHAT TO DO
Wash cycle time longer than usual	If water pressure is low, cycle time will increase due to longer fill times.	Ensure that inlet hose filters are not blocked.
	The out of balance automatic recovery setting may be selected (ie Automatic Recovery is ON).	Refer to 'Changing pre-set options'.
	Wash cycle time is approximate and may be affected by a number of factors.	Refer to 'Wash cycles'.
Small amount of water in bowl at end of cycle	A small amount of water may discharge from the fill nozzle after wash.	This is normal.
Liquid remaining in fabric softener and/or wash boost dispenser at end of cycle	SOFTENER option may not have been selected.	Check next time if you wish for softener to be dispensed that the SOFTENER option is selected.
	After flushing of dispensers, a small amount of water may remain in the dispenser at the end of the cycle.	This is normal.
	Dispensers may be blocked.	Try cleaning your fabric softener and/ or wash boost dispenser to remove any blockages, refer to 'Caring for your washer'.
Creasing	Overloading of the washer.	Try reducing load size.
	Inappropriate cycle selection.	Choose EASY IRON or HANDWASH cycle as these cycles have been designed to minimise creasing.
	Spin speed too high.	Try selecting a lower spin speed.
	Wash temperature too high for items.	Try selecting a lower wash temperature.
	Other.	Sort your load so that items of similar weight are washed together. Do not leave wet clothes to sit in the washer or laundry basket.

TROUBLESHOOTING

Wash problems

PROBLEM	POSSIBLE CAUSES	WHAT TO DO
Poor soil removal	Wash cycle selected not suited to soil level in load.	Check you are using appropriate soil level for amount of dirt.
	Warm wash water is too cold.	Refer to 'Wash Temp'.
	Not enough detergent for load size or amount of soil.	Refer to 'Wash preparation'. Try using one of the WASH BOOST options, refer to 'Wash Boost'.
	White clothes are better washed separately.	Separate light and heavily soiled items, as clothes can pick up soil from dirty wash water.
	Cold water wash is too cold.	Refer to 'Wash Temp'.
	Blood and mud are better washed in cold water, while oily soils are better washed in warmer water.	Select the wash temperature according to soil type.
	Overloading the washer.	Try reducing your load size.
	Hard water requires more detergent than soft water.	If you have hard water, try adding more detergent. Try selecting HEAVY option using the soil level button.
	Other.	Loads made up of articles of varying sizes will wash better.
Tangling	Incorrect loading.	Place items, especially sheets, in the bowl as loose parcels.
	Wash cycle selected not suited to load.	Try using EASY IRON cycle to wash shirts. Wash sheets separately using the SHEETS cycle. Wash your most valued items using the HANDWASH cycle. Try using HIGH EFFICIENCY OFF , refer to 'High Efficiency'.
Linting	Some items in load more likely to release or pick up lint.	Wash lint givers (eg towels, flannelette sheets) separately from lint collectors (eg synthetic fabrics).
	Overloading the washer.	Try reducing your load size.
	Not enough detergent to hold the lint in suspension.	Try using more detergent.
	Over-drying in a dryer can cause a build-up of static electricity in synthetic fabrics and cause them to attract lint.	Try not to over dry items when using your dryer.

TROUBLESHOOTING

Wash problems

PROBLEM	POSSIBLE CAUSES	WHAT TO DO
Detergent residue	Overloading the washer.	Try reducing your load size.
	Incorrect detergent dosage.	Try using less detergent.
	Cold ambient temperatures, cold washes and/or short agitation times may not allow the detergent to dissolve properly.	Check the detergent instructions. Try pre-dissolving the detergent before adding it to the washer.
	Wash cycle selected is not the most appropriate.	Try using a liquid detergent. Try using SOFTENER option to give more water in the rinse. Note: adding fabric softener is not needed in this instance.
Black or grey marks on clothes	A build up caused by the interaction of fabric softener and detergent can flake off and mark clothes.	Empty washer and put through a BOWL CLEAN cycle.
	Insufficient detergent for the amount of soil on the clothes, can result in grey marks on clothes.	Make sure you are using enough detergent for the amount of dirt in your wash load.
Dye transfer	Washing dark coloured and light coloured items together.	Remember to separate whites and colours.
	Non-colourfast clothes left sitting in a washer or laundry basket can transfer dye onto other clothes.	Wash and dry non-colourfast clothes separately.
	Non-colourfast items washed on ALLERGY cycle.	ALLERGY cycle is not appropriate for non-colourfast items.
Sheets and duvet/doona covers tangling or engulfing each other	Wash cycle selected is not the most appropriate.	Wash sheets and duvet/doona covers on their own on the SHEETS cycle.
	Incorrect loading.	Place sheets and duvet/doona covers into the bowl individually, to the side of the low profile agitator (ensure each item does not cover more than half of the bowl area). Load the items in layers around the bowl (2 sheets or duvet/doona covers per layer). Ensure duvet/doona covers are buttoned or domed closed before washing.

MANUFACTURER'S WARRANTY

For New Zealand and Australia only. You automatically receive a two-year Manufacturer's Warranty with the purchase of this clothes washer covering parts and labour for servicing within the country of purchase.

Fisher & Paykel undertakes to:

Repair or, at its option, replace without cost to the owner either for material or labour any part of the product, the serial number of which appears on the product, which is found to be defective within two years of the date of purchase.

You also receive an additional eight-year parts only Manufacturer's Warranty on your Direct Drive motor. This additional eight-year Manufacturer's Warranty commences on the day following the expiry of the two-year Manufacturer's Warranty and excludes the motor controller and labour. Fisher & Paykel will repair (as to parts) or, at its option, replace any Direct Drive motor (but not the motor controller) which is found to be defective within this additional Manufacturer's Warranty period. You will be responsible for any labour costs.

Note: These Manufacturer's Warranties are an extra benefit and do not affect your legal rights.

These Manufacturer's Warranties DO NOT cover

- Ⓐ Service calls which are not related to any defect in the product. The cost of a service call will be charged if the problem is not found to be a product fault. For example:
 - ① Correcting the installation, eg removal of bottom packer and transit bolts (front loading washers), levelling the washer, adjustment of the drain to correct siphoning, noises, crossed, kinked or leaking inlet hose connections, turning on water, noises caused by the waterhammer or power supplies.
 - ② Providing instruction on use of the product or changing the set-up of the product, eg instruction on correct use of detergents and fabric softeners.
 - ③ Replacing fuses in, or correcting house wiring or correcting house plumbing, eg unblocking drains.
 - ④ Correcting fault(s) caused by the user.
 - ⑤ Noise or vibration that is considered normal, eg spin sounds, user warning beeps.
 - ⑥ Correcting damage caused by pests, eg rats, cockroaches, etc.
 - ⑦ Water on the floor due to incorrect loading or excessive suds.
 - ⑧ Blocked pumps, removal of foreign objects/substances from the washer, including the pump and inlet hose filters, eg bra wires, bread tags, nails, grit, scrud, etc.
 - ⑨ Correcting corrosion or discolouration due to chemical attack.
- Ⓑ Defects caused by factors other than:
 - ① Normal domestic use; or
 - ② Use in accordance with the product's user guide.
- Ⓒ Defects to the product caused by accident, neglect, misuse or 'act of God'.
- Ⓓ The cost of repairs carried out other than by a Fisher & Paykel trained and supported service technician or the cost of correcting such repairs.
- Ⓔ Normal recommended maintenance as set out in the product's user guide.
- Ⓕ Repairs when the appliance has been dismantled, repaired or serviced by other than a Fisher & Paykel trained and supported service technician or the selling dealer.

MANUFACTURER'S WARRANTY

- Ⓒ Pick-up and delivery.
- Ⓗ Transportation or travelling costs involved in the repair when the product is installed outside the Fisher & Paykel trained and supported service technician's normal service area.

Nothing in this Manufacturer's Warranty is intended to, nor limits, any rights you may have under law to recover the costs of inspecting or returning the goods to us.

This product has been designed for use in a normal domestic (residential) environment. This product is not designed for any commercial use (whatsoever). Any commercial use by a customer will affect this product's Manufacturer's Warranty.

Service under these Manufacturer's Warranties must be provided by a Fisher & Paykel trained and supported service technician, refer to 'Customer care'. Such service shall be provided during normal business hours. This Manufacturer's Warranty certificate should be shown when making any claim.

For Australian customers

This Manufacturer's Warranty is an extra benefit and does not affect your legal rights. Our goods come with guarantees that cannot be excluded under the Australian Consumer Law. You are entitled to a replacement or refund for a major failure and compensation for any other reasonably foreseeable loss or damage. You are also entitled to have the goods repaired or replaced if the goods fail to be of acceptable quality and the failure does not amount to a major failure.

Keep this user guide in a safe place.

CUSTOMER CARE

Before you call for service or assistance:

Check our website, fisherpaykel.com, for 'Product Help' to see the latest updates, hints and tips, and information about your product.

We recommend that you also refer to your User guide to ensure:

- ① Your product is correctly installed.
- ② You are familiar with its normal operation.
- ③ You have read the 'Before you call for service', 'Fault codes' and 'Troubleshooting' at the back of the book.

If after checking these points you still need assistance or parts, you can go online to our website and book a service with your nearest Fisher & Paykel trained and supported service technician. Our Customer Care team is also available to offer you assistance.

In New Zealand if you need service or assistance:

Go online to our website and book a service or call the Fisher & Paykel Customer Care Centre and talk to one of our Customer Care Consultants.

Toll Free: 0800 FP CARE or 0800 372 273

Email: customer.care@fisherpaykel.com

Website: fisherpaykel.com

Postal address: Fisher & Paykel Appliances Ltd, PO Box 58546, Botany, Auckland 2163

Fisher & Paykel has a network of Fisher & Paykel trained and supported service technicians who can carry out any service necessary on your appliance. Visit our website and book a service with a Fisher & Paykel trained and supported service technician in your area.

In Australia if you need service or assistance:

Go online to our website and book a service or call the Fisher & Paykel Customer Care Centre and talk to one of our Customer Care Consultants.

Toll Free: 1300 650 590

Email: customer.care@fisherpaykel.com

Website: fisherpaykel.com

Postal address: Fisher & Paykel Appliances Australia Pty Ltd, PO Box 798, Cleveland QLD 4163

Fisher & Paykel has a network of Fisher & Paykel trained and supported service technicians who can carry out any service necessary on your appliance.

Visit our website and book a service with a Fisher & Paykel trained and supported service technician in your area.

If you call, write to or contact us via our website, please provide your name and address, model number, serial number, date of purchase and a complete description of the problem. This information is needed in order to better respond to your request for assistance.

Product details can be found on the rear of the washing machine.

CUSTOMER CARE

Registration

Register your product with us so we can provide you with the best service possible.
To register your product visit our website: fisherpaykel.com

Complete and keep for safe reference:

Model	_____
Serial No.	_____
Purchase Date	_____
Purchaser	_____
Dealer	_____
Suburb	_____
Town	_____
Country	_____

FISHERPAYKEL.COM

© Fisher & Paykel Appliances 2021. All rights reserved.

The models shown in this guide may not be available in all markets
and are subject to change at any time.

The product specifications in this guide apply to the specific products and
models described at the date of issue. Under our policy of continuous product
improvement, these specifications may change at any time.

For current details about model and specification availability in your country,
please go to our website or contact your local Fisher & Paykel dealer.

421752C 05.21