

Induction Range, 36", 5 Zones with SmartZone, Self-cleaning

Series 9 | Professional

Stainless Steel



With intuitive touchscreen, induction cooktop and a convection oven with 15 functions, cooking on this refined range is a joy.

- Guided cooking using your touchscreen makes it simple to cook by food, function or recipe.
- Five induction cooking zones, which can be paired to form two large SmartZones
- 4.8 cu ft total oven capacity
- Beautiful LED halo-illuminated dials provide information at a glance

DIMENSIONS

Height	35 3/4" - 36 3/4"
Width	35 7/8"
Depth	29 1/8"

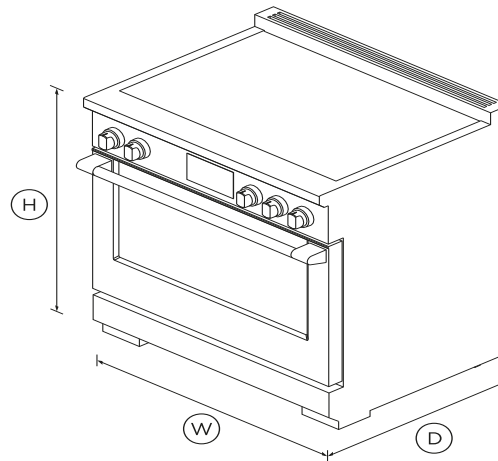

FEATURES & BENEFITS

Cook with confidence

Our touchscreen interface provides an intuitive guided cooking experience that helps deliver perfect results, whether you've been cooking all your life or just starting out. Cook with a favorite method, a hero ingredient, or a go-to cooking function or recipe. The screen tilts for improved ergonomics and optimal visibility while cooking.

Generous capacity

Featuring a large 4.8 cu ft total capacity convection oven, with

enough room to fit a 32 lb turkey and full-size baking sheets.

Cooking flexibility

No matter what you're cooking, you've got the right heat to get perfect results. Each of the 15 oven functions have been extensively researched and carefully designed to cater to a broad range of dishes and cooking styles. The handy food probe helps you monitor your progress.

Cooktop power

Instant and immediate control from the highest to the gentlest heat. The finely tuned cooktop controls let you sear, stir fry or simmer to perfection. Since most of the heat generated by the cooktop is transferred into cookware, induction offers an energy-efficient cooking option.

Design quality

This range has craftsmanship in every detail, with real stainless steel, high-quality glass, and beautifully weighted, halo illuminated dials. Each cavity features incandescent lights and full extension telescopic racks. From the robust legs to the powerful cooktop, this Range is built to last.

Easy to clean

The oven features a self-cleaning function and self-clean proof side racks, which don't need to be removed when using this function. The durable induction cooktop surface only needs a quick wipe after use to keep it clean.

SPECIFICATIONS

Accessories

Adjustable feet covers	•
Branded coin end cap	•
Square handle option	AH-R36









Capacity

Shelf positions	5
-----------------	----------

<hr/> <p>Cleaning</p> <ul style="list-style-type: none"> Pyrolytic self-clean • <hr/> <p>Controls</p> <ul style="list-style-type: none"> Dial with illuminated halo • Electric circuit 4 wire High resolution display • Metal illuminated dials • Multi-language interface • Precise cooking with food • Sabbath mode • Tilting touch screen interface • Wi-Fi connectivity • <hr/> <p>Oven features</p> <ul style="list-style-type: none"> Concealed element • Electronic oven control • Food probe • Internal light • Large broil pan • Self-clean proof side racks • True convection • <hr/> <p>Oven functions</p> <ul style="list-style-type: none"> Air fry • Bake • Classic bake • Clean • Convection Broil • 	<ul style="list-style-type: none"> Convection bake • Dehydrate • Maxi Broil • <p>Number of functions 15</p> <ul style="list-style-type: none"> Pastry bake • Pizza bake • Rapid proof • Roast • Slow cook • True convection • Warm • <hr/> <p>Oven performance</p> <ul style="list-style-type: none"> Bake power 4600 Main oven - True convection 2500W <hr/> <p>Power requirements</p> <ul style="list-style-type: none"> Rated current 50A Supply frequency 60Hz <hr/> <p>Product dimensions</p> <ul style="list-style-type: none"> Depth 29 1/8" Height 35 3/4 - 36 3/4" Width 35 7/8" <hr/> <p>Rangetop features</p> <ul style="list-style-type: none"> Dual zones • Gentle heat • Heat settings 9 Induction cooking technology • 	<ul style="list-style-type: none"> SmartZone 1 Zone bridging • <hr/> <p>Rangetop Performance</p> <ul style="list-style-type: none"> Centre 2600W Left front zone rating 2100 (3700)W Left rear zone rating 2100 (3700)W Number of cooking zones 5 PowerBoost • Right front zone rating 2100 (3700)W Right rear zone rating 2100 (3700)W <hr/> <p>Recommended Back Guards Ventilation</p> <ul style="list-style-type: none"> Combustible situation BGRV3-3036H Non combustible situation BGRV2-3036 / BGRV2-1236 Recommended hood HCB36-6_N (36" Professional) <hr/> <p>Safety</p> <ul style="list-style-type: none"> ADA compliant • Pan detection system • Safety time out • Surface hot indicators • <hr/> <p>Warranty</p> <ul style="list-style-type: none"> Parts and labor Limited 2 years <hr/> <p>SKU 81892</p> <hr/>
--	---	---

The product dimensions and specifications in this page apply to the specific product and model. Under our policy of continuous improvement, these dimensions and specifications may change at any time. You should therefore check with Fisher & Paykel's Customer Care Centre to ensure this page correctly describes the model currently available. ? Fisher & Paykel Appliances Ltd 2020

Other product downloads available at fisherpaykel.com

-  [User Guide](#)
-  [Service & Warranty](#)
-  [Installation Guide](#)
-  [Specification Guide Induction Range](#)
-  [Data Sheet Induction Range and Professional Range Backguard](#)
-  [Data Sheet Induction Range and Professional Range Backguard](#)
-  [Data Sheet Induction Range and Professional Range Backguard with Angled Vent Trim](#)
-  [Data Sheet Induction Range](#)
-  [Planning Guide Induction Range](#)



A PEACE OF MIND SALE

24 Hours 7 Days a Week Customer Support

T 1.888.936.7872 W www.fisherpaykel.com