

Double DishDrawer™ Dishwasher, Sanitise

Series 9 | Contemporary

Black Glass



Wash one drawer while you load the other, with room in each drawer for full-size dinner plates.

- Designed to be installed under your benchtop, with recessed handles for a seamless look
- Six wash programs, as well as additional Quick wash, Sanitise and Extra Dry modifiers
- Flexible racking allows you to customise internal shelves to suit your needs
- Wi-Fi enabled and works with the SmartHQ™ app for remote control and notifications

DIMENSIONS

Height	820 - 880mm
Width	599mm
Depth	573mm

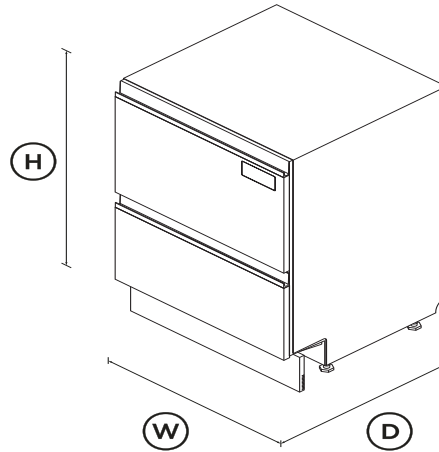

FEATURES & BENEFITS

Considered design

Designed to match our Contemporary style black glass family of products, this built-under dishwasher has a tactile matte black glass finish that pairs perfectly with recessed handles.

Seamless Fit

Our built-under DishDrawer™ Dishwashers are installed flush under your benchtop with the option of a custom kickstrip, ensuring minimal gaps.

Ease of use

DishDrawer™ Dishwashers are as easy to open and close as kitchen drawers and can be conveniently positioned at bench height for ease of loading and minimal bending. Flexible racking allows you to make adjustments to fit in a variety of dishes.

Quick, Sanitise and Extra Dry options

The Quick wash modifier delivers a faster wash while maintaining performance. The Sanitise option provides extra protection, killing 99.9% of bacteria* in the final rinse. The Extra Dry setting is perfect for plastic dishes.

Knock to pause

For ease-of-use, these DishDrawer™ Dishwashers have a knock to pause function. A knock on the front panel will pause the dishwasher, which can be restarted by using the start button.

True half load

Each drawer holds a true half load for small, fast washing that won't waste water. Both drawers operate independently so two wash cycles can operate simultaneously to allow for varying loads.

Quiet performer

Running at a very low decibel rating, these DishDrawer™ Dishwashers do their job without making a fuss. The combination of intelligent technology and simple mechanics means greater reliability and excellent wash performance.

SPECIFICATIONS

Accessories

- Cutlery basket
- Kickstrip
- Knife clip and multipurpose

Capacity and loading

Accommodates round plates **280mm**

Adjustable height, foldable	•
Fold down tines	•
Place settings	14
Place settings per drawer	7

Consumption

Energy rating	3.5 star
Energy usage	136kWh/year per drawer
In-use energy carbon	18.4kgCO2e/year per drawer
Water consumption (per wash)	6.9L per drawer
Water efficiency	4.5 star (WELS)

Controls

Energy saving delay start	•
Internal wash selector	•
Keylock	•
Knock to pause	•
Rinse aid indicator light	•
Wi-Fi connectivity	•

Features

Fan assisted drying	•
Flood protection	•
Flow through detergent	•
Motor type	BLDC
Quiet operation	•
SmartDrive™ technology	•

Performance

Noise on standard cycle top	42dBA
-----------------------------	-------

Power requirements

Amperage	10A
Supply frequency	50Hz
Supply voltage	220 - 240V

Product dimensions

Depth	573mm
Height	820 - 880mm
Width	599mm

Warranty

Parts and labour	2 years
------------------	---------

Wash Program Modifiers

Extra Dry	•
Quick	•
Sanitise	•
Wash modifiers	3

Wash Programs

Delicate	•
Eco	•
Fast	•
Heavy	•
Medium	•
Rinse	•
Wash programs	6

Water connection

Water pressure	30kPa - 1000 kPa
Water supply	3/4" BSP (20mm) Connector

SKU	82882
-----	-------

The product dimensions and specifications in this page apply to the specific product and model. Under our policy of continuous improvement, these dimensions and specifications may change at any time. You should therefore check with Fisher & Paykel's Customer Care Centre to ensure this page correctly describes the model currently available. ? Fisher & Paykel Appliances Ltd 2020

Other product downloads available at fisherpaykel.com

- [↓](#) Service & Warranty
- [↓](#) Energy Label DishDrawer™ Dishwasher
- [↓](#) User Guide DishDrawer™ Dishwasher
- [↓](#) Wash Program Data ASNZS DishDrawer™ Dishwasher
- [↓](#) Installation Guide Double DishDrawer™ Dishwasher
- [↓](#) Preliminary Specification Guide Double DishDrawer™ Dishwasher



A PEACE OF MIND SALE

24 Hours 7 Days a Week Customer Support

T 0800 372 273 W www.fisherpaykel.com