

FISHER & PAYKEL

**FRONT LOADER
WASHING MACHINE**

WH1260MZB5

**USER GUIDE
NZ AU**

CONTENTS

Safety and warnings	4
Get to know your washer	7
Control panel	8
Menu	9
First use	10
Add detergent or softener	11
Sort your items	12
Understanding fibre types	13
Load the washer	14
Set a cycle	15
Set up Auto Dose	18
More options	19
Set Delayed start	21
Save favourite cycles	22
Adjust settings	24
Wi-Fi connection and remote mode	26
Cycle selections	29
Wash temperatures and spin treatments	33
Choose a detergent	34
Clean and maintain your appliance	35
Clean the dispenser drawer	36
Run the Drum Clean cycle	37
Unlock the door	38
Clean the pump filter	39
Troubleshooting	41
Faults	44
Compliance information	45
Manufacturer's Warranty and Service Guide	46

Registration

To register your product visit our website: fisherpaykel.com/register

⚠ WARNING!



Electric Shock Hazard

Failure to follow this advice may result in electric shock or death.

- If you are using an extension cord or a portable electrical outlet device (e.g. multi-socket outlet box), ensure that it is positioned so that it does not come into contact with water or moisture.

READ AND SAVE THIS GUIDE

WARNING!

Read Safety Guide. Failure to follow all guides and rules could cause personal injury or property damage. Use this appliance only for the intended purpose as described in the user guide and installation guide of this appliance. When using this appliance, always exercise basic safety precautions including the following:

General

- This product has been designed for personal, family or household use. This product is not designed for any commercial use.
- Do not touch or operate the appliance with wet hands or with bare feet.
- A damaged power cord must be replaced by a Fisher & Paykel trained and supported service technician or similarly qualified person in order to avoid a hazard. Do not use the machine until it has been repaired to avoid a risk of electric shock.
- Do not operate this appliance if it has been damaged during transport. Contact your Fisher & Paykel dealer or Fisher & Paykel trained and supported service technician.
- This appliance is not intended for use by persons (including children) with reduced physical, sensory or mental capabilities, or lack of experience and knowledge, unless they are supervised or given instructions on how to use the appliance by someone responsible for their safety.
- Never place dripping wet clothes on top of the washer as this could create an electrical hazard.
- Keep children away from the washing machine while it is in operation.
- Supervise children to ensure they do not play with the appliance or climb inside the drum.
- Do not swing on or put weight on the door.
- Check and remove all objects from pockets, e.g. lighters and matches.
- The washing machine should only be used for washing and rinsing of textiles where this is indicated on the care label.
- Do not add petrol, dry-cleaning solvents, or other flammable or explosive substances to the wash water. These substances give off vapours that could ignite or explode.
- Do not wash articles that have been previously cleaned in, washed in, soaked in, or spotted with gasoline, dry-cleaning solvents, or other flammable or explosive substances as they give off vapours that could ignite or explode.
- The door will be locked from the start of the cycle until the cycle is complete for safety reasons. It is possible to open the door during the cycle under certain conditions. Never force the door open.

SAFETY AND WARNINGS

- Do not touch the door during a cycle as the door can become hot.
- When Sanitise and Allergy cycles are selected, the door glass will become hot. Do not touch the glass part of the door. Keep children away from the washing machine.
- Read and follow the detergent manufacturer's instructions carefully. Instructions on how to use the detergent will be clearly indicated on the pack. Remember to store your detergents out of the reach of children.
- Do not wash an electric blanket in your washing machine unless the care label specifically states it is safe to do so.
- Do not wash curtains in this washing machine, as sunlight makes them brittle and they may disintegrate during washing.
- Do not put dripping wet clothes on top of the washer as this could create an electrical hazard.
- The only user-removable parts of the washing machine are the inlet hose(s), dispenser drawer and pump filters. No other parts are designed to be removed by anyone other than a Fisher & Paykel trained and supported service technician.
- Do not overload your washing machine beyond its rated capacity.

MODEL CODE	MAXIMUM CAPACITY* (KG)
WH1260MZB5	12kg

*Capacity refers to the maximum dry weight of items the washing machine can wash at any one time

Installation

- Install the appliance on a solid and level floor surface. Ensure it has at least 12mm clearance on each side and at the top, and at least 30mm clearance at the rear.
- The appliance must not be installed on any textured floor coverings (e.g. carpet, rugs).
- This appliance can be installed on a compatible Fisher & Paykel plinth. To ensure stability, the plinth must be fitted correctly with the appliance. For installation instructions and compatible plinth models, refer to fisherpaykel.com.
- Do not install or operate this appliance on any other plinth or structure.
- Ensure the installation provides accessibility to the plug or incorporate a switch in the fixed wiring in accordance with the wiring rules to allow disconnection of the appliance from the supply after installation.
- Do not attempt to lift washer on your own as this could cause harm or injury. Always lift appliance with at least two people.
- Ensure any transit bolts have been removed before operating appliance.

Water supply requirements:

- Inlet water pressure: Max. 1MPa (145psi), Min. 50kPa (7.3psi)
- Inlet water flow rate: Min. 6 litres/minute
- A pressure-reducing valve must be installed if pressure is higher than 1MPa.
- For optimum wash performance check the supply pressure is within the recommended range.
- New hose sets provided should be used to connect the appliance to the water mains. Old hose sets should not be re-used.
- We recommend the inlet hose(s) are changed every 5 years. WARNING: Failure to do so may result in a flood and damage to property.
- The hot water temperature should not exceed 65°C and the cold water temperature should not exceed 35°C. Temperatures above these may cause the appliance to fault or cause damage to it.

SAFETY AND WARNINGS

Disposal

- When disposing of this appliance, the door should be removed to avoid children getting trapped inside, and that the electrical cable is cut off close to the cabinet.

For more detailed information and comprehensive user and installation instructions, download the user and installation guides via www.fisherpaykel.com

GET TO KNOW YOUR WASHER



Download the app for a smarter experience

- Access extra features and information
- Get the latest software updates
- Track and run cycles from your phone
- Customise your favourite cycles
- Register your products for streamlined support





FEATURES AND ACCESSORIES

- | | |
|--|----------------------------|
| 1 Touchscreen display | 5 Pump drain hose |
| 2 Power button | 6 Pump filter |
| 3 Detergent/Softener dispenser drawer | 7 Drum light (inside drum) |
| 4 Manual door-release tab (for use during power failure) | Dispenser cartridges (6) |

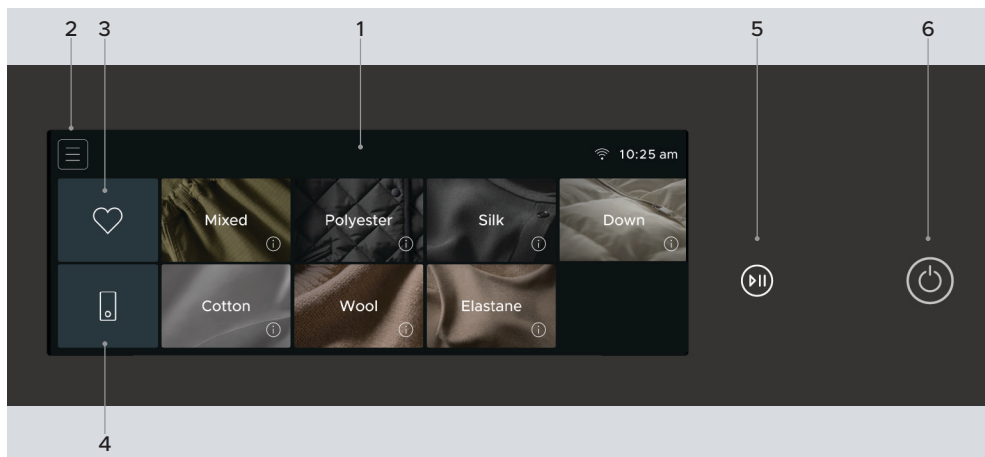
CONTROL PANEL



1	Touchscreen display	Use to navigate and select cycles, features and settings.
2	Menu	Press MENU  to access additional features and settings.
3	Favourites	Press FAVOURITES  to save cycles for quick access. You can save before, during or at the end of a cycle.
4	Remote	Press REMOTE  to connect appliance to your mobile device and operate it via the app.
5	Start/Pause	Press to start or pause a cycle or enable Remote mode.
6	Power	Press and hold to turn the appliance ON/OFF.

MENU

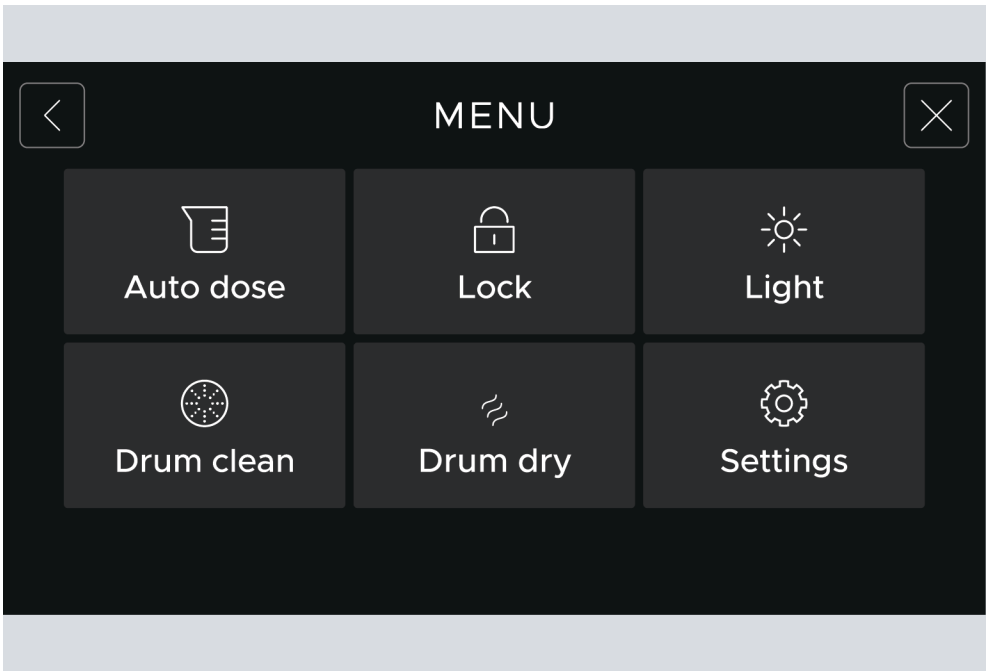

AUTO DOSE

Set or adjust detergent and softener dispensing tanks and dosage. See 'Set up Auto Dose'.



LOCK

Lock the controls at any time to prevent accidental use.



LIGHT

Set the drum light to turn on Automatically when you touch the display or set it to stay off.



DRUM CLEAN

Run a DRUM CLEAN cycle to clean the washer.



DRUM DRY

Run DRUM DRY or set it to run by default after a wash cycle.



SETTINGS

Set and adjust clock, display, volume and other settings to suit your preferences. See 'Adjust settings'.



BACK

Go back one level.



EXIT

Return to the home screen.



FIRST USE

Before you wash your first load, we recommend running a QUICK 15 cycle. This will prime the detergent dispenser and enable you to check that the hoses are connected properly and the washer is sitting level.

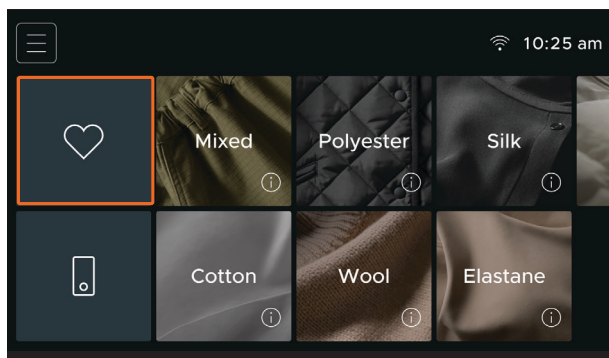

1. Add detergent to Tank 1.
Skip this step if you are not using the Liquid Detergent Auto Dose tank. The manual dispenser does not need to be primed.



2. Press FAVOURITE  and select QUICK 15.
FAVOURITE  is preset with QUICK 15 and QUICK 30 cycles. See 'Save Favourite cycle' for information about adding new favourite cycles.

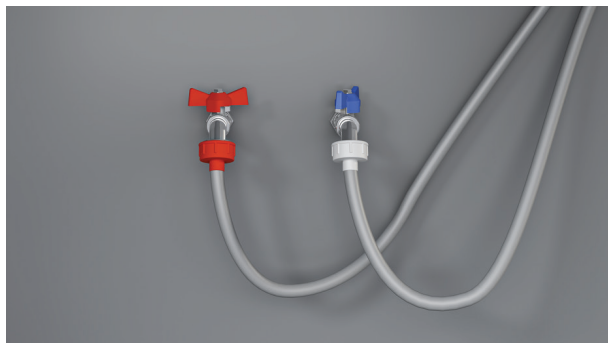

What to look for

- If the washer is leaking, check the hose connections.
- If the washer is moving around, adjust the feet to level it.

See the 'Installation guide' for instructions.

ADD DETERGENT OR SOFTENER

Your washer has three dispenser tanks for automatic and manual dispensing, giving you the flexibility to use a combination of detergents and softener.



Auto Dose tanks

Auto Dose tanks automatically dispense liquid detergent or fabric softener during a cycle. The dosage will adjust depending on the fibre, item type and treatment selected, as well as the load size and soil level.

- Tank 1** For everyday liquid detergent.
- Tank 2** Flexible tank. Can be used for softener (default), set to hold extra detergent as an extension of tank 1 or set for specialised detergent.

Each Auto Dose tank lasts for multiple cycles. Fill the Auto Dose tanks to the MAX line. When the tanks need to be refilled, a reminder will show on the screen.

See 'Set up Auto Dose' for how to set Auto Dose and adjust the dosage amount.

Manual dose tank

The Manual dose tank dispenses liquid or powder detergent. The dosage is determined by the amount of detergent you add to the tank, so only add as much detergent to the Manual tank as you need for that load.

To select Manual dispensing, select DISPENSING in the cycle settings, then select MANUAL. See 'Set a cycle' for details.

Select Manual for detergent pods

If using a detergent pod, set the dispenser to MANUAL and add the pod directly to the washer drum and put your items on top of it.

SORT YOUR ITEMS

Sorting your items well is essential for taking care of your clothes and getting the best results from your appliance. Follow these steps every time you use the washer.



1. Check each care label to see the fibre composition and how each garment should be washed. See 'Understanding fibre types.'



2. Sort items into loads of similar fibre, item type and item colour.



3. Check pockets, close fasteners and zippers, and untangle items before loading.

Use a small washbag for delicate items, and be careful not to overfill it.

UNDERSTANDING FIBRE TYPES

Every cycle starts with fibre type

Each fibre type responds differently to washing and drying. This appliance uses a fibre-led system and precision sensing to wash your items, so selecting the right fibre type for each load is key to setting the best cycle each time.

Treat for the most delicate fibre

Items may be a blend of multiple fibres — some more delicate than others. The care label on an item will tell you what fibre or fibres the item is made of and how to care for it.

Select the fibre type on your washer that applies to the most sensitive or delicate fibre in the blend, even if it is only a small percentage.

Identify delicate fibres

This table helps identify the most delicate or sensitive fibres commonly found on care labels. It also offers alternative cycle suggestions for most specialist fibres. Recommendations may not suit all items — always check your care label first.

For best results, use a detergent designed for the most delicate fibre. See 'Choose a detergent' for more information.

SENSITIVITY	COMMON FIBRES	FIBRE TYPE	ITEM TYPE
	Cashmere, Angora, Mohair	Not suited for machine washing in this model	
	Down	Down	
	Silk	Silk	
	Wool, Merino, Lambswool	Wool	
	Elastane, Spandex, Lycra	Elastane	
	Viscose, Bamboo, Rayon, Modal	Cotton	Ultra delicate
	Lyocell, Tencel™		
	Acrylic	Polyester	
	Linen	Cotton	
	Ramie		
	Nylon, Polyamide	Polyester	
	Polyester	Polyester, Mixed	
	Low	Cotton	Cotton, Mixed

LOAD THE WASHER

Maximum load size

The maximum load size changes based on the type of items in a load. Follow the guide below to avoid overfilling the washer and maintain good wash performance.



ITEM TYPES		MAX LOAD SIZE
Mixed, Cotton, Polyester	Ultra-delicate	Extra small
	Delicate, Denim, Sports	Small
	Moderate, Durable	Large
	Sheets, Towels, Bulky	Large
Wool	Ultra-delicate, Delicate	Small
Elastane	Ultra-delicate	Extra small
	Delicate	Small
	Moderate	Medium
Down	Ultra-delicate	Extra small
	Delicate	Small
Silk	Ultra-delicate	Extra small
Other Treatments	Favourite - Quick 15	Small
	Quick 30	Medium
	Refresh	1 or 2 Items
	UV Sanitise	As per fibre/item type
	Hot Sanitise	As per fibre/item type

SET A CYCLE

Your washer has specialised cycles for specific fibre types. Start by selecting a fibre type, then select an item type based on durability or specific items, such as sheets or towels, and the required treatment. You can adjust settings for soil level, colour and dispensing. The available cycle options may vary depending on the fibre type you select.

Automatic cycle settings

Cycle settings like temperature and spin speed no longer need to be set manually. These settings will all adjust automatically based on your cycle selections. Press **INFORMATION** ⓘ or see 'Cycle selections' for details about which fibre to choose.

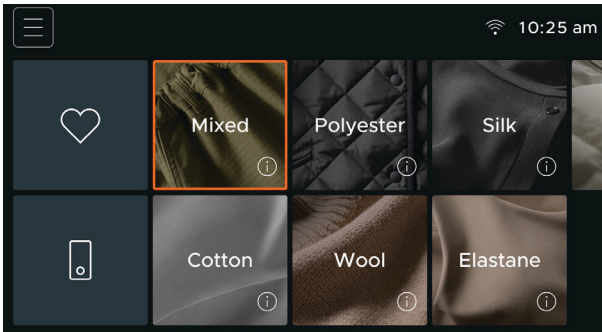

1. Press and hold **POWER**  to turn the washer on, then select a fibre type.

Press **INFORMATION** ⓘ for a description of each fibre.

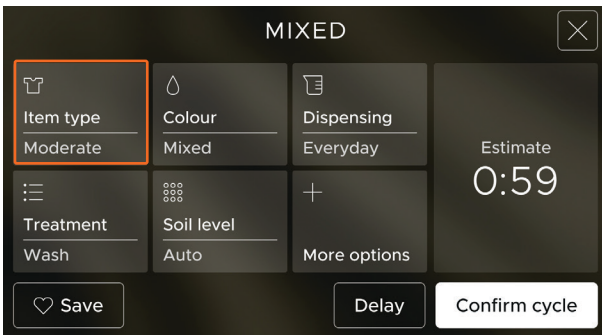

2. Press **ITEM TYPE** to access the options and see a description and examples for each type.

Scroll to select an item type.

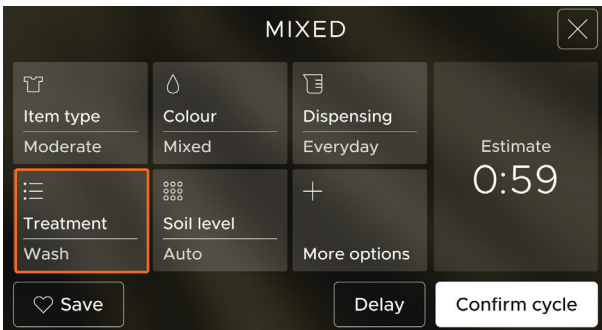

3. Press **TREATMENT** to access the options and descriptions.

Scroll to select a treatment.

SET A CYCLE

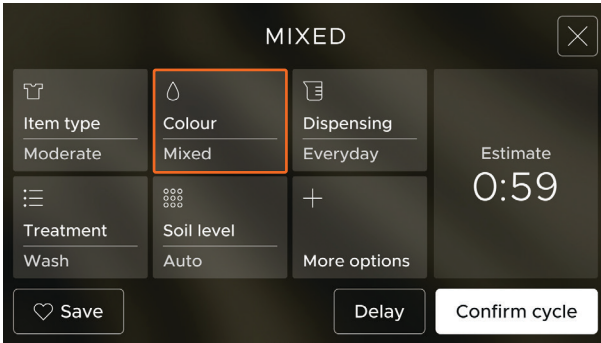

4. Press COLOUR to access the options.
Scroll to select a colour option.

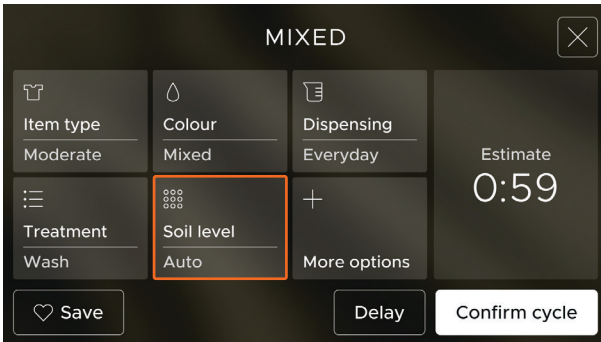

5. Press SOIL LEVEL to access the options.
Scroll to select a soil level.

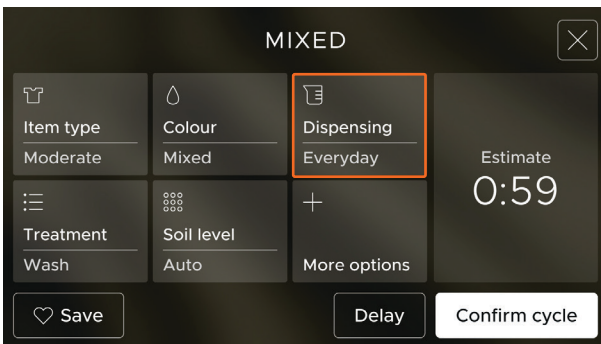

6. Select a dispensing option for detergent and softener.
You can select the Auto Dose tanks or the Manual tank.
See 'Add detergent and softener' and 'Set up Auto Dose' for details.

SET A CYCLE

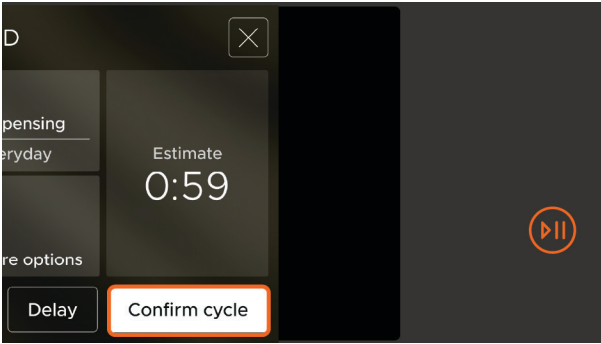

7. Press CONFIRM CYCLE, then press the START/PAUSE ▶|| button to begin the cycle. The cycle progress will show on the display.

See 'More options' for details about more wash options.

See 'Set Delayed start' for how to schedule your wash to start at a later time.

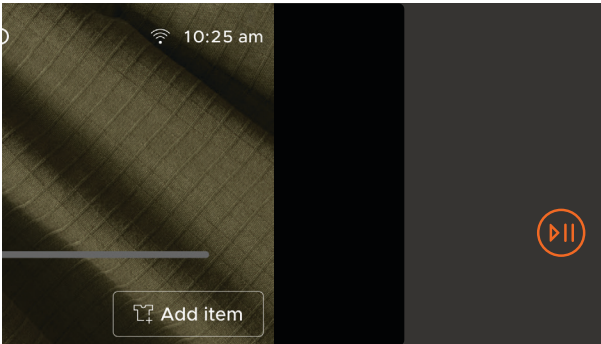

Pausing the cycle

Press the START/PAUSE ▶|| button to pause the cycle.

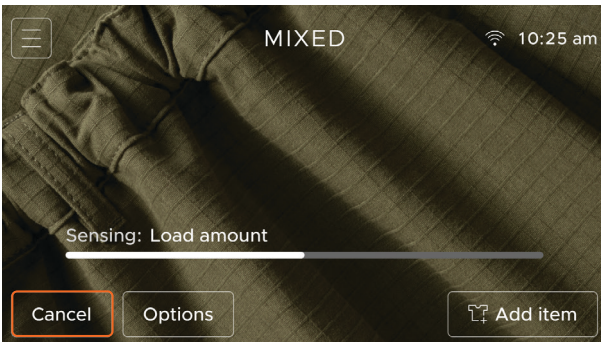

Cancelling the cycle

Press CANCEL and follow the prompts to cancel the cycle.

The door will remain locked until the water level has drained below the door.

SET UP AUTO DOSE

Use Auto Dose to set your preferences for everyday and specialised liquid detergents or fabric softener, and adjust the dose to suit your needs.

Once filled, the Auto Dose tanks automatically dispense the right amount for each wash. When the tanks need to be refilled, a reminder will show on the screen.

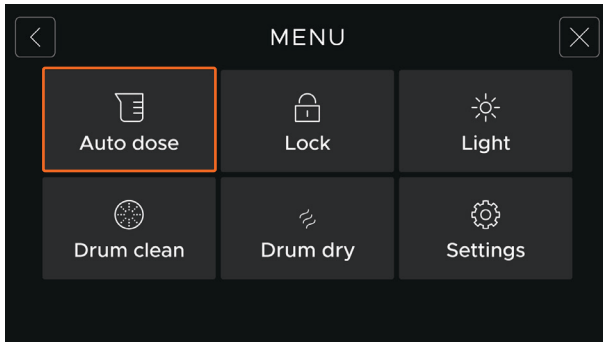

1. Go to MENU  and select AUTO DOSE or access it from DISPENSING during cycle setup.

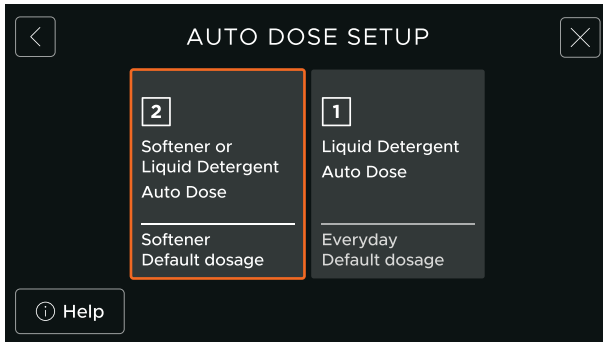

2. Select a tank.

Tank 1 is fixed to Everyday detergent, but you can adjust the dosage level.

Tank 2 can be set to Everyday or specialised detergent, or softener. When both tanks are set to Everyday, they automatically link to give more capacity and less frequent refills.

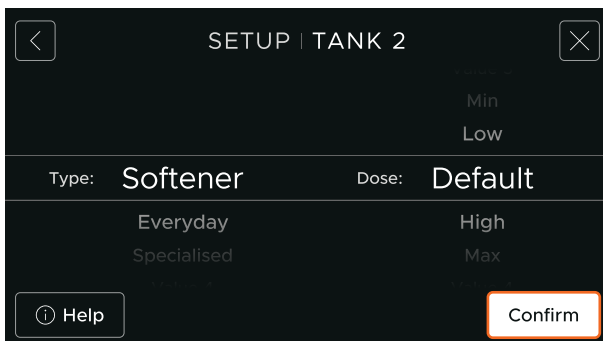

3. Scroll to assign a detergent or softener and dosage amount, then press CONFIRM.

MORE OPTIONS

Optimise	Optimise the cycle as required to save energy, reduce wash time or reduce noise. Select from Balanced, Energy, Time and Sound. Some optimise options are not available on certain cycles to ensure optimal wash results.
Pre wash	Add a pre wash to remove excess soil and ensure optimal wash results.
Cold wash	Use cold wash to minimise energy usage. If you live in a colder climate, you can change the temperature to a controlled 20°C so wash performance is not affected. See 'Adjust settings.'
Soak	Add extra time for items to soak halfway through the wash cycle. Ideal for helping to lift stubborn stains.
Extra rinse	Extra rinse cycle. Ideal for people with sensitive skin, or for heavily soiled items.
Sanitise method	Select your preferred method when treatment is set to Sanitise. <ul style="list-style-type: none">• UV uses ultraviolet light to eliminate bacteria without high temperatures. Not recommended for light-sensitive fibres like silk, wool and cashmere.• HOT WATER is an extra hot treatment for items that can handle high temperatures, like tea towels, dishcloths, towels and sheets.
Crease free	After the cycle is complete the load will continue to tumble periodically to help reduce creases. Crease free will remain active for up to 12 hours or until cancelled. To cancel, touch the screen or open the door.
Drum dry	Runs the fan and periodically rotates the drum to reduce dampness once a cycle is complete and laundry is removed. To activate, remove laundry, close the door and press START.



1. Press MORE OPTIONS to access extra wash options.



2. Select a wash option and follow the onscreen instructions to set it. Press DONE to confirm.

MORE OPTIONS

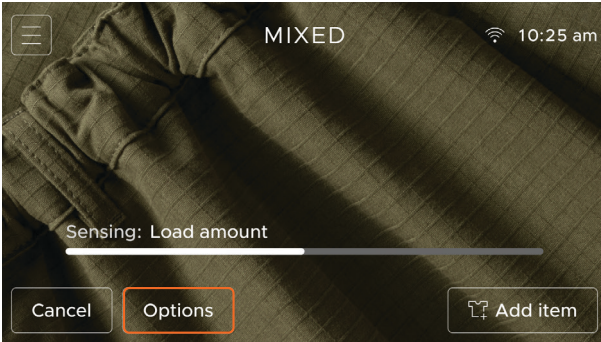

1. Press **OPTIONS** from the cycle screen to review your settings, save them as a favourite or to access remote mode.

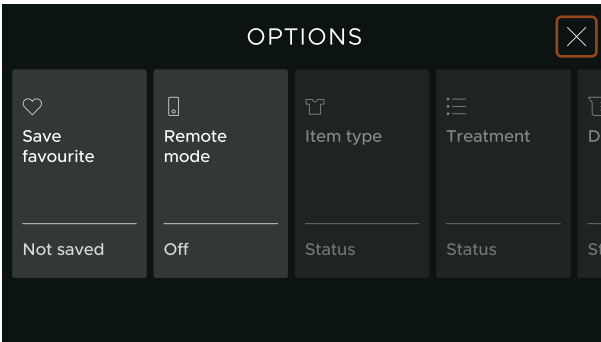

2. Select new option.

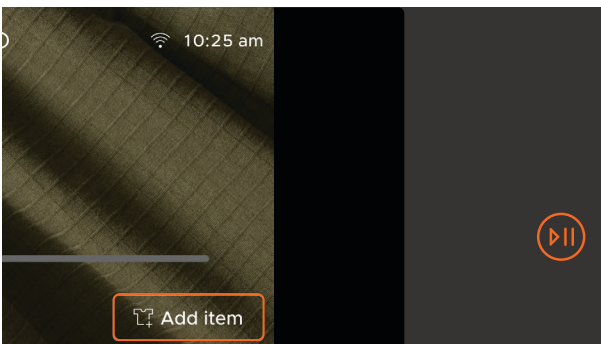

Add Item

Press **ADD ITEM** to pause the wash and add an item. For best results, add within 10 minutes of starting the cycle. The washer may drain slightly so door can open safely.

Not available on all cycles.

Press **RESUME**, then press the **START/PAUSE** button to resume the cycle.

SET DELAYED START

DELAY allows you to schedule a cycle to begin at a later time. You can set a time on the washer or start a cycle remotely through the app.

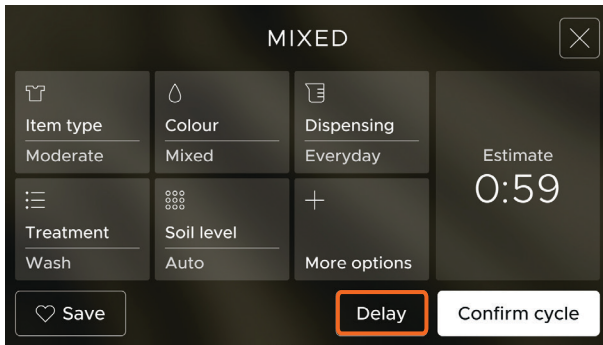

1. After setting the cycle, press DELAY to open the Delay screen.

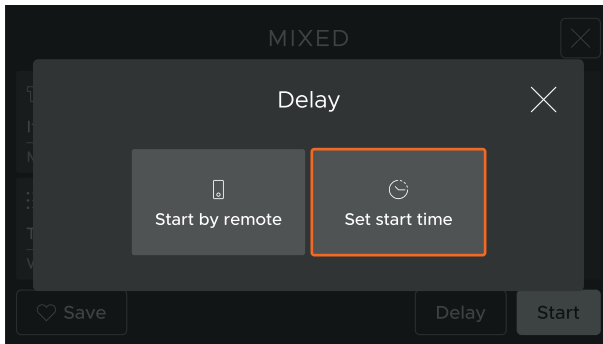

2. Press SET START TIME and follow the onscreen instructions to set a delayed start time.

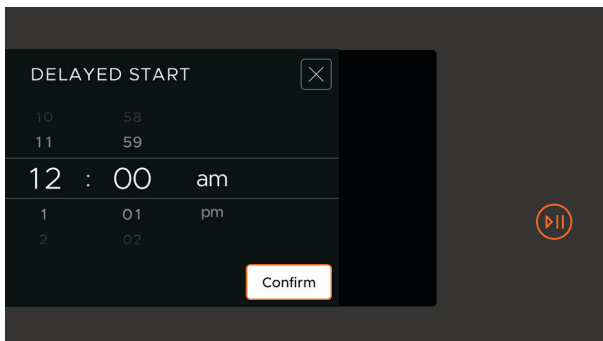

3. Press CONFIRM to save the new start time, then press the START/PAUSE button.

SAVE FAVOURITE CYCLES

Save your favourite cycles for a quick start to your wash. Favourites comes with preset QUICK 15 and QUICK 30 cycles, and you can save up to 14 more on the appliance and manage them in the app.

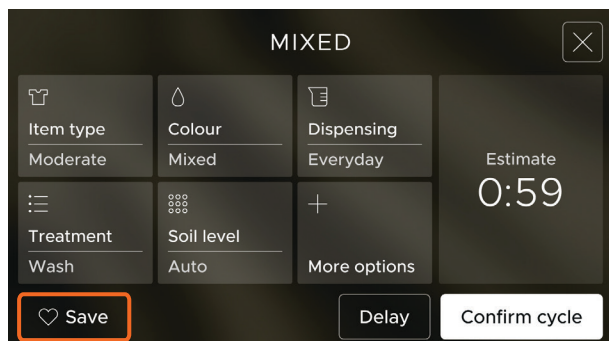

1. Press **SAVE**  from the cycle settings screen, from the Options menu or at the end of a cycle to add the cycle to Favourite.



2. Create a custom name for your cycle, or skip that step and save it with a default name.

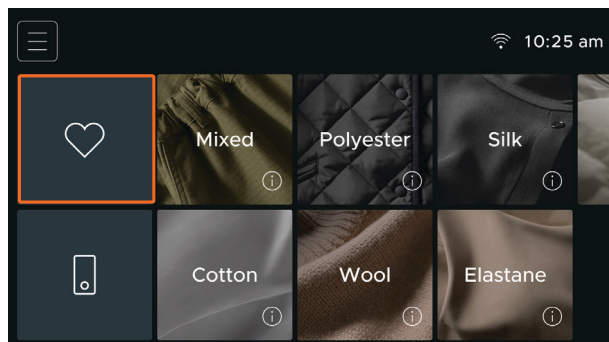



3. Press **FAVOURITE**  on the home screen to access your saved favourite cycles.

SAVE FAVOURITE CYCLES



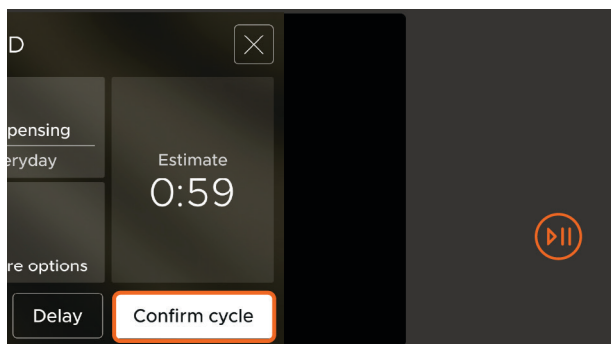

4. Select a favourite cycle from the Favourites menu.

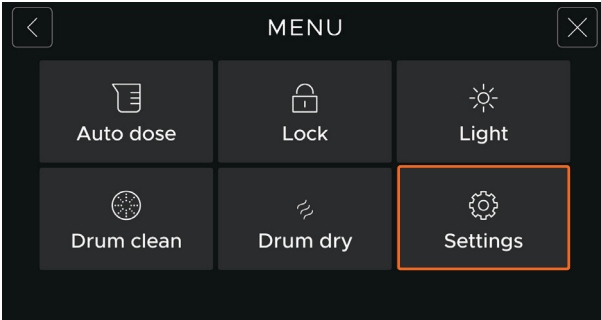

5. Press CONFIRM CYCLE, then press the START/PAUSE  button to start the wash cycle.

ADJUST SETTINGS



Go to MENU  and select SETTINGS.

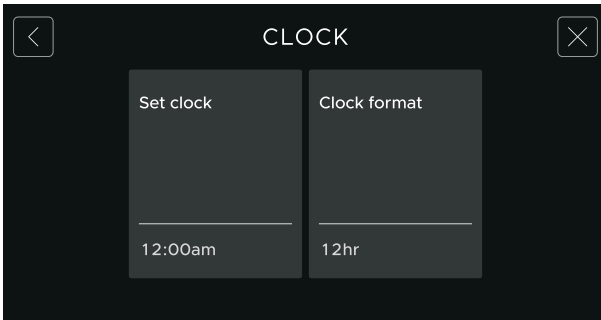

Clock
Set time, format and time zone.
Time updates automatically when connected to Wi-Fi.

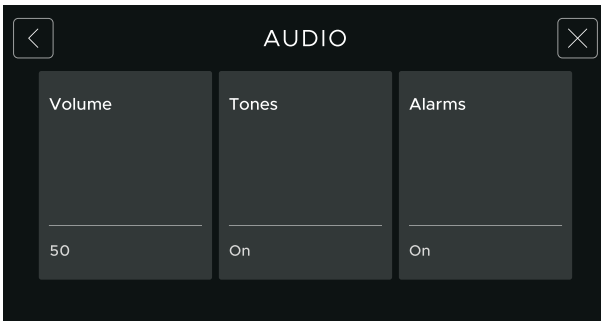

Audio
Set volume or turn sounds on or off.



Factory default reset
Restore all settings to factory defaults.
This action cannot be undone.

ADJUST SETTINGS

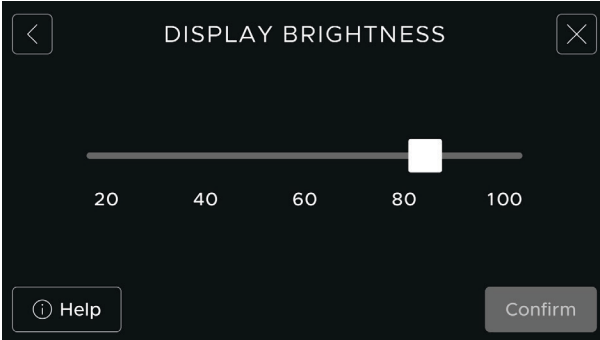

Display

Adjust the brightness of the display screen. Set a lower brightness to improve energy efficiency.

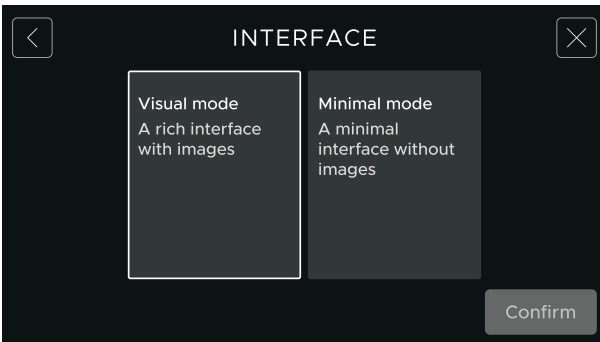

Interface

Set visual or minimal modes on the display.

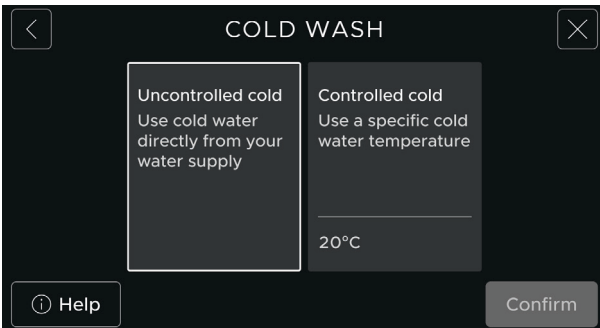

Cold wash

Set the temperature for Cold wash. Use Controlled 20°C for colder climates if you notice changes in performance.

WI-FI CONNECTION AND REMOTE MODE

Connect your appliance to your home wireless network to access extra features, receive updates and operate the appliance remotely using the app.

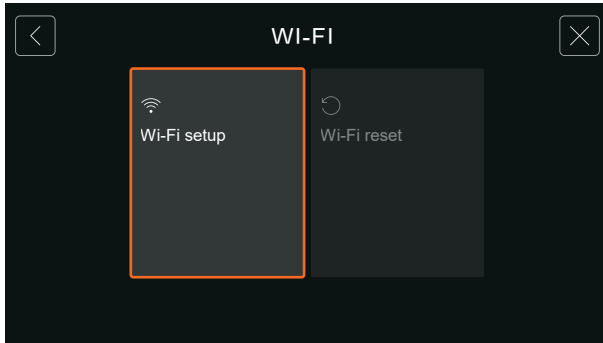

Connect to Wi-Fi

1. Go to the menu and select **SETTINGS**, **WI-FI**, then **WI-FI SETUP**.

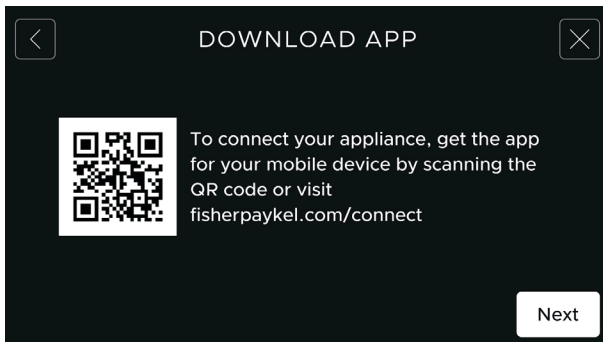

2. Download the app, and follow the app instructions.

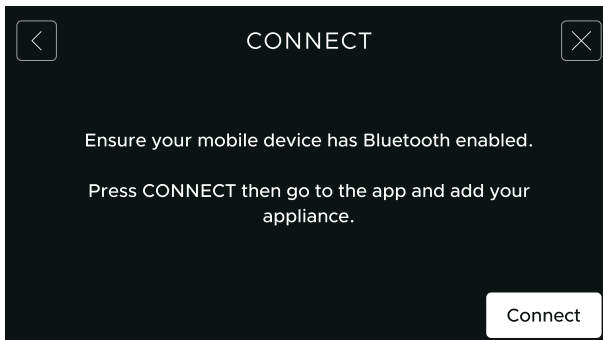

3. Enable Bluetooth on your mobile device, then press **CONNECT**.

Go to the app to complete the connection.

WI-FI CONNECTION AND REMOTE MODE

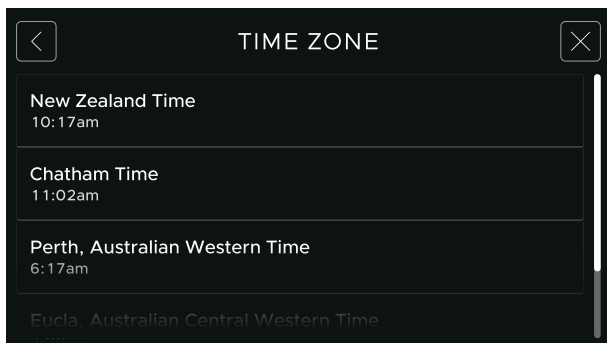

4. On your appliance, select the relevant time zone.



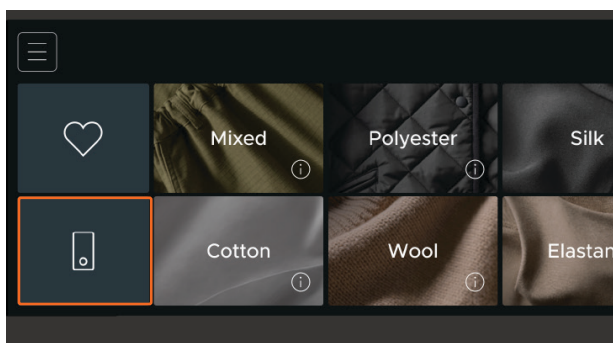

Disconnect Wi-Fi

Go to **SETTINGS** and select **WI-FI**, then **RESET** to disconnect.



Enable Remote mode from the home screen

Press **REMOTE** , then **ENABLE**. Press the **START/PAUSE**  button to enable Remote mode and manage cycles in the app.

WI-FI CONNECTION AND REMOTE MODE



Enable Remote mode during cycle setup

1. Press DELAY in the cycle setting screen.

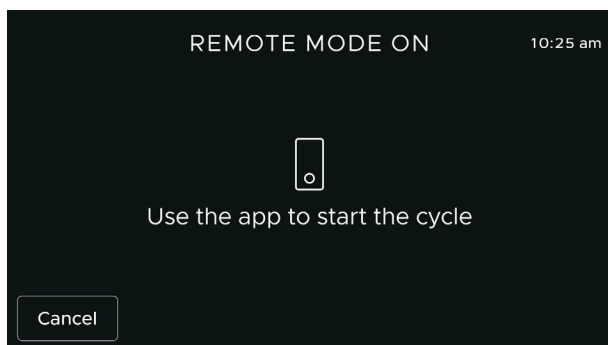

2. Press START BY REMOTE, then press the START/PAUSE button to enable Remote mode and manage cycles in the app.

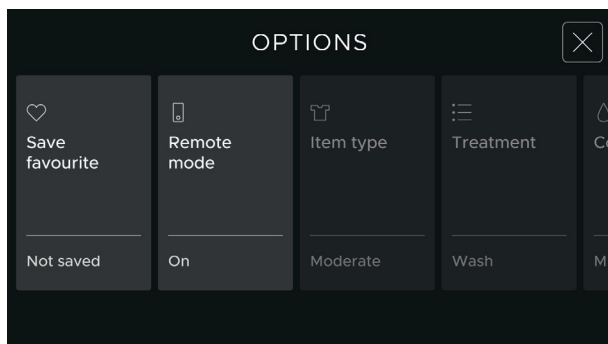

Turn Remote mode off

On the cycle screen, press OPTIONS, then REMOTE MODE to turn off, or open the washer door.

CYCLE SELECTIONS

FIBRE TYPE

Select the specific fibre type that matches the load or choose the fibre type that applies to the most delicate fibre. The wash cycle will adjust to suit.

Mixed

For everyday mixed loads with a variety of fibres, and for cotton-polyester blends.

Cotton

For 100% cotton items, cotton blends and compatible fibre types.

Polyester

For 100% polyester items and compatible fibre types.

Elastane

For items containing 10-50% elastane fibre, also known as spandex.

Down

For items containing down fill.

Silk

For 100% silk items and silk blends.

Wool Care

For 100% woollen items and wool blends. This cycle meets the Woolmark requirements for drying and washing items labelled “machine wash”.

Most woollen handcrafted garments are not made of machine washable wool and we recommend that you wash them by hand only. Hand-washed woollens may still be spun in your washer, but ensure they have been well wrung out before placing them in the washer.

Washing underlays and sheepskins is not recommended because they could produce excessive amounts of lint that may cause pump blockages.

ITEM TYPE

Item Type relates to the durability of items in your load. Wash garments and items of similar durability together.

Durable

Strong and resilient items like workwear and outerwear.

Moderate

Everyday items like t-shirts, shirts, shorts and pants.

CYCLE SELECTIONS

Delicate

Light and easily damaged items like blouses, dresses and other items.

Ultra-delicate

For items that are very fragile, needing extra gentle care. Ideal for lace, lingerie and fine knitwear.

Sports

Durable sportswear items made from synthetic fibre blends.

Denim

Denim or stretch denim items like jeans, jackets and skirts.

Sheets

Items such as bed sheets, pillow cases and duvet covers.

Towels

High absorbency towelling fabric items like bath, beach and hand towels.

Bulky

For items that are thick and insulating, such as blankets, quilts, comforters, and duvet or doona inners.

TREATMENT

Treatment lets you select from a range of specialised wash treatments to suit your needs.

Wash

A tailored wash, rinse and spin based on fibre and item type selection to remove soils. Detergent dose, water temperature, wash times, tumble patterns and spin speeds are optimised based on fibre type, item type and load size to ensure perfect results.

Refresh

Designed to refresh dry items using steam and tumbling to reduce creases and odours. For best results use this cycle for one or two items at a time. Ideal for items like dress shirts to refresh before ironing.

Hot Sanitise

An extra hot treatment designed to eliminate bacteria. Ideal for sanitising items that can handle high temperatures like tea towels, dishcloths, towels and sheets, but unsuitable for delicate items.

CYCLE SELECTIONS

UV Sanitise

A low temperature sanitisation treatment that uses ultraviolet light to eliminate bacteria. Ideal for sanitising everyday items without exposing them to high temperatures.

Rinse

A tailored rinse and spin based on fibre and item selection. Removes detergent and prepares items for drying.

Spin

A tailored spin based on fibre and item selection. Items are spun at an optimised speed to remove excess moisture. Ideal for preparing clothes for drying.

Allergy Care

Uses higher wash temperatures and additional rinse cycles to reduce detergent residue and allergens like dust mites and pollen. Ideal for helping to manage allergies or sensitive skin.

COLOUR

Different colours require different care. Colour selection adjusts the wash temperature automatically to suit the items in the load.

Dark

Designed to care for dark-coloured items with a cooler wash to help preserve vibrancy and prevent fading.

Mixed

Designed to care for loads with a mixture of colours. Ideal for everyday laundry loads, providing a balanced wash temperature to preserve vibrancy and help prevent colour transfer.

Light

Designed to care for light-coloured items with an optimised wash temperature to help maintain brightness.

White

Designed to care for white items with an optimised wash temperature to help maintain whiteness.

SOIL LEVEL

Soil Level adjusts the wash cycle based on the soil level of items. Leave on Auto or select a soil level to suit the load. The wash time and detergent dose will automatically adjust to suit your selection.

CYCLE SELECTIONS

Auto (default)

Senses the dirt levels in a load. The wash time and detergent dose will adjust automatically for optimal cleaning efficiency.

Heavy

For items with high levels of soiling, using higher detergent dosage and longer wash times.

Moderate

Ideal for everyday laundry loads, providing a balanced wash cycle with optimal detergent dosage and wash time.

Light

For items with low levels of soiling, reducing detergent dosage and wash time.

WASH TEMPERATURES AND SPIN TREATMENTS

Wash temperatures and spin speeds are set automatically based on your fibre, item type and colour selections. This ensures the best wash results for your items.

See below for a general guide to how colour selection affects wash temperature and how item type affects spin speed. Not applicable to all fibre types.

WASH TEMPERATURE

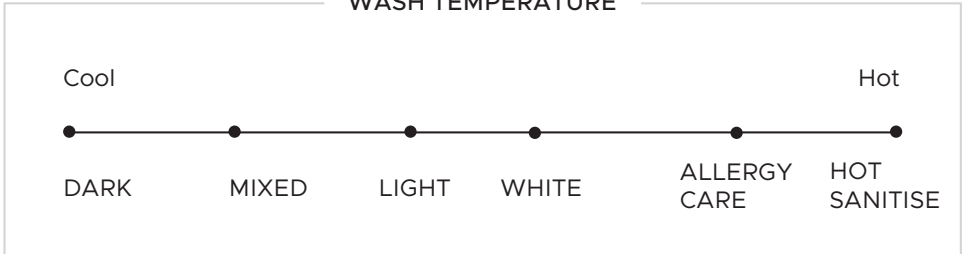

SPIN SPEED

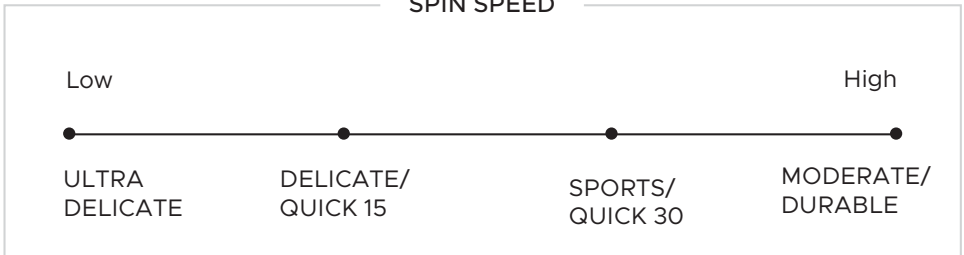

CHOOSE A DETERGENT

Specialised detergents provide the best wash performance for different items. We recommend using a specialised detergent type where relevant.

If switching detergent types between loads, we recommend cleaning the dispenser drawer to remove unsuitable detergent before washing items with a specialised detergent. See 'Clean the dispenser drawer'.

Everyday

For your everyday items that do not require specialised care.

Darks

Dark detergents are specially designed to keep darks vibrant and prevent dye transfer during the wash. Avoid using darks detergents with white or light-coloured items.

Whites

Whites detergents are designed to brighten your white items as they typically contain whitening agents. Avoid using whites detergents with coloured or dark items.

Sensitive

For items of users with sensitive skin. Sensitive detergents are typically free from fragrance and colourants, safer for those with allergies or asthma, and ideal for baby clothes.

Delicates

For delicate and ultra-delicate fabrics. Delicate detergents preserve fibres while maintaining softness.

Wool

Wool detergents are ideal for all types of woollen items to gently clean and maintain softness.

Silk

Silk detergents are ideal for washing item types containing silk fibres, preserving fibres while maintaining softness and lustre.

Down

Down detergents are designed for gently cleaning filled down garments, restoring loft, removing odours and revitalising water repellency. Typically these detergents are also designed for synthetic filled garments.

Softener

Softeners are for conditioning items, giving them a softer feel. Softeners are dispensed during the rinse phase to prevent mixing with detergents.

CLEAN AND MAINTAIN YOUR APPLIANCE

Surfaces and accessories

Wipe with a damp cloth and dishwashing liquid, then dry with a clean, lint-free cloth. We do not recommend using the following cleaning products as they may cause damage:

- Plastic or stainless steel scouring pads
- Abrasive, solvent, household cleaners
- Acid or alkaline cleaners
- Handwash or soap
- Stainless steel cleaners or polishes
- Laundry detergents or disinfectants

Cleaning the drum and the door

- Run the Drum Clean cycle.
- Wipe the rubber seal around the door to prevent odours. Remove any items or lint and wipe out any water.
- Remove dirt or lint from the drum and wipe it clean. Do not leave metal objects in the drum as these may rust and cause staining.
- Leave the door open when not in use to prevent odours. Keep children and pets away from the washer so they cannot become trapped inside it.

Cleaning the hose(s)

Each hose contains a filter to stop contaminants in the water from entering your washer. Occasionally, disconnect the hoses where they connect to the taps and wash out any dirt build-up.

Moving your washer

- Remove the dispenser drawer and empty out any detergent or softener. Refer to 'Clean the dispenser drawer.'
- Clean the pump filter and ensure any water in the washer is drained. Refer to 'Clean the pump filter'.

Products that might damage your washer

- Concentrated bleaches, laundry pre-soakers/sanitiser, stain removers and hydrocarbon solvents (eg petrol and paint thinners) can cause damage to the surfaces eg control panel, and components of your washer.
- Be careful when washing items stained with solvents as they are flammable. DO NOT put them in your dryer.
- Use of dyes in your washer may cause staining of the plastic components. The dye will not damage the washer but we suggest you thoroughly clean your washer afterwards. We do not recommend the use of dye strippers in your washer.
- Nappy sanitiser and bleach are very corrosive to metal surfaces. DO NOT tip the contents of a nappy bucket into your washer. Rinse and wring items out thoroughly before placing them in the washer.

CLEAN THE DISPENSER DRAWER

Check and clean the dispenser drawer regularly to remove build-up and when switching between detergents or softener in Tank 2.



1. Push the dispenser drawer to open it, and push down on the tab to the left of the MANUAL DOSE compartment. Remove the drawer from the washer.

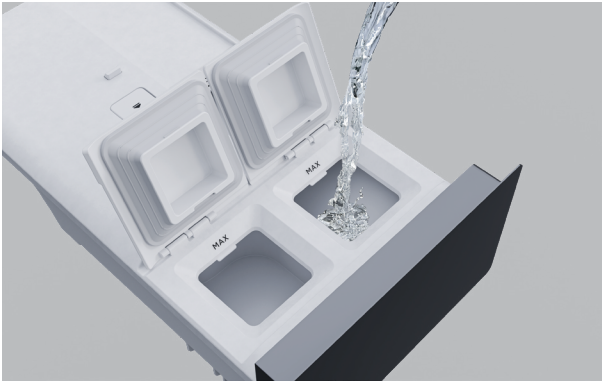

2. Drain residual detergent, then fill the compartments with warm water, and shake lightly to clear residue.

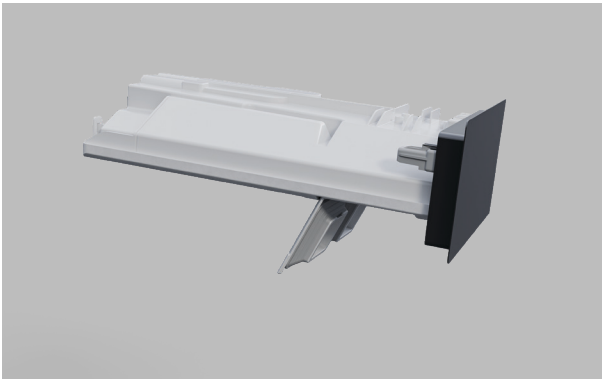

3. Drain all water from the compartments and allow to dry before refitting the dispenser drawer to the washer.

RUN THE DRUM CLEAN CYCLE

DRUM CLEAN is a hot water cycle designed to be used with Washing Machine Cleaner to remove any buildup and odours. A reminder will display after 50 cycles.

Run the drum clean cycle when you see the reminder or more frequently if you use Eco or liquid detergents and low-temperature cycles.



1. Ensure the drum is empty, then add Washing Machine Cleaner directly into the drum.

Follow the manufacturer's instructions for recommended dosage.

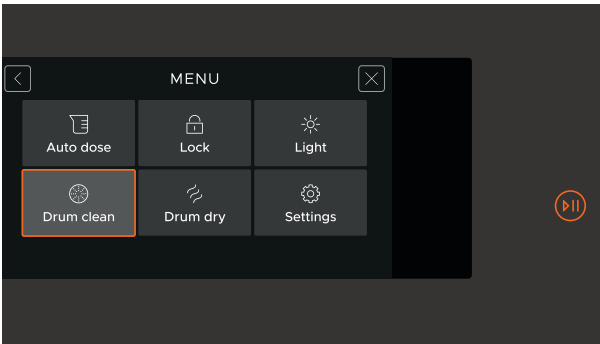

2. Go to MENU  and select DRUM CLEAN.

Press CONFIRM CYCLE, then press the START/PAUSE  button to begin the cycle.

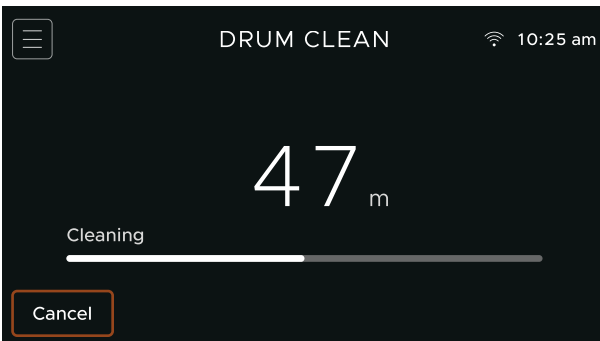

3. The cycle progress will show on the display. Press CANCEL to cancel the cycle.

UNLOCK THE DOOR

In a power failure, you can use the door-release tab to unlock the washer door and remove items, but you must drain the washer first.

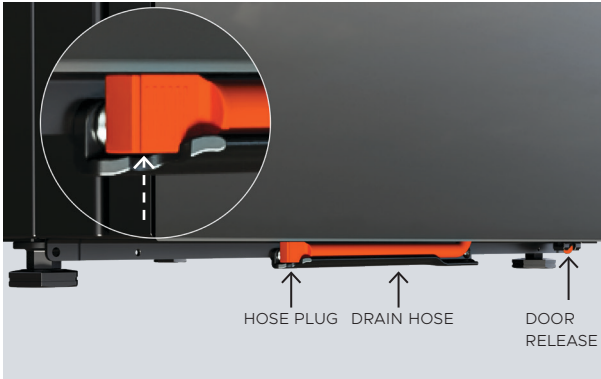

1. Use your fingers to lift the drain hose at the plug end and unhook it from under the washer.

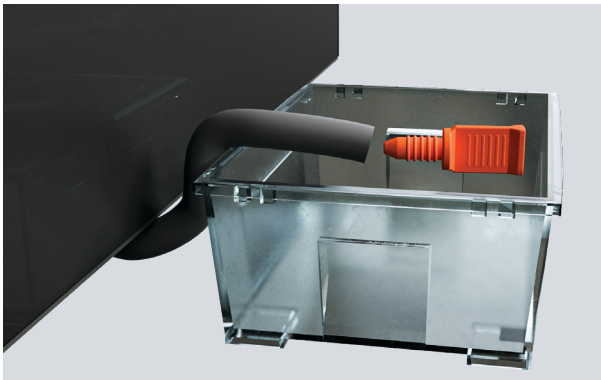

2. Position the hose over a shallow container, and remove the hose plug. Drain water from the washer so it is safe to open the door.

Replace the plug after draining, and refit the hose in its housing.



3. Use a suitable tool to pull down the door-release tab and unlock the door.

Place your hand on top of the tool, hold it parallel to the floor, and push downward to lower the tab.

Do not use the door as a lever point.

CLEAN THE PUMP FILTER

Check and clean the pump filter when you see an onscreen alert or you notice the washer is not draining. Turn the washer off at the wall before you remove any parts.



1. Unlock and open the door, then push on the filter cover to access the filter.

See 'Unlock the door' for door-opening instructions.

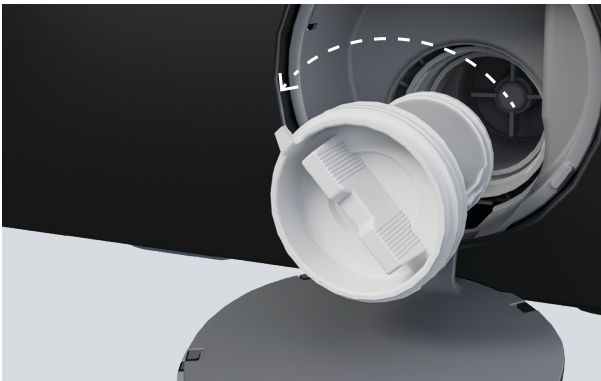

2. Turn the filter anti-clockwise to remove it, then clean and rinse it.

Some water may leak out when you remove the filter.



3. Check and clear the cavity behind the filter, and check that the impeller in the cavity moves freely.

CLEAN THE PUMP FILTER





4. Refit the filter, and turn it clockwise until the handle is in the vertical position.

TROUBLESHOOTING

Why will the appliance not turn on?

- No power. Check the appliance is connected to the power supply. Press and hold POWER  to turn the appliance on.
-

Why is the display not responding?

- Appliance needs time to start up when first powered on. This can take 30 seconds.
 - Appliance needs to be reset. Press and hold POWER  to turn the appliance off. Wait a few seconds, then turn it back on. If the problem persists, disconnect from the power supply, wait a few seconds, then reconnect and press and hold POWER .
 - Controls are locked. Press and hold the screen to unlock.
-

Why can't I see all the cycle settings and features on my washer?

- Software needs to be updated. Connect your washer to the app to get the latest updates and access extra features. See 'Wi-Fi connection and remote mode'.
-



Why is the washer not starting?

- Door not closed. Check nothing is obstructing the door, and close it firmly.
 - Cycle confirmed but not started. Press the START/PAUSE  to start the cycle.
 - Washer is overloaded. Remove some items and restart the cycle.
 - Delay start is set. See 'Set Delay start'.
 - The controls are locked. Press and hold the screen to unlock.
 - Hot and cold taps not turned on. Turn on the hot and cold water and resume cycle.
 - There is a fault. See 'Fault codes'.
-



Why is the washer stopping and starting?

The CREASE FREE setting is turned on. Press CREASE FREE  to turn off.

Why did the washer stop mid-cycle?

- Cycle has been paused. Press RESUME then START/PAUSE  to resume the cycle.
 - The door is open. Close the door and press START/PAUSE  to resume the cycle.
 - Washer may have detected suds and is waiting for them to dissolve before continuing the cycle.
-

Why is the washer vibrating or making noises?

- Transit bolts may still be in place. Refer to installation guide for how to remove them.
 - Washer overloaded. Press START/PAUSE  to pause the cycle and remove some items.
 - Washer not level. Refer to installation guide for instructions about levelling the washer.
 - Load out of balance. Press START/PAUSE  to pause the cycle and redistribute items.
 - Washer has a fault. See 'Faults'.
-

TROUBLESHOOTING

Why is the wash cycle taking so long?

- Washer is overloaded. Pause the cycle and remove some items.
 - Items are tangled. Untangle the items and resume the cycle.
 - Incorrect settings for the load. Check the selected fibre type, item type and treatment and adjust if required.
 - Washer is not draining. Check the drain hose for blockages and correct if possible. If the problem persists contact Customer Care.
-

Why is the fabric damaged after a wash cycle?

- Cycle settings not appropriate for the load type. Follow instructions on care labels and sort items accordingly. See 'Sort your items'.
 - Metal parts on the items or in the load may catch on fabric. Always fasten zips, velcro and other clasps before placing items in the washer.
-

Why do items keep getting tangled?

- Loads not separated before going in the washer. Load items individually and try separating larger items from smaller items.
 - Load size is too large. Try washing smaller loads. See 'Load the washer'.
 - Wash big items like sheets and duvet covers separately and use the Sheets item type.
 - Cycle settings not the best option for the load type.
 - Delicate items not separated. Wash pantyhose, bras and stockings in a small washbag.
-

Why do items keep getting creased?

- Items have been left in the washer after the cycle ended. Turn CREASE FREE $\}}|$ on at the start of the cycle to minimise creasing.
 - Washer is overloaded. Press ADD ITEM \uparrow to pause the wash and remove items. See 'Wash options'.
 - Select the Delicate or Ultra Delicate Item type. This will reduce spin speed and minimise creases.
-

Why is dye transferring between my items?

- Items not sorted before going in the washer. Separate white and coloured items into separate loads.
 - Cycle settings not appropriate for load type. Select the relevant COLOUR option for your load.
-

Why is the washer not draining?

- Pump filter needs to be cleaned. See 'Clean the pump filter.'
 - Drain hose not connected correctly. See the installation guide for instructions.
 - Drain hose or drain is blocked. Check the drain hose and drain for blockages and correct if possible. If the problem persists contact Customer Care.
-

TROUBLESHOOTING

Why is the washer beeping?

- The cycle has ended. Items can be removed.
 - Washer has a fault. See 'Faults'.
-

Why is water coming from under the washer?

- Door not closed. Check nothing is obstructing the door, and close it firmly.
 - Dispenser drawer not closed. Close it firmly.
 - Drain hose or drain is blocked. Check the drain hose and drain for blockages and correct if possible. If the problem persists contact Customer Care.
 - Drain hose not connected correctly. See the installation guide for instructions.
-

Why is my washing wetter than I expect at the end of the cycle?

- Out of Balance load affecting spin speed. Redistribute the load and run a spin treatment to remove excess water.
 - Quick or delicate cycles have lower spin speed and can result in wetter washing at the end of the cycle. Select Moderate and Durable treatments as these have faster and longer spin times.
-

Why are my clothes not as clean as I expected?

- Incorrect settings for the load. Select a higher SOIL LEVEL or more durable item type.
 - Not enough detergent. Increase detergent amount by increasing SOIL LEVEL or adjusting AUTO DOSE amount.
 - Washer overloaded so can't wash items properly. See 'Load the washer' for maximum load capacity guidance.
 - Ineffective detergent. Use a good quality detergent for best results.
 - Washer still has residue from previous wash. After washing particularly soiled clothing, empty the washer and run a RINSE cycle to remove residual dirt.
-

Why is the remaining cycle time not accurate?

Cycle time is an estimate based on load size and water flow rates. It adjusts throughout the cycle to give you an estimation of minutes remaining. The time shown is not the Declared Program Time.

Why does my item have wet patches on after a REFRESH cycle?

This is normal and helps remove wrinkles. Remove the item from the washer immediately at the end of the cycle and hang up to dry for a few minutes before wearing.

Why does my washer smell after a cycle?

- Drum and door need to be cleaned. See 'Clean and maintain your appliance'.
 - Try using a different detergent.
 - Leave the washer door open slightly after a cycle so it can dry out.
-

FAULTS

How do I know if there is a problem?

Your appliance will beep and an alert will show in the display.

What to do

First try to fix the issue and clear the alert according to the onscreen instructions.

If the problem persists

- 1 Note down the fault code.
- 2 Contact Customer Care or a Fisher & Paykel trained and supported service technician. Refer to the Service and Warranty booklet for contact details.

COMPLIANCE INFORMATION

Energy and Water Label Cycle

The cycle for energy and water labelling in accordance with AS/NZS 2040: 2021 and AS/NZS 6400: 2016 is as follows: Cotton, Item: Durable, Colour: White, Dispensing: Manual Dose, More Options - Optimise: Energy. This cycle is the recommended energy and water saving cycle for normally soiled everyday washing, equal to the rated capacity.

Note for Testing Laboratories: The powder detergent is placed directly into the bottom of the drum. No more than the maximum amount of anti-foaming agent is then placed into the bottom of the drum followed by the PBIS solution. The load is then added in accordance with AS/NZS 2040: 2021.

UV Sanitise (20°C)

This cycle complies with the bacterial removal requirements of GB 21551.5-2010 Average elimination rate for the following bacteria, Staphylococcus aureus & Escherichia coli >99.9%.

Fibre: COTTON, Item Type: DURABLE, Treatment: SANITISE, Colour: DARK 20C, Soil Level: MODERATE, AutoDose: MANUAL.

Hot Sanitise

This cycle complies with the bacterial removal requirements of GB 21551.5-2010. Average elimination rate for the following bacteria, Staphylococcus aureus & Escherichia coli >99.9%

Fibre: MIXED, Item Type: MODERATE, Treatment: SANITISE, Colour: MIXED, Soil Level: MODERATE, AutoDose: MANUAL, More Options: SANITISE METHOD - HOT WATER.

Allergy Care

This cycle complies with the dust removal requirements of QB/T 5958-2023. Average elimination rate for the following allergen Dermatophagoides farinae =100%

Fibre: COTTON, Item Type: MODERATE, Treatment: ALLERGY CARE, Colour: MIXED, Soil Level: MODERATE, AutoDose: MANUAL

Woolmark

The wool wash cycle of this machine with a capacity of 4kgs has been approved by The Woolmark Company for the washing of machine washable wool products provided that the products are washed according to the instructions on the garment label and those issued by the manufacturer of this washing machine M2528. (WH1260MZB5)

Fibre: WOOL, Item Type: DELICATE, Treatment: WASH, Colour: WHITE, Soil Level: LIGHT AutoDose: MANUAL.



MANUFACTURER'S WARRANTY AND SERVICE GUIDE

NZ



To access your Warranty and Service Guide

Scan the QR code with your smartphone to access your warranty and book a service, or view online at <https://www.fisherpaykel.com/nz/help-and-support/warranty-information>

AU



To access your Warranty and Service Guide

Scan the QR code with your smartphone to access your warranty and book a service, refer to your separate warranty and service book or view online at <https://www.fisherpaykel.com/au/help-and-support/warranty-information>

This product has been designed for use in a domestic (residential) environment. This product is not designed for any commercial use. Any commercial use by the customer will affect this product's Manufacturer's Warranty.

Complete and keep for safe reference:

Model _____

Serial No. _____

Purchase Date _____

Purchaser _____

Dealer _____

Suburb _____

Town _____

Country _____

FISHERPAYKEL.COM

© Fisher & Paykel Appliances 2026. All rights reserved.

The models shown in this guide may not be available in all markets
and are subject to change at any time.

The product specifications in this guide apply to the specific products and
models described at the date of issue. Under our policy of continuous product
improvement, these specifications may change at any time.

For current details about model and specification availability in your country,
please go to our website or contact your local Fisher & Paykel dealer.

433544A 04.26