

# 36" Series 7 Integrated French Door Refrigerator Freezer, Ice & Water

Integrated



This large capacity refrigerator with bottom freezer seamlessly integrates into your kitchen, fitting flush into your cabinetry.

- ActiveSmart™ technology helps keep food fresher for longer by constantly maintaining the ideal temperature
- SmartTouch control panel ensures ease of use
- Spacious bottom freezer featuring a full-extension drawer and an ice maker with boost function
- Stainless steel door panels and handles are available for separate purchase

## DIMENSIONS

Height	79 13/16 "
Width	35 1/16 "
Depth	23 3/4 "

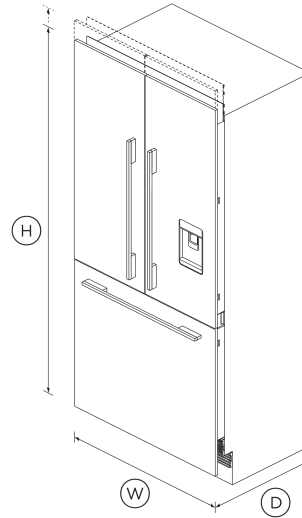

## FEATURES & BENEFITS

### Perfect Fit

These models fit flush and have minimal gaps, with no visible hinges. Purchase our stainless steel door panel and handles separately for a sleek, modern finish that complements your kitchen's style.

### ActiveSmart™ Foodcare

ActiveSmart™ Foodcare learns how you live. By understanding how you use your refrigerator and adjusting temperature, airflow and humidity inside, it helps keep food fresher for longer.

### Flexible Storage

Designed to make it simple for you to store, sort and access food. Storage bins give you full access inside when they're pulled open and can be easily removed to clean. Our cantilevered shelving also gives you more storage options.

### Water dispenser

The slimline dispenser makes it easy to fill almost any sized jug or vessel with cool filtered water without taking up any storage space in your fridge.

### Ice maker

Fresh ice is always available for you in a dedicated freezer bin. Simply turn it off to free up freezer space or during busy times, you can boost ice production by up to 30%.

### Beautiful Lighting

LED lighting illuminates the interior with a crisp, clean glow for enhanced visibility. Our energy saving LEDs use less power than comparable halogen lights.

### Easy Cleaning

No more permanent dirty marks with our EZKleen feature for stainless steel refrigerators. Anti-fingerprint coating means you simply wipe clean any marks. Spill-safe secure glass shelves easily capture any drips or leaks.

## SPECIFICATIONS

### Accessories (sold separately)

Door panel set stainless steel

RD3680AU  
(80"") or  
RD3684AU  
(84"")

Handle kit Classic	<b>AHCLRD36A</b>
Handle kit Contemporary round, aluminium	<b>AHS-ASBI-A</b>
Handle kit Contemporary square fine, aluminium	<b>AHD5RD36A</b>
Handle kit Contemporary square fine, black	<b>AHD5RD36AB</b>
Handle kit Professional round flush	<b>AHP3RD36A</b>
Water filter replacement	<b>847200 - FWC3</b>

Covered door shelves	<b>2</b>
Deli storage bins	<b>1</b>
Door alarm	<b>•</b>
Fruit and vegetable bins	<b>2</b>
LED lighting	<b>•</b>
Smart appliance	<b>•</b>
SmartTouch control panel	<b>•</b>
Stackable bottle holders	<b>4</b>
Ultra slim water dispenser	<b>•</b>
Water Filter	<b>Part number 842802</b>

**Power requirements**

Rated current	<b>10 A</b>
Supply frequency	<b>60 Hz</b>
Supply voltage	<b>115 V</b>

**Capacity**

Total gross capacity	<b>16.8 cu ft</b>
Volume	<b>16.8 cu ft</b>
Volume freezer	<b>5.1 cu ft</b>
Volume refrigerator	<b>11.7 cu ft</b>

**Freezer Features**

Automatic ice maker	<b>•</b>
Bottle chill	<b>•</b>
Door alarm	<b>•</b>
Fast freeze	<b>•</b>
Freezer bins	<b>1</b>
Ice Boost	<b>•</b>
LED Lighting	<b>•</b>
Slide Out Pastry Tray	<b>•</b>

**Product dimensions**

Depth	<b>23 3/4 "</b>
Height	<b>79 13/16 "</b>
Width	<b>35 1/16 "</b>

**Connected Features**

Alerts and notifications	<b>•</b>
Education and onboarding	<b>•</b>
Remote operation	<b>•</b>
Software updates	<b>•</b>

SKU 26316

The product dimensions and specifications in this page apply to the specific product and model. Under our policy of continuous improvement, these dimensions and specifications may change at any time. You should therefore check with Fisher & Paykel's Customer Care Centre to ensure this page correctly describes the model currently available. © Fisher & Paykel Appliances Ltd 2020

**Consumption**

Energy rating	<b>Energy Star</b>
Energy usage	<b>561kWh/year</b>
In-use energy carbon emissions estimate	<b>64.7kgCO2e/year</b>

**Performance**

ActiveSmart™ Foodcare	<b>•</b>
Adaptive defrost	<b>•</b>
Automatic defrost	<b>•</b>
Frost free freezer	<b>•</b>
Humidity control system	<b>•</b>
Sabbath mode	<b>•</b>

**Features**

Adjustable door shelves	<b>6</b>
Adjustable glass cantilevered shelves	<b>•</b>

**Other product downloads available at fisherpaykel.com**

- [↓ DXF](#)
- [↓ Archicad](#)
- [↓ Data Sheet \(English\)](#)
- [↓ DWG](#)
- [↓ DWG](#)
- [↓ Energy Label](#)
- [↓ Water Filter Replacement Instructions - Parts 847200 and 847201 \(English\)](#)
- [↓ Installation Guide \(English\)](#)

- [↓](#) Water Filter Replacement Instructions - Parts 847200 and 847201 (French)
- [↓](#) Installation Guide (Canadian French)
- [↓](#) Planning Guide (English)
- [↓](#) Revit
- [↓](#) Rhino
- [↓](#) Right To Repair Declaration (English, Canadian French)
- [↓](#) SketchUp
- [↓](#) User Guide (English)

**Where applicable:**

All appliances use energy, and energy usage typically generates carbon emissions. **Fisher & Paykel Appliances' In-use Energy Carbon Emissions Estimate** indicates carbon emissions from a product's in-use energy. This is calculated either annually or per cycle, using the product's market-specific energy label energy consumption data multiplied by the carbon emissions factor for energy in your country or region.

Our In-use Energy Carbon Emissions Estimate is designed to assist customers in making informed purchasing decisions when comparing different Fisher & Paykel products. For example, a heat pump dryer typically has a lower In-use Energy Carbon Emissions Estimate than a vented dryer.



**A PEACE OF MIND SALE**  
24 Hours 7 Days a Week Customer Support  
T 1.888.936.7872 W [www.fisherpaykel.com](http://www.fisherpaykel.com)