

**FISHER & PAYKEL**

**COMBI: GAS + INDUCTION COOKTOP**

---

**MINIMAL**

CGI905DNGTB, CGI905DLPTB4,  
CGI603DNGTB4, CGI603DLPTB4

**USER GUIDE**

**NZ AU**



## CONTENTS

---

Safety and warnings	4
First use	8
Safety features	9
Cookware	10
Using your burner	12
Using your induction zones	14
SmartZones	16
PowerBoost	18
GentleHeat	19
Auto RapidHeat	20
Using the timer	22
Cooking guide	24
Care and cleaning	27
Troubleshooting	30
Energy guidelines	34
Warranty and service	35

---

### Registration

To register your product visit our website: [fisherpaykel.com/register](https://fisherpaykel.com/register)

### ⚠ WARNING!



#### **Electrical Shock Hazard**

**Failure to follow this advice may result in electrical shock or death.**

- Switch the power to the cooktop off at the wall before cleaning or maintenance.
- Do not cook on a broken or cracked cooktop. If the glass should break or crack, turn off the gas supply and switch the appliance off immediately at the mains power supply (wall switch) and contact a qualified technician.

### ⚠ WARNING!



#### **Fire Hazard**

**Failure to follow this advice may result in serious injury.**

- Never leave the appliance unattended when in use. Boilover causes smoking and greasy spillovers that may ignite.
- Do not store items on cooking surfaces.

### ⚠ WARNING!



#### **Health Hazard**

**Failure to follow this advice may result in death.**

- This appliance complies with electromagnetic safety standards. However, persons with cardiac pacemakers or other electrical implants (such as insulin pumps) must consult with their doctor or implant manufacturer before using this appliance to make sure that their implants will not be affected by the electromagnetic field.

**⚠ WARNING!**



**Explosion Hazard**

**Failure to follow this advice may result in death or serious injury.**

- Do not use or store flammable materials such as gasoline near this appliance.
- Do not spray aerosols in the vicinity of this appliance while it is in operation.

**⚠ WARNING!**



**Hot Surface Hazard**

**Failure to follow this advice may result in serious injury.**

- This appliance becomes hot during use. Do not touch the cooktop components, burner, pan supports or the glass when hot.
- Never leave metal objects (such as kitchen utensils) or empty pans on the cooktop as they can become hot very quickly.
- Magnetisable metal objects worn on the body may become hot in the vicinity of the cooktop. Gold or silver jewellery will not be affected.

**⚠ WARNING!**



**Poisoning Hazard**

**Failure to follow this advice may result in poisoning or death.**

- Never use this appliance as a space heater to heat or warm the room. Doing so may result in carbon monoxide poisoning and overheating of the appliance.

### READ AND SAVE THIS GUIDE

#### **WARNING!**

To reduce the risk of fire, injury to persons or damage when using the appliance, follow the important safety instructions listed below. Read all the guidance before using the appliance.

#### General Use

- Never use your appliance as a work or storage surface.
- Wear proper apparel — Loose-fitting or hanging garments should never be worn while using the appliance.
- Do not place articles on or against this appliance.
- If the appliance is connected to the gas supply with a flexible hose, ensure that the hose cannot come in contact with the bottom of the appliance or any sharp edges.
- This appliance should be connected to a circuit that incorporates an isolating switch providing full disconnection from the electricity supply.
- Do not use an asbestos mat or decorative covers between the flame and the saucepan as this may cause serious damage to your cooktop.
- Do not place aluminium foil or plastic dishes on the cooktop burner.
- Do not let large saucepans, frying pans or woks push any other pans aside. This could make them unstable or deflect heat onto your benchtop and damage the surface.
- Saucepan handles may be hot to touch. Ensure saucepan handles do not overhang other cooking zones that are on. Keep handles out of reach of children.
- Never leave any objects or utensils on the appliance.
- Do not place or leave any magnetisable objects or electronic devices near the appliance, as they may be affected by its electromagnetic field.
- We recommend using plastic or wooden kitchen utensils for cooking with your induction cook surface.
- Flammable materials should not be stored in an oven or near surface units.
- Do not place or leave aluminum foil on the cooktop.
- Never use your appliance for warming or heating the room.
- Do not use water on grease fires. Smother fire or flames or use dry chemical or foam-type extinguisher.
- Moist or damp potholders on hot surfaces may result in burns from steam. Do not let potholder touch hot heating elements. Do not use a towel or other bulky cloth.
- This appliance is equipped with one or more surface units of different size. Always place small pans in the centre of the cooking zone.  
Select utensils having flat bottoms large enough to cover the surface unit heating element. The use of undersized utensils will expose a portion of the heating element to direct contact and may result in ignition of clothing. Proper relationship of utensil to burner will also improve efficiency.
- After use, always turn off the cooking zones and the cooktop as described in this guide. Do not rely on the pan detection feature to turn off the cooking zones when you remove the pans.
- Do not place or drop heavy objects on your cooktop.
- Do not stand on your cooktop.
- Do not use pans with jagged edges or drag pans across the ceramic glass surface as this can scratch the glass.
- Do not operate your cooktop by means of an external timer or separate remote-control system.
- Caution: The cooking process has to be supervised. A short term cooking process has to be supervised continuously.

## SAFETY AND WARNINGS

---

- Ensure the electrical connection is accessible after installation

### Child Safety

- Do not allow children to play with the appliance or sit, stand, or climb on it.
- Do not store items of interest to children in cabinets above the appliance. Children climbing on the cooktop could be seriously injured.
- Packing elements (eg plastic bags, polystyrene foam) should not be left around within easy reach of children, as these can cause serious injuries.
- Do not leave children alone or unattended in the area where the appliance is in use. Children of less than 8 years old must be kept away from the appliance unless continuously supervised. This appliance can be used by children aged from 8 years and above, and persons with reduced physical, sensory or mental capabilities or lack of experience and knowledge, if they have been given supervision or instruction concerning the use of the appliance in a safe way and they understand the hazards involved. Cleaning and user maintenance shall not be done by children without supervision.

### Cleaning

- Clean cooktop with caution — If a wet sponge or cloth is used to wipe spills on a hot cooking area, be careful to avoid steam burn. Some cleaners can produce noxious fumes if applied to a hot surface.
- Do not use a steam cleaner to clean your cooktop.
- Do not use scourers or any other harsh/abrasive cleaning agents to clean your cooktop, as these can scratch the ceramic glass.
- Before cleaning, turn the burner off and make sure the whole cooktop is cool.

### Servicing

- Do not modify this appliance.
- Do not repair or replace any part of the appliance unless specifically recommended in the user guide. All other servicing should be undertaken by a Fisher & Paykel trained and supported service technician or qualified person.
- If the power supply cable is damaged, it must only be replaced by a qualified technician.
- If the appliance is malfunctioning, it will display an alert code: first note down the alert code, then contact your Authorized Service Center or Customer Care to arrange for service. Do not use your appliance until it has been repaired by a Fisher & Paykel authorized technician.

### Standard Requirements

- This induction cooktop generates and uses ISM frequency energy that heats cookware by using an electromagnetic field. It has been tested and complies with Part 18 of the FCC Rules for ISM equipment. This induction cooktop meets the FCC requirements to minimize interference with other devices in residential installation. Induction cooktops may cause interference with television or radio reception. If interference occurs, the user should try to correct the interference by:
  - Relocating the receiving antenna of the radio or television
  - Increasing the distance between the cooktop and the receiver
  - Connecting the receiver into an outlet different than the receiver.

---

### WARNING!

**Do not place metal objects on top of the control panel when the cooktop is in use.**

# FIRST USE

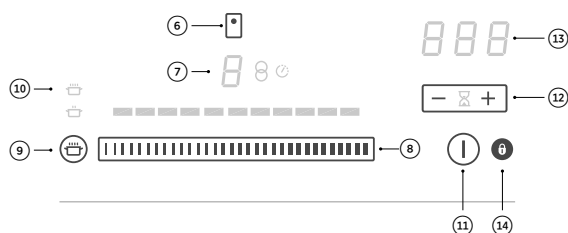
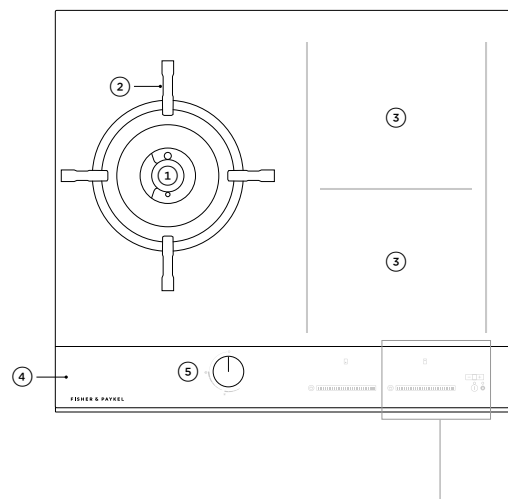

## Cooktop features

- ① Dual wok burner
- ② Pan support
- ③ Induction zones
- ④ Control panel
- ⑤ Burner dial
- ⑥ Zone indicator
- ⑦ Zone display
- ⑧ Zone heat selector
- ⑨ GentleHeat control
- ⑩ GentleHeat indicators
- ⑪ Cooktop ON/OFF
- ⑫ Timer control
- ⑬ Timer display
- ⑭ Keylock

Zone display	Description
	Cooking zone off (not activated)
	Cooking zone on (activated but not operating)
	Power levels
	PowerBoost feature
	Hot Surface indicator
	Pan detection indicator
	Bridged zone indicator
	Zone timer indicator

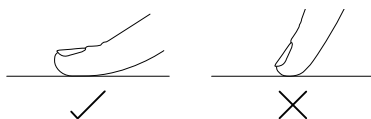

## Touch display

Your induction zones are operated using an intuitive touch display. Use the control panel to navigate cooking settings.

## Using the touch controls

Use the ball of your finger, not its tip. The controls respond to touch, so pressure is not needed.



## SAFETY FEATURES

---

The cooktop control dials can be locked for cleaning and to prevent unintended use. When the cooktop is locked the controls and cooktop display will remain unresponsive.



### LOCKING THE COOKTOP

Ensure all cooking zones have been turned to **OFF**. Touch and hold the keylock control  for 5 seconds. The indicator light above the control comes on, indicating that the controls are locked.



### UNLOCKING THE COOKTOP

To unlock the cooktop, touch and hold the keylock control  for 3 seconds. The indicator light above the control goes out. Your cooktop is now unlocked.

# COOKWARE

## Cookware size

For optimal performance, ensure the size of the cookware is suitable for the zone in use.

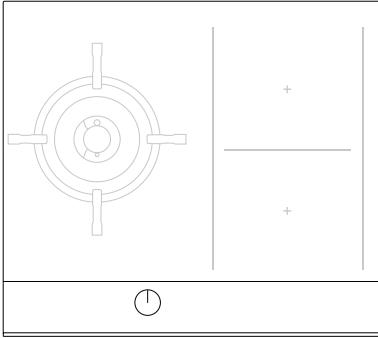

CGI1603DTB

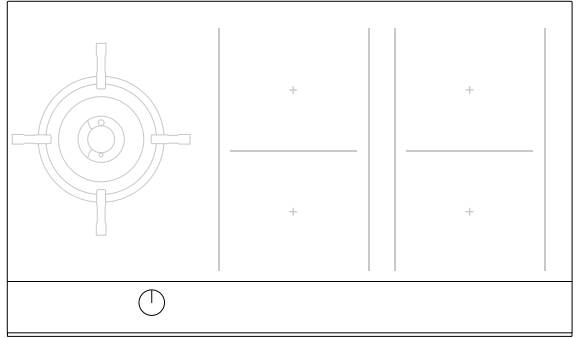

CGI905DTB

Cooking zone		Min. pan size*	max. pan size*
① Dual wok burner	without small pan support	200mm	340mm
	with wok stand	no minimum	400mm
② Smartzone	unbridged	120mm	no maximum
	bridged	250mm	no maximum

\* Recommended

# COOKWARE

## Induction cookware

The quality of your cookware can affect cooking performance. Only use induction-compatible cookware that has been specifically designed for induction cooking. Look for the induction symbol on the packaging or the bottom of the pan.

### Suitable cookware material:

- stainless steel – with a magnetic base or core
- aluminium and copper – with a magnetic base or core
- cast iron
- steel
- enamelled steel.

### Unsuitable cookware material:

- aluminium or copper – without a magnetic base
- glass
- wood
- porcelain
- ceramic or earthenware.

### To check if cookware material is suitable for induction use, carry out a magnet test:

Move a magnet across the base of the pan. If the magnet is attracted, the pan is induction suitable. Ensure attraction is consistent across the base of the pan. If there are gaps, such as an indented manufacturer's logo, then the performance will be impaired.

If you do not have a magnet, fill the pan with some water and refer to section 'Using your induction zones'. If  $\underline{U}$  does not flash and the water is heating, pan is suitable.

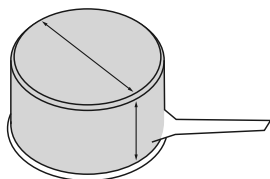

### Quickest heating Performance

High content of ferromagnetic material. Heating area is consistent across the base and up the sides of pan.

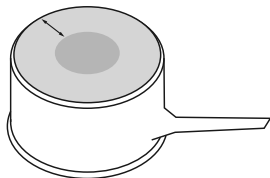

### Average heating Performance

Reduced area of ferromagnetic material. Reduced zone of heating, results in poor performance and slower heating.

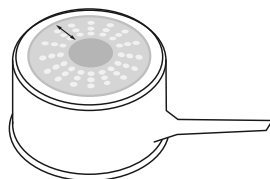

### Slow heating Performance

Very limited area of ferromagnetic material. Results in very slow heating performance.

Note: This type of pot is good for very delicate tasks such as melting chocolate, as heating is very slow.

Ensure the base of your cookware is smooth, sits flat against the glass, and is similar in size as the cooking zone. A small pot on a large cooking zone may not be detected. Always centre your pan on the cooking zone and lift pans off the cooktop – do not slide, or they may scratch the glass.

## USING YOUR BURNER

When using your burner, you can choose to use the inner burner only or both the inner and outer burners as desired.

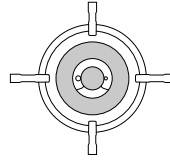

Inner and outer burners

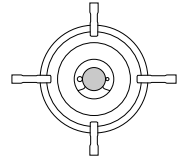

Inner burner only

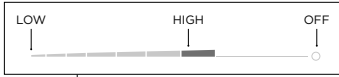

1

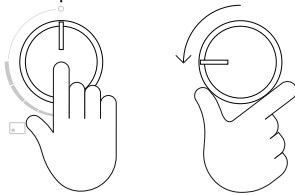

Push the dial down and turn counterclockwise to the highest heat setting. Once the burner is lit, hold the dial down for a further 3 seconds.

A clicking sound should be present when igniting the burner. If no clicking is present, turn the dial clockwise back to **OFF** and refer to 'Troubleshooting'.

2

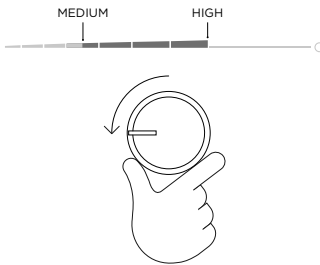

### Setting both the inner and outer rings

Turn the dial to any heat setting between **MEDIUM** and **HIGH** before releasing.

If the flame on the outer ring appears to flutter, turn the dial towards **HIGH** to stabilise.

3

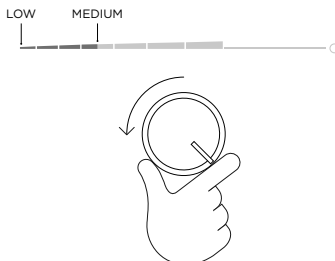

### Setting the inner ring

Turn the dial to any heat setting between **MEDIUM** and **LOW** before releasing.

## USING YOUR BURNER

### Manual lighting

If the burner will not light after several attempts, it can be manually lit. If you have attempted to light the burner with the ignition, allow 1 minute for any accumulated gas to dissipate before manually lighting.

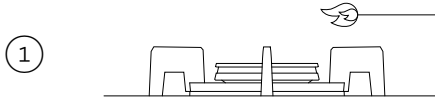

Carefully hold a lit match near the burner.

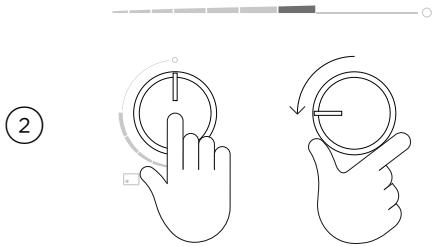

Push the dial down and turn counterclockwise to the highest heat setting. Once the burner is lit continue to hold the dial down for a further 3 seconds.

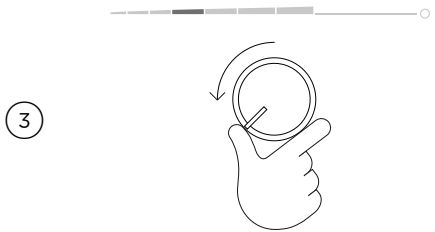

Wait until the flame is burning evenly before turning the dial to any heat setting between **HIGH** and **LOW** before releasing.

Do not set or leave the dial between **HIGH** and **O (OFF)**.

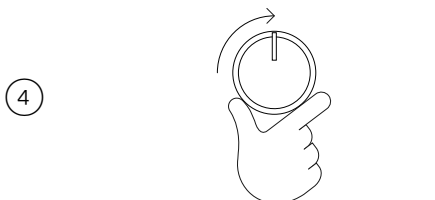

When you have finished cooking, turn the dial clockwise back to **O (OFF)**.

## USING YOUR INDUCTION ZONES

### To begin cooking

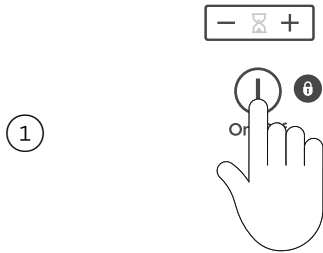

Touch and hold the **ON/OFF** control for 2 seconds. The indicator light above the control will glow.

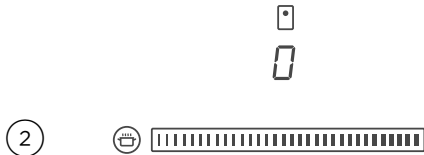

 will appear in the cooking zone display.

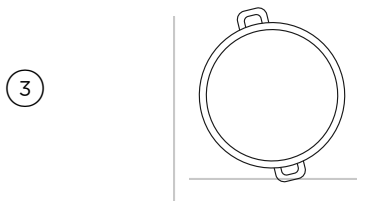

Place a suitable pan on the cooking zone.  
Ensure the bottom of the pan and the surface of the cooking zone are clean and dry.  
Always place small pans in the centre of the cooking zone.

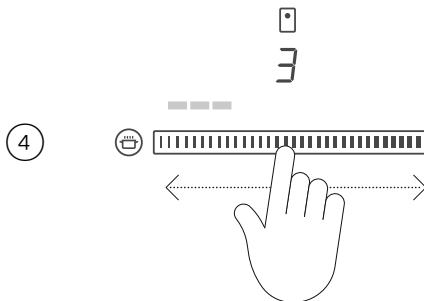

Select a heat setting by touching or sliding the setting selector with your finger.

- If you don't select a heat setting within 10 seconds, the cooktop will automatically turn off.
- You can modify the heat setting at any time during cooking.

## USING YOUR INDUCTION ZONES

---

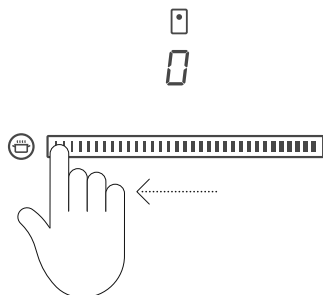

### Turn the cooking zone off:

Touch or slide the setting selector until  shows in the zone display.



### Turn the cooktop off:

touch the ON/OFF control.

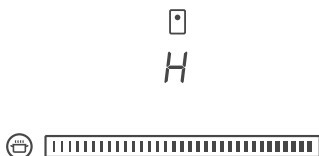

### If *H* flashes in the display:

*H* will flash in the cooking zone display of any zone that is too hot to touch. It will remain illuminated until it has cooled to a safe temperature.

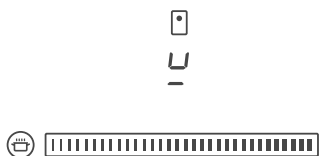

### If *U* flashes alternately with the heat setting:

the pan may not be located on the correct cooking zone, it may not be centred correctly or it may not be suitable for induction cooking.

No heating will take place until a suitable pan is detected. The cooktop will turn off after 10 minutes if no suitable pan is used.

## SMARTZONES

The SmartZones can accommodate several small pots. These small pots will be detected as one large pot.

The entire SmartZone is activated when a pot is detected. This means that other magnetic items (such as cutlery) sitting in the cooking zone will heat up. Do not leave cutlery or other magnetic items on your cooktop.

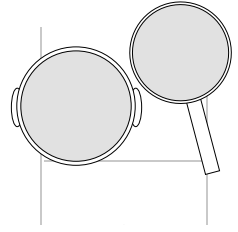

### Bridging Zones

The bridging zone function allows you to use two SmartZones together.

- You can only bridge a cooking zone with the one directly behind it.
- There may be a cooler area in the centre of the cooktop between the cooking zones. You may need to move food around the pan to ensure even cooking.
- When using bridging zones, it is not possible to use the PowerBoost function.

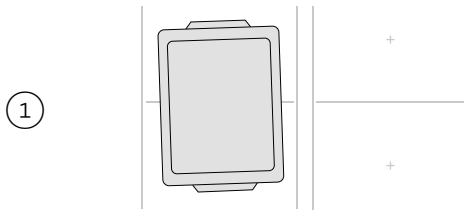

Place the pan over the two zones you wish to use, ensuring both zones are covered.

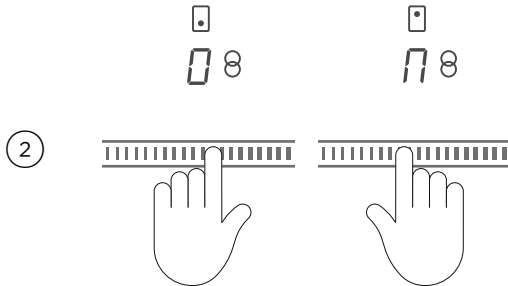

Touch anywhere on the setting selectors of both cooking zones at the same time.

8 will show in both control windows, 0 will show in the left hand display and 1 in the right hand display.

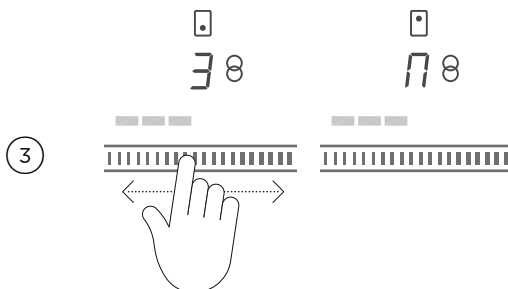

Use the left setting selector to set the heat setting for the combined zone.

The heat setting will be displayed in the left zone display while the right hand selector will show 1. The setting indicator will glow on both zones.



## SMARTZONES

---

### If no pan is detected on one cooking zone:

The left hand display will still show the selected temperature and the right hand display will still show  $\overline{1}$ .

### If after 10 minutes no pan is detected:

- The bridging function will switch off.
- The cooking zone without a detectable pan will turn off.
- The remaining cooking zone will continue cooking at the selected heat setting.

### To cancel bridging

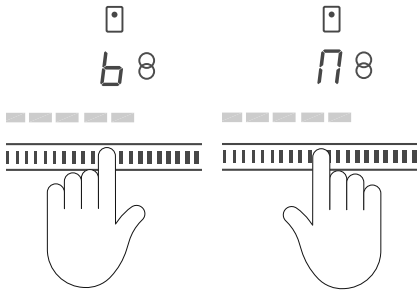

Touch the setting selectors of both bridged cooking zones at the same time. The bridging indicator lights will dim.

**Sliding the scale down to  $\overline{1}$  will not turn off bridging.**

### Using the timer in bridged mode:

You may only set one timer for the bridged cooking zone. See 'Using the timer'. The timer indicator  will show in both displays.

Cancelling bridging will also cancel the timer for those cooking zones.

# POWERBOOST

## Using PowerBoost

This feature enables you to sear meat or bring liquid to boil very quickly. When a cooking zone is set to PowerBoost, it uses more than 100% of the power of that particular cooking zone, resulting in a boost of intense heat. PowerBoost heats food and liquids very quickly. Do not leave the cooktop unattended when using this feature.

## Setting PowerBoost

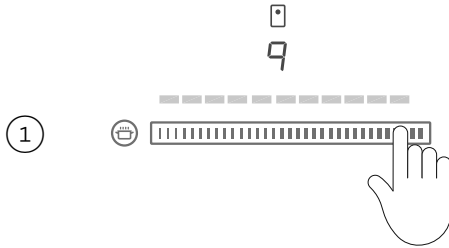

Slide the setting selector to set the cooking zone to the highest heat level. Hold until *P* displayed.

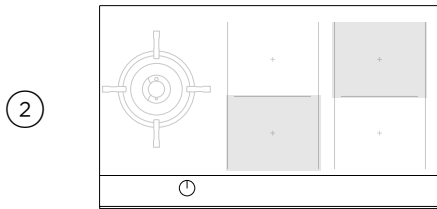

You can set one (CGI603 models) or two (CGI905 models) cooking zones for PowerBoost, as long as one is not behind the other.

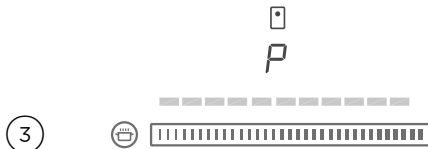

Once PowerBoost is set, the cooking zone will heat more than 100% for 10 minutes. *P* will flash for a few seconds before the cooking zone automatically reduces the heat to setting *9*.

- If one cooking zone is set to PowerBoost and a second cooking zone in front or behind the first cooking zone is accidentally set to PowerBoost, *P* will flash on the first cooking zone to alert that the configuration is not possible and power is automatically decreased.
- When a cooking zone is set for PowerBoost, the other cooking zone in front of or behind may automatically reduce its power level.
- PowerBoost is not available if cooking zones are bridged.



## To cancel PowerBoost

Slide the setting selector to a new heat setting or to *0* to turn off the zone.

# GENTLEHEAT

## Using GentleHeat

There are two GentleHeat settings.

- The Low setting  is ideal for the most delicate cooking tasks (such as melting chocolate), as the cooking zone will provide a very low continuous gentle heat.
- The Medium setting  is ideal for keeping cooked food warm and the gentle warming of delicate foods.

## Setting up a cooking zone for GentleHeat

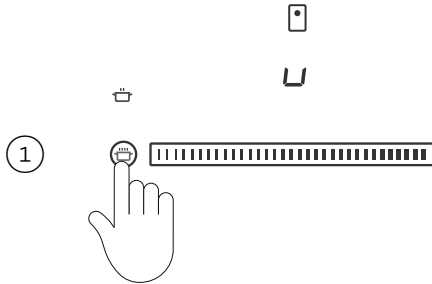

### For Low setting

Touch and hold the GentleHeat control on the setting selector.

The Low setting indicator above will glow and  will show in the display.

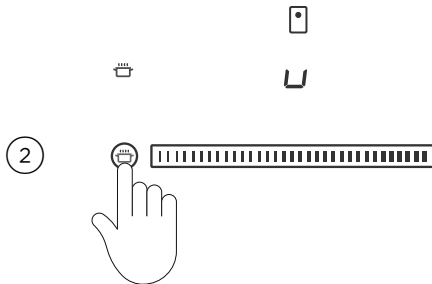

### For Medium setting

With cooking zone turned on, touch the GentleHeat control again to select the Medium setting.

- The Medium setting indicator above will glow and the Low setting indicator goes out.
- Touching the GentleHeat control a third time will switch off the cooking zone.

## To quit the GentleHeat setting

Touch or slide the setting selector to a new setting or to  to turn the cooking zone off.

# AUTO RAPIDHEAT

## Using Auto RapidHeat

This feature enables the cooking zones to:

- heat up food or liquid quickly at the highest setting, and
- reduce the temperature automatically to a pre-selected heat setting.

The amount of time the cooking zone will rapidly heat depends on the selected heat setting.

HEAT SETTING	APPROXIMATE TIME AT RAPID HEAT
1	40 seconds
2	1 minute
3	2 minutes
4	3 minutes
5	4 minutes
6	7 minutes
7	2 minutes
8	3 minutes

## Setting a cooking zone for Auto RapidHeat

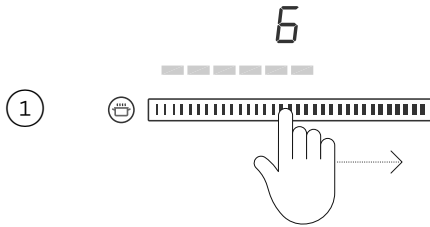

With cooking zone turned on, touch and slide the setting selector to the desired level of reduced heat for the cooking zone.

**Keep your finger on the selector.**

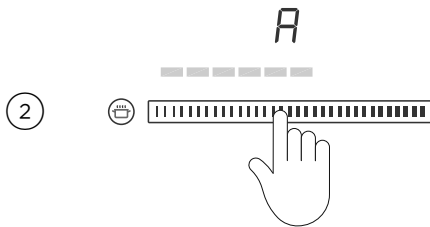

Hold your finger on the selector for 3 seconds until the letter *A* starts to flash alternately with the selected temperature.

- Lift up your finger once setting is complete.



Initially, while the cooking zone is at the highest setting, *A* will flash alternately with your selected lower setting. The length of time at the highest setting depends on the selected lower heat setting.

## AUTO RAPIDHEAT

---

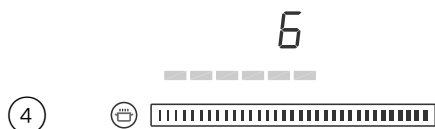

Then, when the period of highest setting is over,  $\bar{A}$  will stop flashing and the cooking zone will automatically reduce the heat to your pre-selected lower setting.

If you would like a lower or higher heat setting than you originally selected, simply slide to the new setting and hold until the  $\bar{A}$  starts flashing. Alternatively, wait until  $\bar{A}$  stops flashing and then modify the heat setting.

### To quit Auto RapidHeat setting while $\bar{A}$ is flashing

Either touch or slide the setting selector to a new setting or to  $\bar{0}$  to turn the cooking zone off.

**The Auto RapidHeat and PowerBoost features cannot be used together. If you turn PowerBoost on when Auto RapidHeat is already set, the Auto RapidHeat will cancel and PowerBoost will remain.**

## USING THE TIMER

You can set the timer for up to 1 hour and 59 minutes. The time will be displayed in hours and minutes when the timer is set for longer than 10 minutes.

### Using timer as minute minder

The minute minder can be set when not using any cooking zones. The cooktop will turn off after 20 seconds once the time has been set, but the timer will continue to count down.

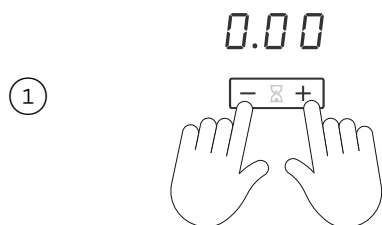

Ensure the cooktop is turned **ON**.

Touch the - and + controls together until **0.00** shows in the timer display and  is illuminated.

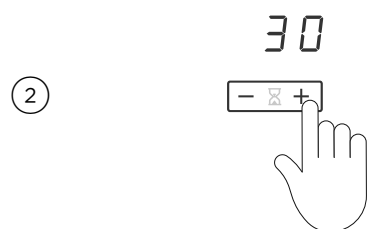

Set the time using the - and + controls. To scroll through the minutes faster, press and hold - or +. The time can be adjusted at any time during use.

#### When the set time is up

**0.00** will flash and the timer will beep. Touch the - or + controls to stop the beeping.

### Setting the timer for individual cooking zones.

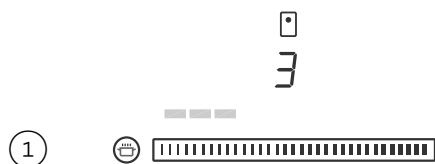

Ensure the cooking zone you want to set the timer for is in use.

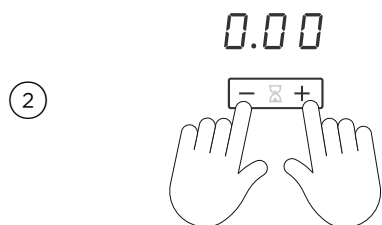

Tap the - and + controls together until the indicator of the desired cooking zone illuminates and set the time. Only the indicators of cooking zones in use will show as you scroll through.

## USING THE TIMER

### To cancel a timer setting

①

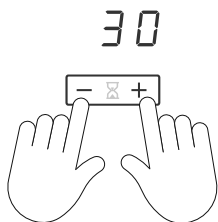

With the cooktop turned on, tap the - and + controls together until the indicator light in the desired cooking zone illuminates.

②

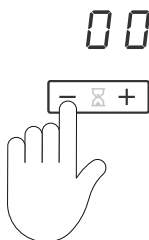



Press and hold the - control until the minute display shows 0. Scrolling down the time to 0 will not turn off the cooking zone.

When you have finished cooking, either touch or slide the setting selector to a new setting or to 0 to turn the cooking zone off.

### Setting different times for each of the cooking zones

#### Setting the minute minder when other timers are set

- ① Tap the - and + controls of the timer together as you cycle through the individual timers  for the cooking zones until  illuminates. 0.00 will show in the timer display.
- ② Touch the - and + controls to set the timer.

#### When the timer is set

If more than one timer is set, the cooking zone or minute minder indicator with the shortest remaining time setting will glow brightly. Other timer indicators will be dimly lit.

#### To check the remaining time for another cooking zone

Press the - and + controls together until the indicator in the desired cooking zone window glows brightly.

## COOKING GUIDE

---

**Take care when frying: oil and fat heat up very quickly, particularly if you're using PowerBoost. At extremely high temperatures oil and fat will ignite spontaneously and this presents a serious fire risk.**

### Cooking tips

- When food comes to the boil, reduce the temperature setting.
- Using a lid will reduce cooking times and save energy by retaining the heat.
- Minimize the amount of liquid or fat to reduce cooking times.
- Start cooking on a high setting and reduce the setting when the food has heated through.

### Simmering, cooking rice

- Simmering occurs below boiling point, at around 85°C, when bubbles are just rising occasionally to the surface of the cooking liquid. This is the key to delicious soups and tender stews because the flavours develop without overcooking the food. You should also cook egg-based and flour-thickened sauces below boiling point.
- Some tasks, including cooking rice by the absorption method, may require a setting higher than the lowest setting to ensure the food is cooked properly in the time recommended.

### Searing steak

To cook juicy flavoursome steaks:

- ① Stand the meat at room temperature for about 20 minutes before cooking.
- ② Heat up a heavy-based frying pan.
- ③ Brush both sides of the steak with oil. Drizzle a small amount of oil into the hot pan and then lower the meat onto the hot pan.
- ④ Turn the steak only once during cooking. The exact cooking time will depend on the thickness of the steak and how cooked you want it. Times may vary from about 2–8 minutes per side. Press the steak to gauge how cooked it is – the firmer it feels the more 'well done' it will be.
- ⑤ Leave the steak to rest on a warm plate for a few minutes to allow it to relax and become tender before serving.

### Stir-frying



When stir-frying be careful to lift the pan clear of the surface if tossing the ingredients. Sliding the pan across the cooktop surface may scratch it.

- ① Choose an induction compatible flat-based wok or a large frying pan.
- ② Have all the ingredients and equipment ready. Stir-frying should be quick. If cooking large quantities, cook the food in several smaller batches.
- ③ Preheat the pan briefly and add two tablespoons of oil.
- ④ Cook any meat first, put it aside and keep warm.
- ⑤ Stir-fry the vegetables. When they are hot but still crisp, turn the cooking zone to a lower setting, return the meat to the pan and add your sauce.
- ⑥ Stir the ingredients gently to make sure they are heated through.
- ⑦ Serve immediately.



## COOKING GUIDE

### Induction heat settings

HEAT SETTING	SUITABILITY
U	 <ul style="list-style-type: none"><li>melting chocolate, butter, and foods that burn quickly</li></ul>
	 <ul style="list-style-type: none"><li>delicate warming for small amounts of food</li></ul>
1 - 2	<ul style="list-style-type: none"><li>gentle simmering</li><li>slow warming</li></ul>
3 - 4	<ul style="list-style-type: none"><li>reheating</li><li>rapid simmering</li><li>cooking rice</li></ul>
5 - 6	<ul style="list-style-type: none"><li>pancakes</li></ul>
7 - 8	<ul style="list-style-type: none"><li>sautéing</li><li>cooking pasta</li></ul>
9	<ul style="list-style-type: none"><li>stir-frying</li><li>searing</li><li>bringing soup to the boil</li></ul>
P	<ul style="list-style-type: none"><li>boiling water</li></ul>

The settings below are guidelines only. The exact setting will depend on several factors, including your cookware and the amount you are cooking. Experiment with the cooktop to find the settings that best suit you.

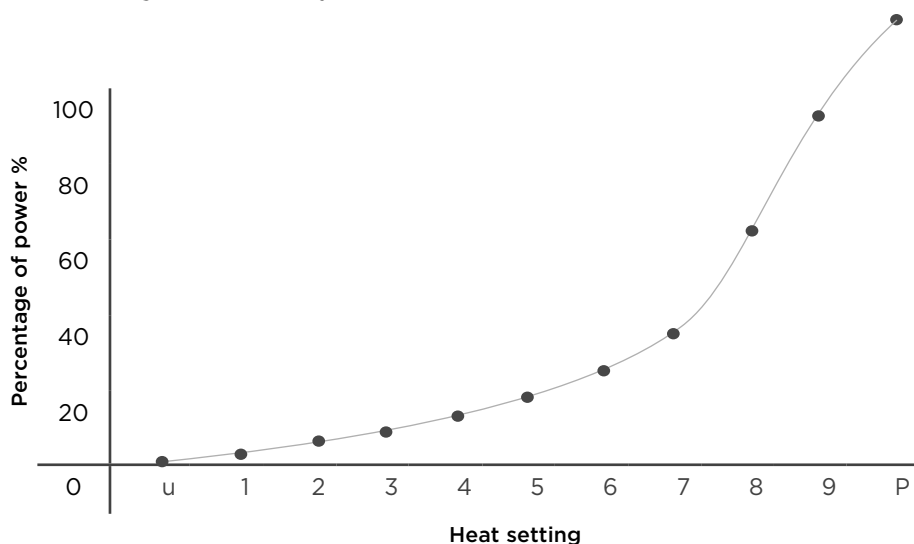

## Burner supports

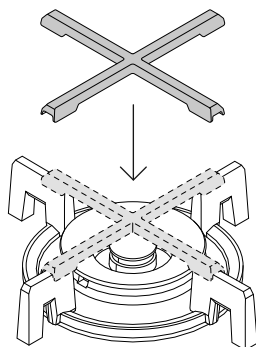

### Small pan support

The small pan support has been designed for supporting cookware with a base diameter smaller than 200mm.

### Using the small pan support

Ensure cooktop is cool before slotting the small pan support onto the centre of the dual wok burner as shown. Ensure all notches rest securely on the burner pan supports before use.

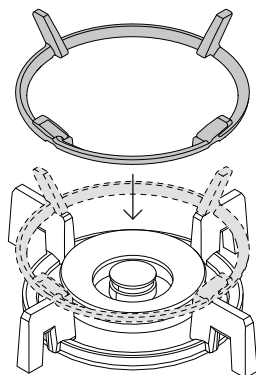

### Wok stand

The wok stand has been designed to allow the safe use of a wok. This accessory must be used when cooking with a wok.

### Using the wok stand

Ensure cooktop is cool before slotting the wok stand onto the centre of the dual wok burner as shown. Ensure all notches rest securely on the burner pan supports before use.

# CARE AND CLEANING

## Replacing burner parts

Ensure that all burner parts are correctly fitted. An incorrectly assembled burner may produce dangerous flames. Flames should be blue with no yellow tipping, and burn without fluttering around the burner cap.

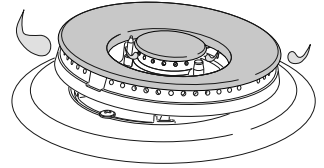
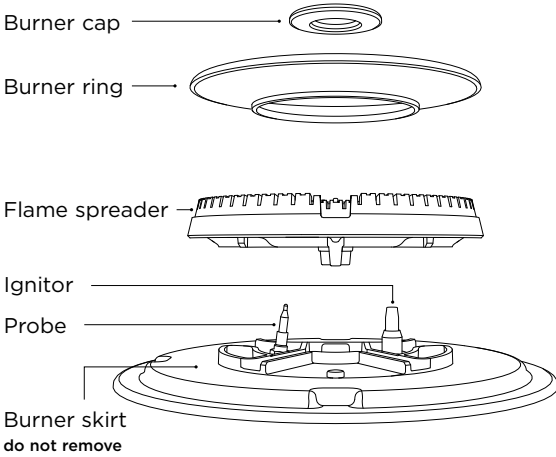

Incorrect alignment

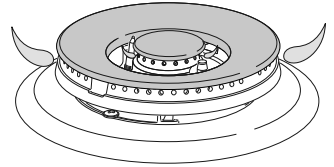

Correct alignment

## Pan supports

Locate the pan support to the three recesses on the burner skirt to secure.

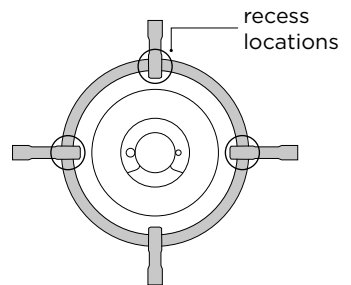
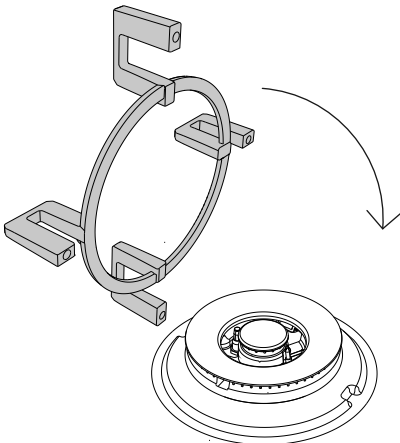

Plan view

## CARE AND CLEANING

---

### Burner

The burner should be cleaned regularly. Food residue may obstruct the ignitor and the notches of the flame spreader, preventing the burner from functioning correctly. Refer to 'Replacing burner parts' for details on safely removing and refitting burner parts.

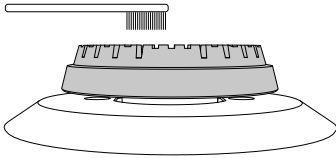

#### Burner caps, rings, flame spreaders and accessories

- ① Remove the parts that you wish to clean.
- ② Clean in hot soapy water with a stiff nylon brush, stubborn stains can be soaked in powdered dishwasher or laundry detergent. A straight end paperclip can also be used to clear any obstructions from the flame ports.
- ③ Rinse in warm water and dry thoroughly. Ensure all parts are completely dry before refitting as wet burner parts may result in an irregular flame.
- ④ Ensure all parts are replaced correctly.

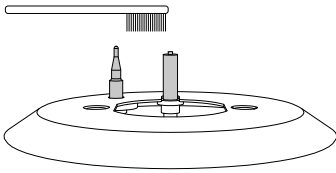

#### Ignitor and probe

- ① Remove the parts required to access the ignitor and probe.
- ② Clean carefully with a stiff nylon brush dipped in methylated spirits ensuring any build up is removed.
- ③ Ensure all parts are replaced correctly.

### All gas components

All checking and maintenance must be performed by a suitably qualified person. If the gas is connected with a flexible hose, checking should include inspecting the entire length of the flexible hose assembly for any sign of wear or damage.

## CARE AND CLEANING

WHAT?	HOW?	IMPORTANT!
Everyday soiling on glass (fingerprints, marks, stains left by food or non-sugary spillovers on the glass)	<ol style="list-style-type: none"><li>① Switch the power to the cooktop off at the wall.</li><li>② Apply cooktop cleaner while the glass is still warm (but not hot!)</li><li>③ Rinse and wipe dry with a clean cloth or paper towel.</li><li>④ Switch the power to the cooktop back on at the wall.</li></ol>	<ul style="list-style-type: none"><li>• When the power to the cooktop is switched off, there will be no 'hot surface' indication but the cooking zone may still be hot! Take extreme care.</li><li>• Heavy-duty scourers, some nylon scourers and harsh/abrasive cleaning agents may scratch the glass. Always read the label to check if your cleaner or scourer is suitable.</li><li>• Never leave cleaning residue on the cooktop: the glass may become stained.</li></ul>
Boilovers, melts, and hot sugary spills on the glass	<ol style="list-style-type: none"><li>① Remove these immediately with a fish slice, palette knife or razor blade scraper suitable for ceramic glass cooktops, but beware of hot cooking zone surfaces.</li><li>② Switch the power to the cooktop off at the wall.</li><li>③ Hold the blade or utensil at a 30° angle and scrape the soiling or spill to a cool area of the cooktop.</li><li>④ Clean the soiling or spill up with a dish cloth or paper towel.</li><li>⑤ Follow steps 2 to 4 for 'Everyday soiling on glass' above.</li></ol>	<ul style="list-style-type: none"><li>• Remove stains left by melts and sugary food or spillovers as soon as possible. If left to cool on the glass, they may be difficult to remove or even permanently damage the glass surface.</li><li>• Cut hazard: when the safety cover is retracted, the blade in a scraper is razor-sharp. Use with extreme care and always store safely and out of reach of children.</li></ul>
Spillover on the touch controls and stainless steel strip	<ol style="list-style-type: none"><li>① Switch the power to the cooktop off at the wall.</li><li>② Soak up the spill.</li><li>③ Wipe the touch control area with a clean damp sponge or cloth.</li><li>④ Wipe the area completely dry with a paper towel.</li><li>⑤ Switch the power to the cooktop back on at the wall.</li></ol>	<ul style="list-style-type: none"><li>• The cooktop may beep and turn itself off, and the touch controls may not function while there is liquid on them. Make sure you wipe the touch control area dry before turning the cooktop back on.</li></ul>







## TROUBLESHOOTING

### General

PROBLEM	POSSIBLE CAUSES	WHAT TO DO
The cooktop cannot be turned on.	No power.	Ensure the cooktop is connected to the power supply, that it is switched on at the wall and there is no power outage. If the problem persists, call your Authorised Service Centre or Customer Care.
The glass is being scratched.	Rough-edged cookware.	See 'Cookware'.
	Unsuitable, abrasive scourer or cleaning products being used.	See 'Care and cleaning'.
The glass surface of the cooktop has chipped or cracked.		Contact Customer Care and do not use your cooktop until it has been repaired.
Fan noise coming from the cooktop.	A cooling fan built into your cooktop has come on to prevent the electronics from overheating. It may continue after the cooktop is turned off.	This is normal and needs no action. Do not switch the power to the cooktop off at the wall while the fan is running.
Condensation is forming on surrounding walls, cabinetry or your overhead rangehood.	This is a normal for induction cooking.	<p>This is normal and does not indicate a fault.</p> <p>To minimise condensation:</p> <ul style="list-style-type: none"> <li>• Ensure adequate ventilation while cooking.</li> <li>• Switch your rangehood on 5 minutes before cooking and let it run for at least 5 minutes after cooking.</li> <li>• Use your rangehood on a lower speed when boiling.</li> <li>• Use the cooktop on a lower heat setting when boiling.</li> <li>• Use pot lids to stop moisture from escaping.</li> <li>• If condensation forms, wipe walls and cabinetry.</li> </ul>
	<p>Energy efficient technology means that no heat is lost to surrounding surfaces.</p> <p>This results in condensation forming on these cooler surfaces when steam is produced by cooking.</p>	

## TROUBLESHOOTING

### Induction zones

PROBLEM	POSSIBLE CAUSES	WHAT TO DO
The touch controls are unresponsive.	The controls are locked.	Unlock the controls. Refer to 'Safety features'.
The touch controls are difficult to operate.	There may be a slight film of water over the controls or you may be using the tip of your finger when touching the controls.	Ensure the touch control area is dry and use the ball of your finger when touching the controls.
Some or all displays flash  and there is a continuous beep.	Liquid has spilled onto the touch control area.	Switch the power to the cooktop off at the wall and see 'Care and cleaning' for instructions.
	There are objects on the touch control area.	Remove the objects from the touch control area.
	Several touch controls are registering continuous contact (due to someone resting their hand or arm on the touch control area for example).	Remove the cause of continuous contact.
Pans do not become hot and  appears in the display.	The cooktop cannot detect the pan because it is not suitable for induction cooking.	Use cookware suitable for induction cooking. See section 'Cookware'.
	The cooktop cannot detect the pan because it is too small for the cooking zone or not properly centred on it.	Centre the pan and make sure that its base matches the size of the cooking zone.
Pans do not become hot. The heat setting display comes on, but  does not flash.  shows in the timer display when I turn on the cooktop.	The cooktop is in Display mode.	Contact Customer Care or your Authorised Service Centre.
The cooktop or cooking zone has turned itself off, a tone sounds and an error is displayed (typically  or  )	This indicates a technical fault.	Note down the code, switch the power to the cooktop off at the wall, and contact your Authorised Service Centre or Customer Care with the error code information.

## TROUBLESHOOTING

PROBLEM	POSSIBLE CAUSES	WHAT TO DO
Some pans make crackling or clicking noises.	This may be caused by the construction of your cookware (layers of different metals vibrating differently).	This is normal for induction cookware and does not indicate a fault.
The cooktop makes a low humming noise when used on a high heat setting (especially PowerBoost).	This is caused by the technology of induction cooking.	This is normal, but the noise should quieten down or disappear when the heat setting is decreased.
Fan noise coming from the cooktop.	A cooling fan built into your cooktop has come on to prevent the electronics from overheating. It may continue to run even after you've turned the cooktop off.	This is normal and needs no action. Do not switch the power to the cooktop off at the wall while the fan is running.
I have locked the control panel while two cooking zones are bridged and the cooktop has not turned off.	This is normal. The cooking zones will remain inactive, but the indicator lights will remain on.	Unlock the controls, deactivate the bridging zones and then lock the cooktop again Refer to 'SmartZones'.
<b>P</b> flashes in the display when you are trying to set PowerBoost.	PowerBoost is temporarily unavailable because the cooktop needs to protect itself from overheating.	Allow the cooktop to cool down.

### Gas burner

PROBLEM	POSSIBLE CAUSES	WHAT TO DO
The flames are yellow or yellow-tipped rather than blue.	<p>Burner parts may be clogged or wet.</p> <p>The cooktop may have been connected to the wrong gas type or the gas pressure is not correct.</p>	<p>Check that they are clean and dry, refer to 'Care and cleaning' for advice.</p> <p>Contact Customer Care and do not use your cooktop until it has been checked by a trained and supported service technician.</p>
The flame pattern is uneven around the burner.	<p>Burner parts may be clogged or wet.</p> <p>Burner parts may not have been replaced correctly.</p>	<p>Check that they are clean and dry. Refer to 'Care and cleaning' for advice.</p> <p>Check the assembly and ensure the burner cap and/or ring is sitting flat on the flame spreader. See 'Care and cleaning' for details.</p>
There is a strong gas smell.	The gas connection could be leaking.	Open a window and refer to your installation guide for details on checking for leaks. Do not use the until leak has been repaired.



## TROUBLESHOOTING

PROBLEM	POSSIBLE CAUSES	WHAT TO DO
<p>The flames are too large, or too small.</p> <p>The flames are noisy.</p> <p>The flames lift.</p>	<p>The cooktop may have been connected to the wrong gas type.</p>	<p>Contact Customer Care and do not use your cooktop until it has been checked by a qualified technician.</p>
<p>There is a slight rubbery or metallic smell when I use the cooktop for the first time.</p>	<p>This is normal for first use and is caused by manufacturing residues burning off.</p>	<p>The smell will disappear with use.</p>
<p>There is no clicking/sparking.</p>	<p>There is a power failure.</p> <p>The ignitor may be dirty.</p>	<p>You can still use your cooktop. Refer to 'Manual lighting' for details.</p> <p>Refer to 'Care and cleaning'.</p>
<p>There is clicking/sparking, but burner won't light easily or at all.</p>	<p>The gas supply may not be turned on at the valve or gas bottle.</p> <p>The gas supply to the house may not be working.</p> <p>Burner parts may be clogged or wet.</p> <p>Burner parts may not have been replaced correctly.</p>	<p>Turn the burner off, and check whether the gas supply to the cooktop is turned on. Wait 1 minute, then try relighting the burner, holding the dial down for a few more seconds. If the burner still doesn't light, check other possible causes below.</p> <p>You should hear the gas when you turn a burner on. If you use bottled gas, this may indicate you are getting near the end of the bottle and need to replace it.</p> <p>Ensure parts are clean and dry. See 'Care and cleaning' for guidance.</p> <p>Check the assembly and ensure the burner cap is sitting flat. See 'Replacing burner parts' for details.</p>
<p>The burner goes out after lighting.</p>	<p>Dial not held down long enough.</p>	<p>Wait 1 minute, then try relighting the burner, holding the dial down for a few more seconds.</p>
<p>The flame has been extinguished.</p>	<p>Blown out by draught.</p> <p>Extinguished by a spill.</p>	<p>The flame failure protection will automatically cut the gas supply to the burner off, stopping gas from escaping.</p> <p>Turn the burner off, then wait for at least 1 minute before attempting to relight. This is to allow for any accumulated gas to disperse.</p>
<p>The flame goes out at low settings.</p>	<p>The gas supply pressure may be low.</p>	<p>Check this with your installer.</p>

## ENERGY GUIDELINES

---

This cooktop has been designed and constructed in accordance with the following codes and specifications:

### In New Zealand and Australia:

- AS/NZS 60335-1:2011 General Requirements for Domestic electrical appliances
- AS/NZS 60335-2-6:2014 Particular Requirements for Domestic electrical cooking appliances
- AS/NZS CISPR 14.1:2013 Electromagnetic Compatibility Requirements.
- AS/NZS 5263.0:2017 General Requirements for Domestic gas appliances
- AS/NZS 5263.1.1:2016 Particular requirements for Domestic gas cooking appliances

### In Europe:

Safety requirements of EEC Directive “Low voltage” 2014/35/EU:

- EN 60335-1 General Requirements for Domestic electrical appliances
- EN 60335-2-6 Particular Requirements for Domestic electrical cooking appliances

Safety requirements of EEC Directive “EMC” 2014/30/EU:

- EN 55014-1, EN 55014-2, EN 61000-3-2, EN 61000-3-3 Electromagnetic Compatibility Requirements.

### Requirements of EEC Directive 93/68/EEC and 2011/65/EU

#### European directive 2012/16/EU on Waste Electrical and Electronic Equipment (WEEE) (for European Union countries only)

GB This appliance is marked according to the European directive 2012/19/EU on Waste Electrical and Electronic Equipment (WEEE). By ensuring this product is disposed of correctly, you will help prevent potential negative consequences for the environment and human health, which could otherwise be caused by inappropriate waste handling of this product.

The symbol  on the product, or on the documents accompanying the product, indicates that this appliance may not be treated as household waste. Instead it shall be handed over to the applicable collection point for the recycling of electrical and electronic equipment. Disposal must be carried out in accordance with local environmental regulations for waste disposal. For more detailed information about treatment, recovery and recycling of this product, please contact your local city office, your household waste disposal service or the shop where you purchased the product.

## WARRANTY AND SERVICE

---

### Before you call for service or assistance

Check the things you can do yourself. Refer to the installation instructions and your user guide and check that:

- ① Your product is correctly installed.
- ② You are familiar with its normal operation.

If after checking these points you still need assistance or parts, please refer to the Service & Warranty book for warranty details and your nearest Authorized Service Centre, Customer Care, or contact us through our website [www.fisherpaykel.com](http://www.fisherpaykel.com).

### Complete and keep for safe reference:

Model \_\_\_\_\_

Serial No. \_\_\_\_\_

Purchase Date \_\_\_\_\_

Purchaser \_\_\_\_\_

Dealer \_\_\_\_\_

Suburb \_\_\_\_\_

Town \_\_\_\_\_

Country \_\_\_\_\_

**FISHERPAYKEL.COM**

© Fisher & Paykel Appliances 2020. All rights reserved.

The models shown in this guide may not be available in all markets  
and are subject to change at any time.

The product specifications in this guide apply to the specific products and  
models described at the date of issue. Under our policy of continuous product  
improvement, these specifications may change at any time.

For current details about model and specification availability in your country,  
please go to our website or contact your local Fisher & Paykel dealer.

**516435A 10.20**