

Oven, 60cm, 16 Function, Self-cleaning

Series 9 | Contemporary

Stainless Steel



A highlight of the Fisher & Paykel collection, this Series 9 oven with touchscreen guided cooking helps to ensure every dish is cooked to perfection.

- Touchscreen guided cooking capability offers helpful tips for different food types as well as full recipes
- 85L total capacity, with 16 oven functions including Pastry Bake, Roast, Air Fry and Dehydrate
- Moisture level control with ActiveVent technology
- Pyrolytic self-cleaning function breaks down food residue for an easy clean

DIMENSIONS

Height	598mm
Width	596mm
Depth	565mm

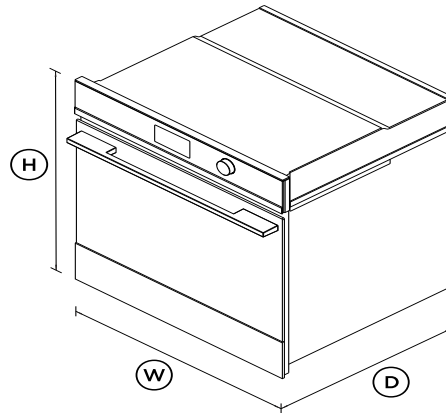

FEATURES & BENEFITS

Cook with confidence

Using the large 5" touchscreen interface, you can cook with a favourite method, a hero ingredient, or a go-to cooking function or recipe. Your oven will guide you through the steps, or change the temperature and heat type automatically, depending on your selection.

Generous capacity

With a generous 85L total capacity, you can create several

perfectly cooked dishes at once using multiple shelves. Non-tip, full-extension shelves help to ensure safe removal of hot dishes.

Exceptional performance

Our unique cooking technologies were developed to deliver perfect results. ActiveVent ensures optimised moisture levels, while AeroTech™ circulates heat evenly for a consistent temperature.

Safe And Sound

The CoolTouch door of this built-in oven is safe to touch from the outside. Sturdy, fully extendable shelves slide all the way out, reducing the need for you to reach inside.

Self-Cleaning

Pyrolytic self-clean breaks down food residue at a very high temperature, leaving a light ash that's easily removed with a damp cloth. The enamel coated side racks don't need to be removed when using this function.

Design freedom

Designed to fit seamlessly into your kitchen, this built-in oven features premium materials and detailing to support a cohesive, considered kitchen design.

Multi-Function Flexibility

Each function has been tailored, tested and perfected to ensure that no matter what you're cooking, you've got the right heat to match. A Wireless Temperature Sensor precisely monitors cooking in real time, giving you complete control.

SPECIFICATIONS

Accessories

Flat brushed baking tray	1
Full extension sliding shelves	1 set
Grill rack	1 set
Pyrolytic proof shelf runners	•
Roasting dish	1

Smokeless grill tray	1
Step down wire shelf	1
Wired temperature sensor	1

Capacity

Shelf positions	6
Total capacity	85L
Usable capacity	72L

Cleaning

Acid resistant graphite enamel	•
Pyrolytic proof shelf runners	•
Pyrolytic self-clean	•
Removable oven door	•
Removable oven door inner	•
Removable shelf runners	•

Controls

Adjustable audio and display	•
Audio feedback	•
Automatic cooking/minute	•
Automatic pre-set	•
Celsius/Fahrenheit	•
Certified Sabbath mode	•
Delay start	•
Electronic clock	•
Electronic oven control	•
Food probe	•
Guided cooking by food type	•
Halogen lights	•

Intuitive touchscreen display	•
Multi-language display	UK English, US English,
Soft close doors	•
True convection oven	•

Functions

Air fry	•
Bake	•
Classic bake	•
Dehydrate	•
Fan bake	•
Fan forced	•
Fan grill	•
Grill	•
Number of functions	16
Pastry Bake	•
Pizza bake	•
Pyrolytic self-clean	•
Rapid proof	•
Roast	•
Slow cook	•
Vent bake	•
Warm	•

Performance

ActiveVent System	•
AeroTech Technology	•
Automatic rapid pre-heat	•
Grill power	3000W
Temperature range	35°C - 280°C

Whisper quiet cooking	•
-----------------------	---

Power requirements

Amperage	15A
Supply frequency	50Hz
Supply voltage	220 - 240V

Product dimensions

Depth	565mm
Height	598mm
Width	596mm

Safety

Balanced oven door	•
Catalytic venting system	•
Control panel key lock	•
CoolTouch door	•
Non-tip shelves	•
Safety thermostat	•







Warranty

Parts and labour	1 year
------------------	--------

SKU	82522
-----	-------

The product dimensions and specifications in this page apply to the specific product and model. Under our policy of continuous improvement, these dimensions and specifications may change at any time. You should therefore check with Fisher & Paykel's Customer Care Centre to ensure this page correctly describes the model currently available. ? Fisher & Paykel Appliances Ltd 2020

Other product downloads available at fisherpaykel.com

-  [Service & Warranty](#)
-  [User Guide Oven EN](#)
-  [User Guide Oven ZH](#)
-  [🔒 ZH](#)
-  [Datasheet Oven](#)
-  [Preliminary Specification Guide Wall Oven](#)



A PEACE OF MIND SALE

24 Hours 7 Days a Week Customer Support

T 400 640 8777 W www.fisherpaykel.com