

Integrated Dishwasher, Sanitise

Series 5 | Integrated

Panel Ready



Designed to be integrated seamlessly into your cabinetry, this dishwasher delivers extra wash options and Auto Door Open Dry.*

- Customise with your own front panel and handle to match your kitchen cabinetry
- Seven wash programs from Heavy to Light, including Auto and 60min
- Dry+, Sanitise and Half Load modifiers provide extra wash options
- Wi-Fi enabled and works with the SmarthQ™ app for remote control and notifications

DIMENSIONS

Height	820 - 880mm
Width	598mm
Depth	554mm

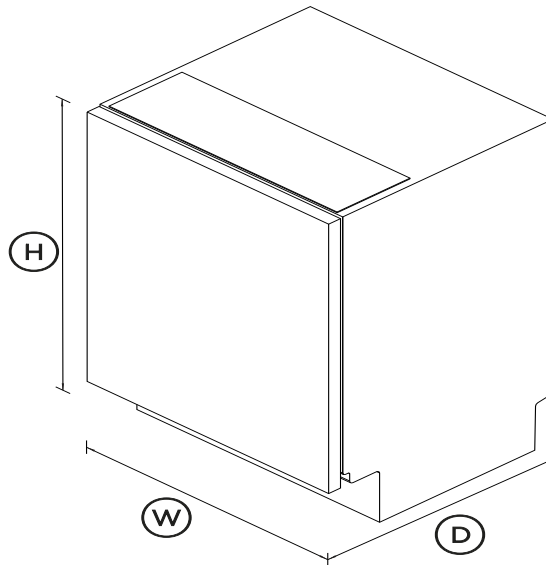

FEATURES & BENEFITS

Seamless Integration

Customise your dishwasher with a panel and handle matching your cabinetry, for a seamless finish in your kitchen.

Effortless Drying

For beautifully dry dishes every time, this dishwasher features an advanced drying system. It combines fan-assisted drying with an automatic door opening at the cycle's end. The Auto Door Open Dry feature releases excess steam, ensuring dishes are

immediately ready for use or storage. An innovative air curtain channels the steam away from the adjacent benchtop, protecting your cabinetry.

A RELIABLE CLEAN

This dishwasher offers seven wash programs including Auto, which automatically senses the optimal wash settings for your dishes. The three-stage filtration system delivers a superior clean, while the rinse aid indicator reminds you to top up for beautifully clean dishes.

Customise Your Wash

The Half Load modifier is perfect for washing a partial load, for faster turnaround of dishes. Sanitise provides extra protection, killing 99.9% of bacteria* in the final rinse, while the Dry+ modifier is great for plastic dishes. *Certified to NSF/ANSI Standard 184

Efficient Performance

With a 4 star energy rating and 5 star water rating, this dishwasher delivers a powerful wash. Use the Eco wash program for optimal water and energy consumption, or choose when the cycle begins with Delay Start.

Flexible Loading

Designed to fit 15 place settings with ease, adjustable racks help you to load and care for various items – including a height-adjustable upper basket, and foldable cup holders and tines.

SPECIFICATIONS

Accessories

- Cutlery basket
- Kickstrip

Accessories (sold separately)

Door panel black stainless steel	ADDW60PB
Door panel stainless steel	ADDW60PX

Handle kit Contemporary	AHS-OBDD-60S
Handle kit Contemporary	AHD5-OBDD-60SX
Handle kit Contemporary	AHD5-OBDD-60SB
Handle kit Contemporary	AHD3-OBDD-60S
Handle kit Contemporary	AHD3-OBDD-60B
Handle kit Professional round	AHP3-DWDD-60S

Capacity and loading

Accommodates round plates	320mm
Accommodates round plates	250mm
Adjustable height, foldable	•
Easy lift adjustable upper	•
Fold down tines	•
Place settings	15

Consumption

Energy rating	4 star
Energy usage	246kWh/year
In-use energy carbon	33.3kgCO2e/year
Water consumption (per wash	12.2L
Water efficiency	5 star (WELS)

Controls

Energy saving delay start	•
Intuitive capacitive touch	•
Keylock	•
Rinse aid indicator light	•
Wi-Fi connectivity	•

Features

Air curtain for bench	•
Aquastop	•
Auto Door Open Dry	•
Flood protection	•
Fully independent spray arms	•
Internal tub material	Stainless Steel
Motor type	Asynchronous
ThermoDry system	•
Three-stage filtration system	•

Performance

Noise emissions	46dBA
-----------------	--------------

Power requirements

Amperage	10A
Supply frequency	50Hz
Supply voltage	220 - 240V

Product dimensions

Depth	554mm
Height	820 - 880mm
Width	598mm

Warranty

Parts and labour	2 years
------------------	----------------

Wash Program Modifiers

Dry +	•
Half-load	•
Sanitise	•

Wash modifiers	3
----------------	----------

Wash Programs

60 min	•
Auto	•
Eco	•
Heavy	•
Light	•
Medium	•
Rinse	•
Wash programs	7

Water connection

Water pressure	30kPa - 1000 kPa
Water supply	3/4" BSP (20mm) Connector

SKU	82431
-----	-------

The product dimensions and specifications in this page apply to the specific product and model. Under our policy of continuous improvement, these dimensions and specifications may change at any time. You should therefore check with Fisher & Paykel's Customer Care Centre to ensure this page correctly describes the model currently available. Fisher & Paykel Appliances Ltd 2020







Where applicable:

All appliances use energy, and energy usage typically generates carbon emissions. **Fisher & Paykel Appliances' In-use Energy Carbon Emissions Estimate** indicates carbon emissions from a product's in-use energy. This is calculated either annually or per cycle, using the product's market-specific energy label energy consumption data multiplied by the carbon emissions factor for energy in your country or region.

Our In-use Energy Carbon Emissions Estimate is designed to assist customers in making informed purchasing decisions when comparing different Fisher & Paykel

products. For example, a heat pump dryer typically has a lower In-use Energy Carbon Emissions Estimate than a vented dryer.

Other product downloads available at fisherpaykel.com

-  [Service & Warranty](#)
-  [User Guide Dishwasher](#)
-  [Wash Program Data Dishwasher](#)
-  [Energy & Water Label](#)
-  [Installation Guide Built-Under Dishwasher](#)
-  [Door Template](#)



A PEACE OF MIND SALE

24 Hours 7 Days a Week Customer Support

T 0800 372 273 W www.fisherpaykel.com