

FISHER & PAYKEL

BOX WALL RANGEHOOD

CONTEMPORARY

HC60DCXB4, HC90DCXB4, HC90DCBB4 & HC120DCXB4

INSTALLATION GUIDE

NZ AU

⚠ WARNING!



Electric Shock Hazard

Failure to follow this advice may result in electric shock or death.

- Installation and electrical wiring must be completed by qualified person(s) in accordance with all applicable codes and standards, including fire-rated construction.
- Always disconnect the appliance from the mains power supply before carrying out any maintenance or repairs.

⚠ WARNING!



Weight Hazard

Failure to follow this advice may result in damage or personal injury.

- The appliance is heavy. Please ensure adequate care is taken when installing the appliance.
- The appliance must be installed onto a solid wall, stud, beam or truss.
- **Product weight:** 6.4kg (HC60) and 8.4kg (HC90).

⚠ WARNING!



Cut Hazard

Failure to use caution could result in injury.

- Take care: some edges are sharp.
- Wear gloves to protect against sharp edges.

READ AND SAVE THESE INSTRUCTIONS

WARNING!

When using this appliance always exercise basic safety precautions including the following:

Installation

- Please read the entire set of instructions before installing or using this appliance.
- Please make this information available to the person installing the appliance - doing so could reduce your installation costs.
- Always switch the power off prior to installation, servicing or cleaning of the appliance.
- This appliance must be installed and connected to the mains power supply only by a suitably qualified person according to these installation instructions and in compliance with any applicable local building and electricity regulations. Failure to install the appliance correctly could invalidate any warranty or liability claims.
- To comply with electrical safety regulations, the appliance must be plugged into a socket near the appliance. The socket must be accessible, or have an accessible isolating switch, to enable the end user to isolate the appliance from the power for the purpose of internal cleaning or maintenance.
- A power outlet should be within 750 mm of the motor assembly and can either be on the wall, behind the chimney or in the ceiling.
- If the supply cord of this equipment is damaged, it must only be replaced by the manufacturer, its service agent or similarly qualified person in order to avoid a hazard.
- Ducting accessories are not supplied. All ducting must comply with local requirements and building codes.
- Attention should be given to ensure that any applicable regulations concerning the discharge of exhaust air are fulfilled.
- Before connecting any pipes, consult municipal ordinances to ensure that any applicable regulations concerning the discharge of exhaust air are adhered to and request permission from the person in charge of the building.
- Exhaust air must not be discharged into an existing flue that is used for exhausting fumes from appliances burning gas or other fuels.
- There shall be adequate ventilation of the room when the rangehood is used at the same time as appliances burning gas or other fuels.
- For Australia and New Zealand: Range hoods and other cooking fume extractors may adversely affect the safe operation of appliances burning gas or other fuels (including those in other rooms) due to back flow of combustion gases. These gases can potentially result in carbon monoxide poisoning. After installation of a range hood or other cooking fume extractor, the operation of flued gas appliances should be tested by a competent person to ensure that back flow of combustion gases does not occur.
- The minimum distance between the supporting surface for cooking vessels on the cooktop and the lowest part of the rangehood shall be 600 mm if installed over a gas or electric cooktop.
- Stainless steel is very easily damaged during installation if abraded or knocked by tools. It is recommended to protect the top of the rangehood with cardboard or polystyrene during the installation to minimise the risk of damage occurring.
- To reduce the risk of damage occurring to the cooktop, it is recommended that the surface of the cooktop is protected with cardboard or a similar object during installation of the rangehood.
- This appliance is not intended for use by persons (including children) with reduced physical, sensory or mental capabilities, or lack of experience and knowledge, unless they have been given supervision or instruction concerning the use of the appliance by a person responsible for their safety.
- Children should be supervised to ensure they do not play with the appliance. Cleaning and user maintenance shall not be made by children without supervision.
- You must read the details concerning the method and frequency of cleaning.
- There is a fire risk if cleaning is not carried out in accordance with the instructions.

SAFETY AND WARNINGS

- Never leave frying food unattended since grease can overheat and catch fire. The risk of fire is even greater in the case of used oil.
- Do not flambé under the rangehood.
- Never use the rangehood without the filters in place.
- During an electrostatic discharge (ESD) it is possible that the device will stop working. By switching the device off and on the device will again work as intended.
- CAUTION: accessible parts may become hot when used with cooking appliances.
- Remove all packaging, including protective wrappings, before use.

COMPONENTS REQUIRED

PARTS

- Keep all packing materials until the unit has been inspected.
- Inspect the product to ensure there is no shipping damage. If any damage is detected contact the dealer or retailer you bought the product from to report the damage.
- Fisher & Paykel is not responsible for shipping damage.

Supplied

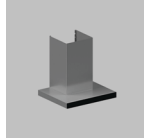

Rangehood (1)



Chimney (1)



Upper chimney (1)



Upper chimney bracket (1)



Chimney bracket (1)



Mounting duct adaptor screw (4)

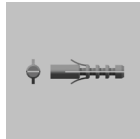

Expansion plug (8)

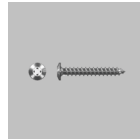

30mm phillips screw (8)



10mm self tapping screw (2)

Not supplied

Recirculation Installation only



793599 Carbon filter (2)

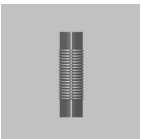

Ducting 150mm (1)*

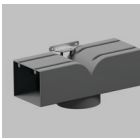

793713 Recirculation diverter kit (1)

*Additional lengths can be ordered from www.fisherpaykel.com.

PARTS

Not supplied



850mm chimney extension
792492: HC60 & HC90 models
793716: HC90DCBB4 models
793834: HC120 models

Duct out installation only

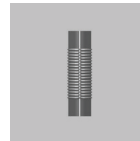

Ø150mm rigid or semi-rigid ducting (1)*



Duct outlet (Soffit, wall, roof) (1)

TOOLS

Not supplied

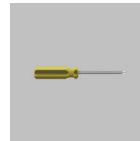

Phillips screwdriver (1)



Duct tape (1)

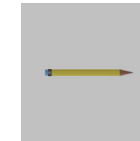

Pencil (1)



Ruler (1)



Electric drill (1)



Jigsaw (1)



Tape measure (1)

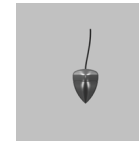

String & weight (1)



Level (1)

*length dependant on installation

PRODUCT DIMENSIONS

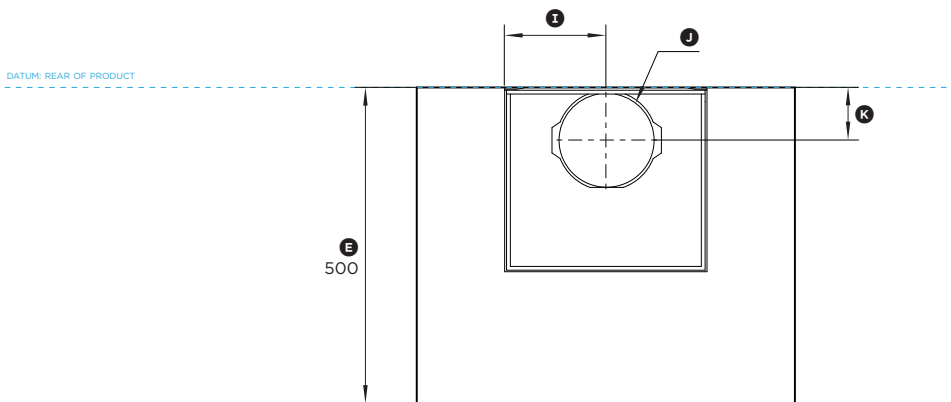

TOP VIEW

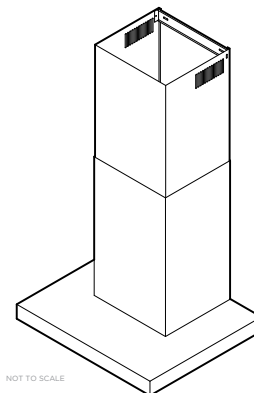

NOT TO SCALE

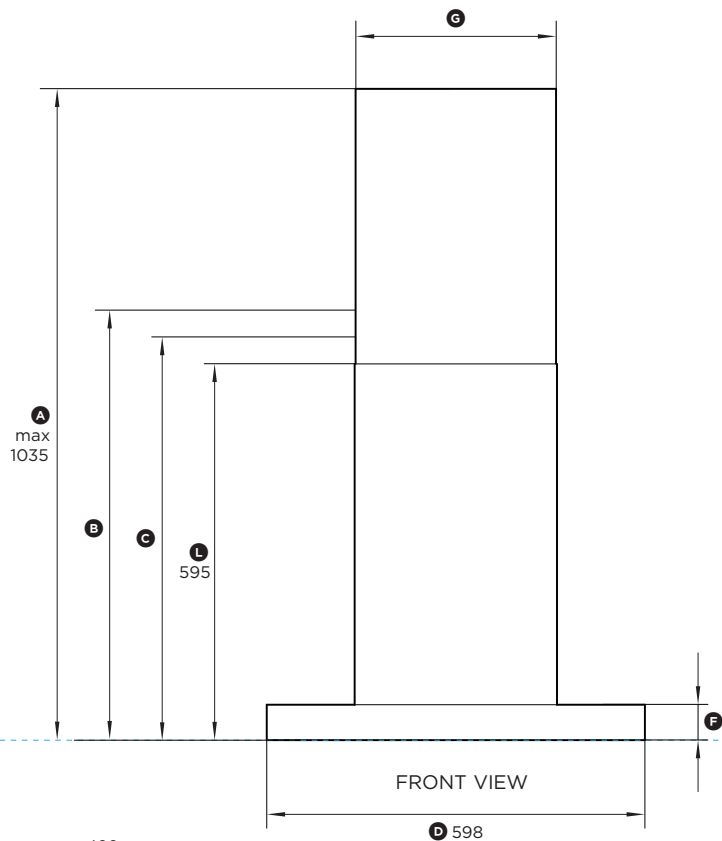

FRONT VIEW

DATUM: REAR OF PRODUCT

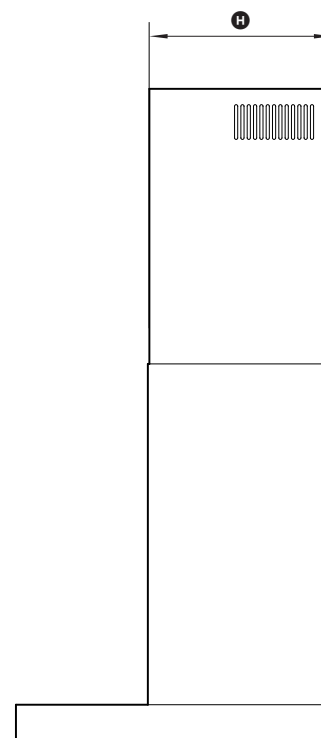

PROFILE VIEW

Model nos:
HC60DCXB4

Product Dimensions	mm
Ⓐ Maximum height of rangehood*	1035
Ⓑ Minimum overall height - recirculating	675
Ⓒ Minimum overall height	635
Ⓓ Overall width of rangehood	598
Ⓔ Overall depth of rangehood	500
Ⓣ Height of canopy	55
Ⓤ Width of chimney	320
Ⓦ Depth of chimney	290
Ⓧ Distance from centre of ducting outlet to side of chimney	160
Ⓨ Ducting outlet diameter	150
Ⓩ Distance from centre of ducting outlet to back of product	85
Ⓛ Height of datum to top of lower chimney section	595

* Maximum height with chimney extension accessories 1400mm.

Minimum distance above cooktops	mm
Height from base of product to cooking surface	min 600

Note: Minimum installation height may be greater if required by your cooktop. Refer to cooktop installation instructions.



INDICATES PRODUCT DATUM
INDICATES CABINETRY CLEARANCES - - - - -

IMPORTANT NOTE: Throughout this guide, dimensions may vary by ±2mm.

PRODUCT DIMENSIONS

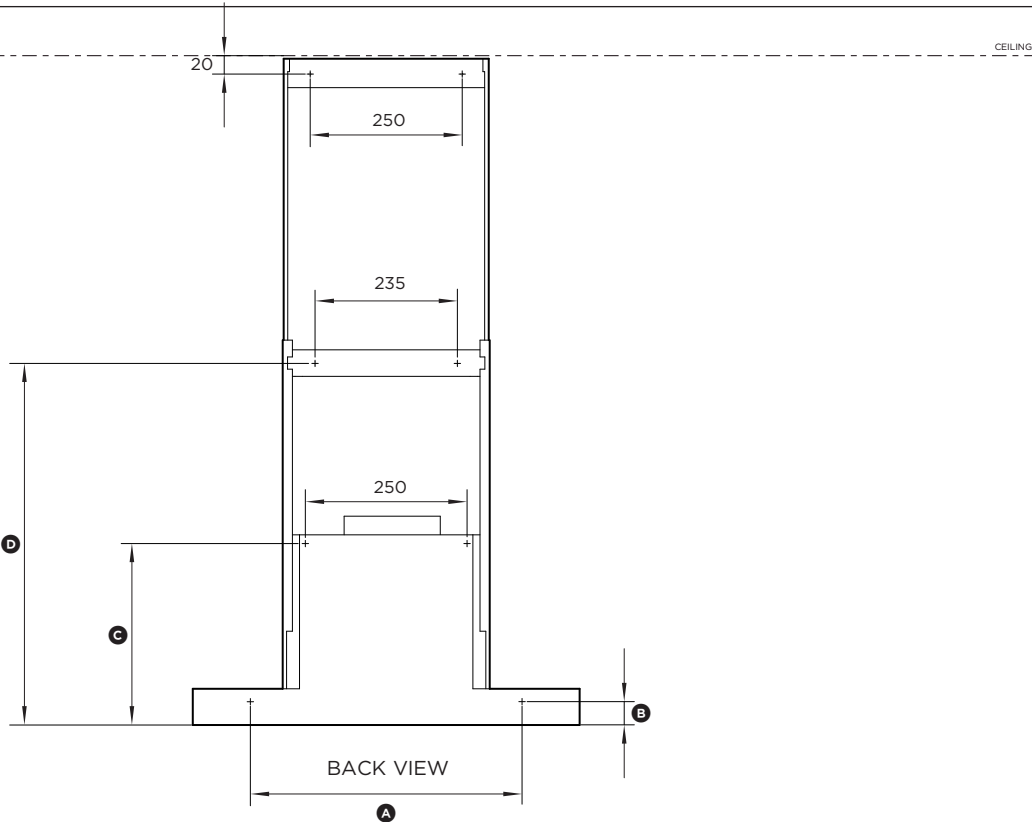

Model nos:
HC60DCXB4

Product Dimensions	mm
Ⓐ Lower rangehood attachment point width	420
Ⓑ Lower rangehood attachment point height	36
Ⓒ Upper rangehood attachment point height	286
Ⓓ Chimney bracket attachment point height	559
Ⓔ Light length	425
Ⓕ Distance from centre of light to front of product	60

DATUM: REAR OF PRODUCT

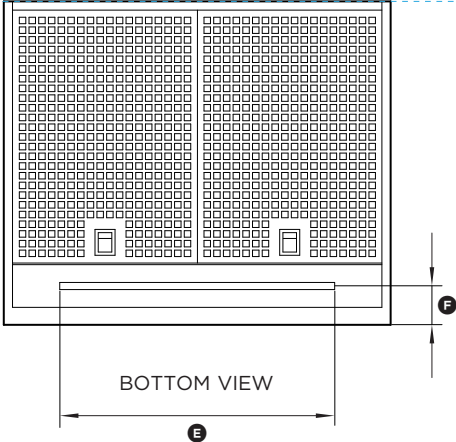

INDICATES PRODUCT DATUM
INDICATES CABINETRY CLEARANCES - - - - -

IMPORTANT NOTE: Throughout this guide, dimensions may vary by ±2mm.

PRODUCT DIMENSIONS

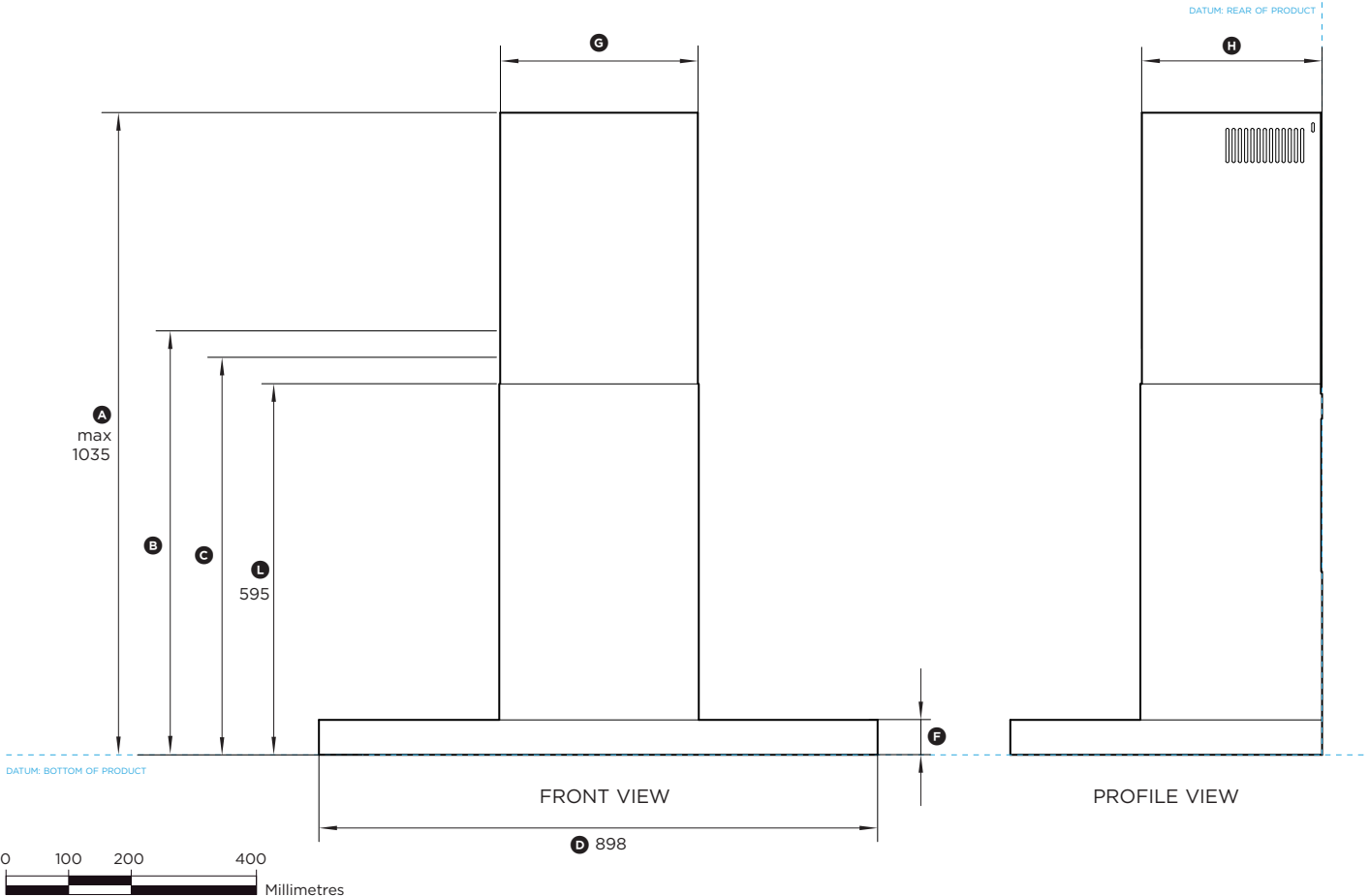
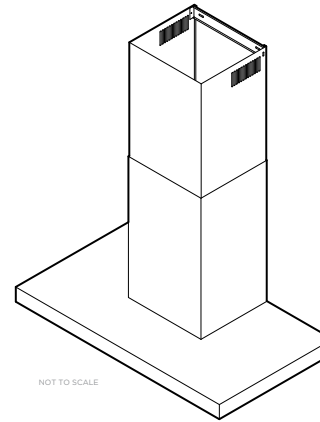
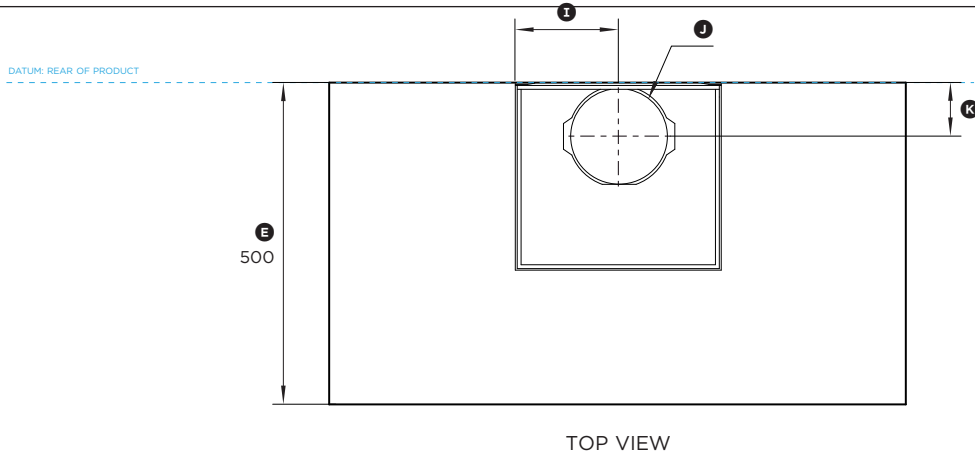

Model nos:

HC90DCXB4, HC90DCBB4

Product Dimensions	mm
Ⓐ Maximum height of rangehood*	1035
Ⓑ Minimum overall height - recirculating	675
Ⓒ Minimum overall height	635
Ⓓ Overall width of rangehood	898
Ⓔ Overall depth of rangehood	500
Ⓣ Height of canopy	55
Ⓤ Width of chimney	320
ⓕ Depth of chimney	290
Ⓡ Distance from centre of ducting outlet to side of chimney	160
Ⓢ Ducting outlet diameter	150
Ⓣ Distance from centre of ducting outlet to back of product	85
Ⓛ Height of datum to top of lower chimney section	595

* Maximum height with chimney extension accessories 55 1/8".

Minimum distance above cooktops	mm
Height from base of product to cooking surface	min 600

Note: Minimum installation height may be greater if required by your cooktop. Refer to cooktop installation instructions.

INDICATES PRODUCT DATUM -----
 INDICATES CABINETRY CLEARANCES - - - - -

IMPORTANT NOTE: Throughout this guide, dimensions may vary by ±2mm.

PRODUCT DIMENSIONS

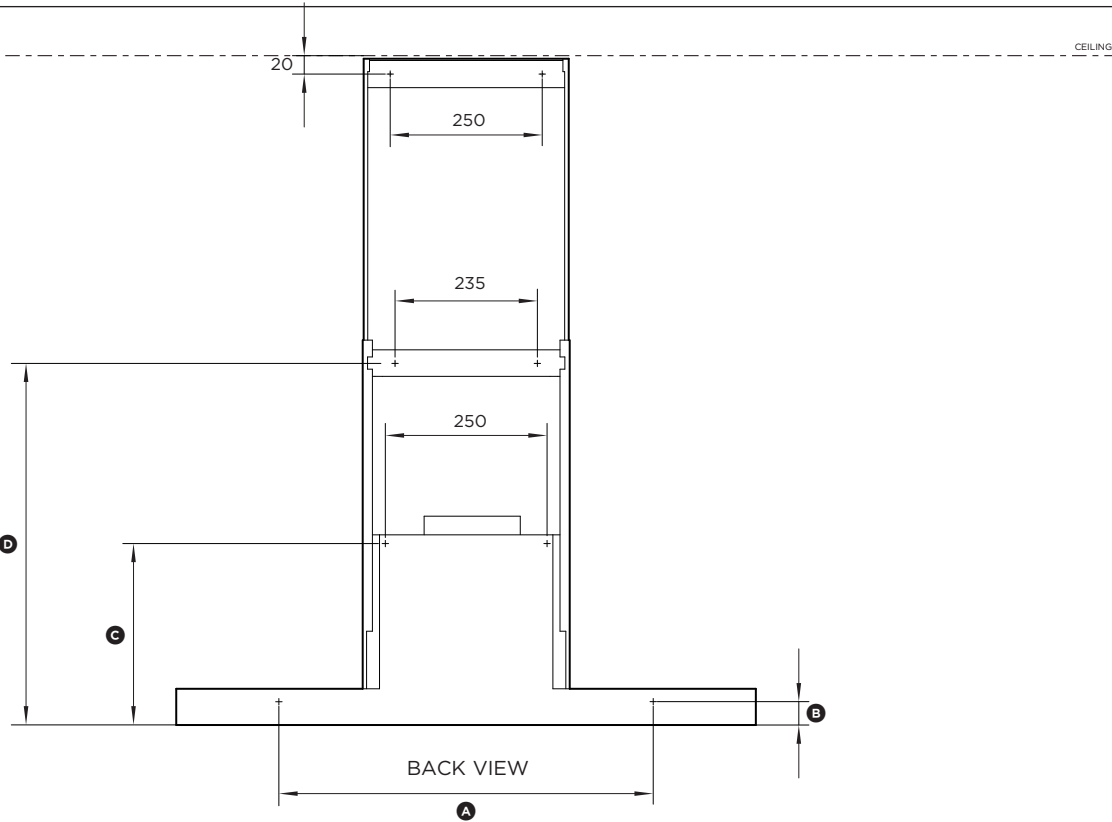

Model nos:
HC90DCXB4, HC90DCBB4

Product Dimensions	mm
Ⓐ Lower rangehood attachment point width	580
Ⓑ Lower rangehood attachment point height	36
Ⓒ Upper rangehood attachment point height	286
Ⓓ Chimney bracket attachment point height	559
Ⓔ Light length	725
Ⓕ Distance from centre of light to front of product	55

DATUM: REAR OF PRODUCT

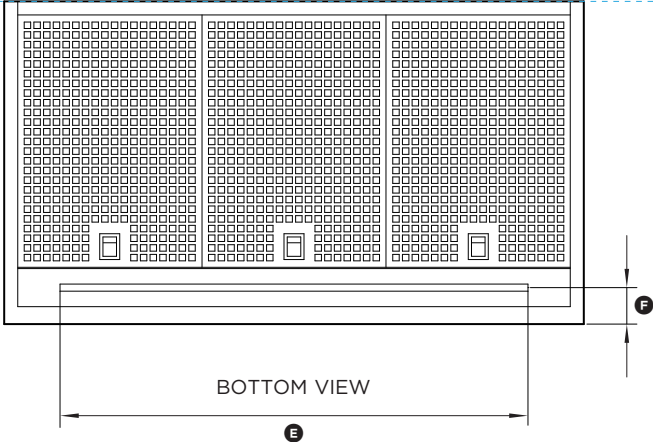

INDICATES PRODUCT DATUM
INDICATES CABINETY CLEARANCES - - - - -

IMPORTANT NOTE: Throughout this guide, dimensions may vary by ±2mm.

PRODUCT DIMENSIONS

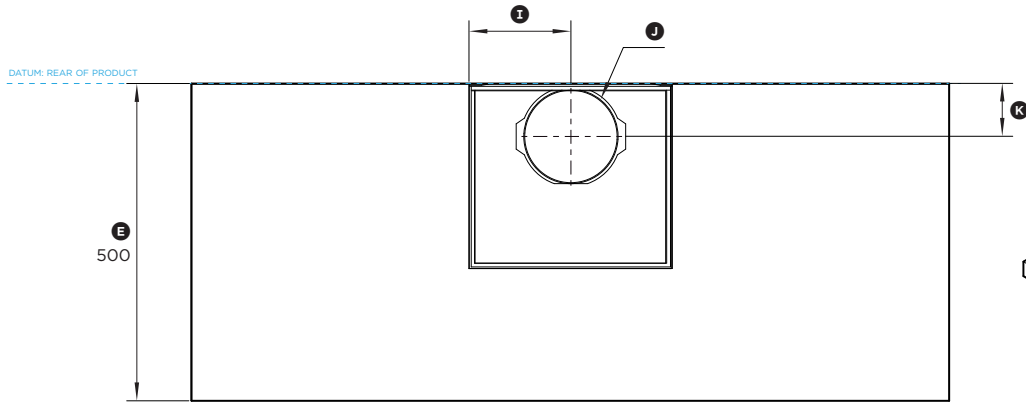

TOP VIEW

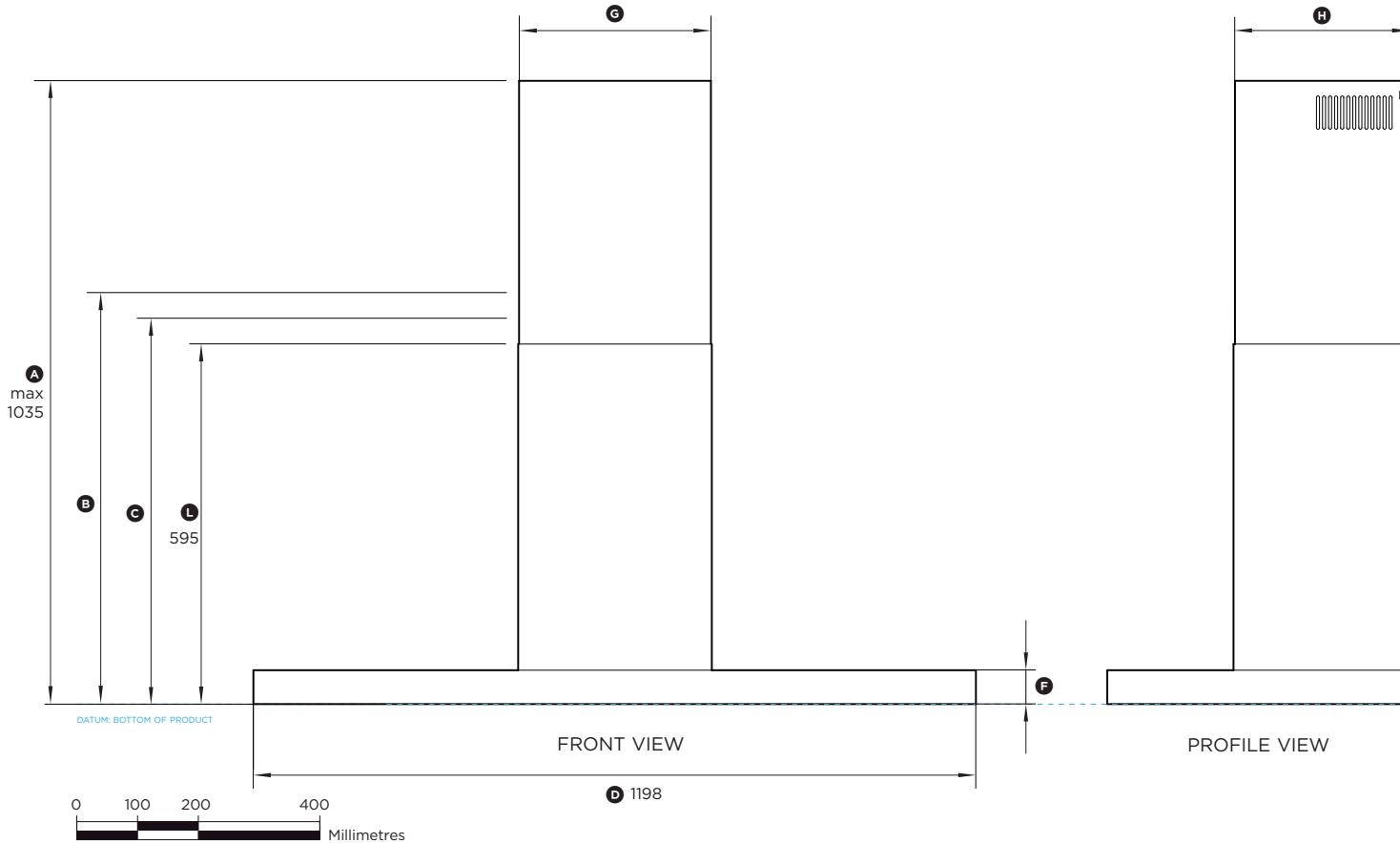
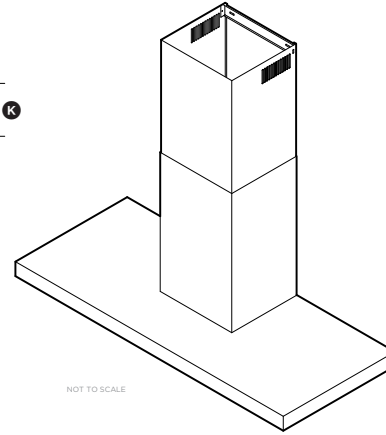

FRONT VIEW

PROFILE VIEW

Model nos:
HC120DCXB4

Product Dimensions	mm
Ⓐ Maximum height of rangehood*	1035
Ⓑ Minimum overall height - recirculating	675
Ⓒ Minimum overall height	635
Ⓓ Overall width of rangehood	1198
Ⓔ Overall depth of rangehood	500
Ⓕ Height of canopy	55
Ⓖ Width of chimney	320
Ⓗ Depth of chimney	290
Ⓛ Distance from centre of ducting outlet to side of chimney	160
Ⓜ Ducting outlet diameter	150
Ⓧ Distance from centre of ducting outlet to back of product	85
Ⓝ Height of datum to top of lower chimney section	595

* Maximum height with chimney extension accessories 1400mm.

Minimum distance above cooktops	mm
Height from base of product to cooking surface	min 600

Note: Minimum installation height may be greater if required by your cooktop. Refer to cooktop installation instructions.

INDICATES PRODUCT DATUM - - - - -
INDICATES CABINETRY CLEARANCES - - - - -

IMPORTANT NOTE: Throughout this guide, dimensions may vary by ±2mm.

PRODUCT DIMENSIONS

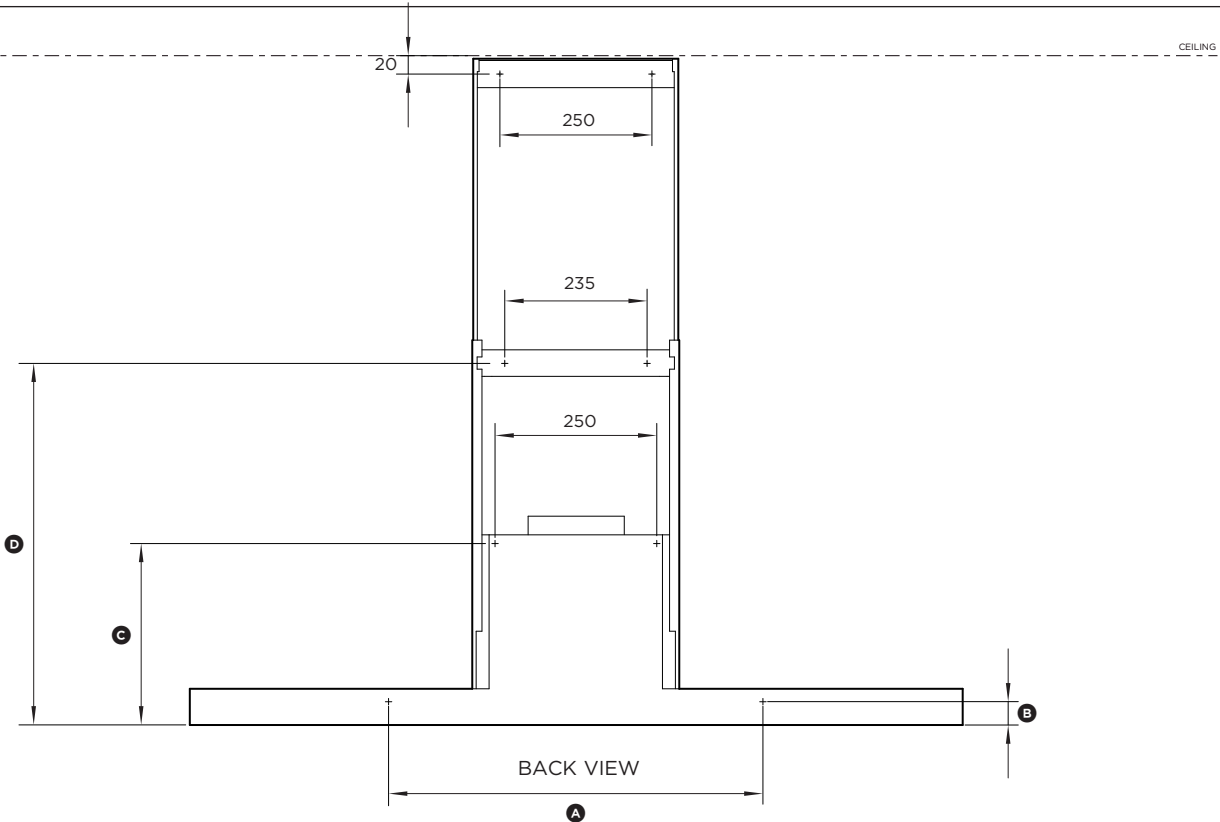

Model nos:
HC120DCXB4

Product Dimensions	mm
Ⓐ Lower rangehood attachment point width	770
Ⓑ Lower rangehood attachment point height	36
Ⓒ Upper rangehood attachment point height	286
Ⓓ Chimney bracket attachment point height	564
Ⓔ Light length	725
Ⓕ Distance from centre of light to front of product	60

DATUM: REAR OF PRODUCT

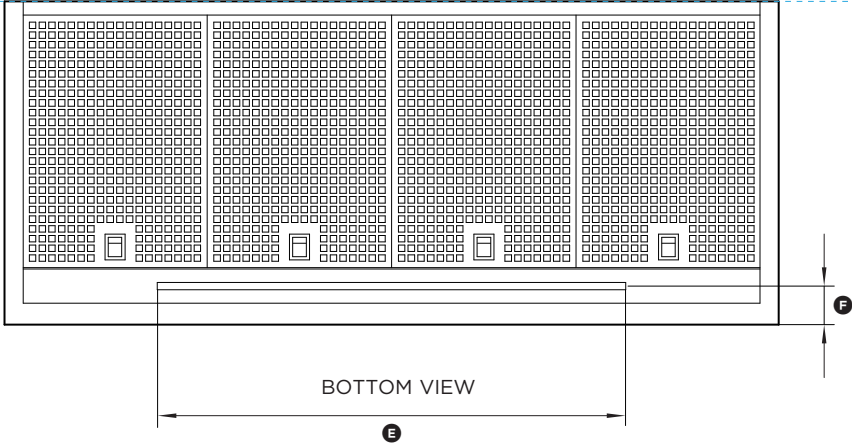

INDICATES PRODUCT DATUM -----
INDICATES CABINETY CLEARANCES -----

IMPORTANT NOTE: Throughout this guide, dimensions may vary by ±2mm.

INSTALLATION HEIGHT

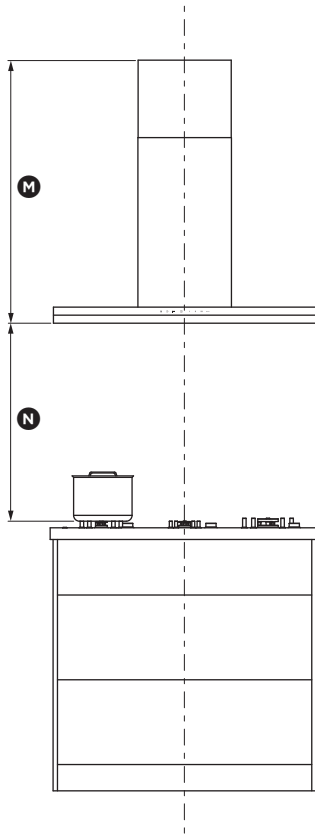

INSTALLATION DIMENSIONS

	mm
Ⓜ Installation height	
Ducted externally	min. 635 – max. 1035
Recirculation mode	min. 675 – max. 1035
With chimney extension	max. 1400
Ⓝ Height top of cooktop to base of product	min. 600

These rangehoods must be installed no lower than the minimum height indicated in the table above. Minimum installation height may be greater if required by the cooktop, refer to your cooktop installation guide.

Induction cooktop considerations

- Induction cooktops use energy efficient technology that only heats the contents of a cooking pot.
- Unlike gas or traditional electric cooktops, the surrounding air does not get heated when using an induction cooktop. As a result, rangehood filters, splashbacks and surrounding cabinetry do not get warmed up, increasing the likelihood of condensation on these cooler surfaces.
- Other factors like ambient temperature, humidity, natural ventilation of the room, size of the cookware and how the induction cooktop is being used also influence condensation. For example, aggressive boiling on high cooktop heat settings like PowerBoost increases the rate at which water is evaporated, increasing the likelihood of condensation.
- It is important to understand that neither the rangehood nor the induction cooktop are faulty as a result of this phenomenon.

Condensation can be minimised by:

- Installing the rangehood at the maximum height above the cooktop as specified in this user guide.
- Using the rangehood on a lower speed setting when boiling.
- Using the induction cooktop on a lower heat setting when boiling.
- Switching the rangehood on 5 minutes before cooking and letting it run for at least 5 minutes after cooking. Refer to the 'Operating instructions' section on how to use the timer function.
- NOTE: recirculation does not remove moisture.

VENTING REQUIREMENTS

Venting options

Attention should be given to ensure that any applicable regulations concerning the discharge of exhaust air are fulfilled.

The rangehood can be installed to operate with the exhaust air ducted externally from the kitchen, or installed to operate in recirculation mode with the exhaust air recirculating within the kitchen.

Ducted externally

For an externally ducted installation it is recommended that 150 mm diameter, rigid or semi-rigid ducting is used. This will require a 160 mm (min) round hole in the ceiling or wall. Care should be taken to position the hole correctly.

For optimal efficiency use the shortest and straightest duct route possible and use rigid or semi-rigid ducting for reduced noise and increased airflow. Flexible metal ducting should only be used as a last resort (ie in difficult installations) and if used ensure that it is straight and smooth and extended as much as possible.

Recirculation mode

To enable the product to operate with the air recirculating within the kitchen, please purchase a recirculation diverter and carbon filters (refer to the 'Parts and accessories' section). The recirculation diverter is installed after a short length of ducting and is required to channel the air out the side vents at the top of the chimney and the carbon filters are required to remove odours.

Note: a ducting hole is not required in the wall or ceiling if the rangehood is installed to operate in recirculation mode.

Vent installation types:

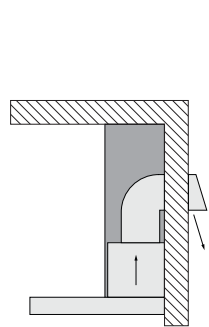

Vent through exterior wall

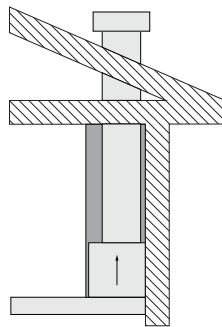

Vent through roof

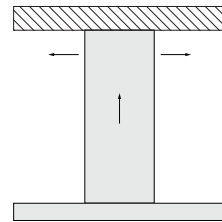

Recirculate with carbon filters

ELECTRICIAL REQUIREMENTS

Before connecting the rangehood to the power supply, ensure the voltage and frequency indicated on the rating plate match that of the installation location:

MODEL	FREQUENCY	VOLTAGE	TOTAL POWER
HC60DCXB4	50 Hz	220 - 240 V	248 W
HC90DCXB4			
HC90DCBB4			
HC120DCXB4			

INSTALL PREPARATION / CONSIDERATIONS

1

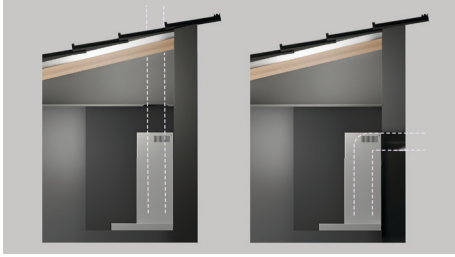

Ducting options:

Duct to roof and out external wall or soffit.

Duct to external wall and out.

2



Ensure the space is set up to the correct specifications. Refer to 'Installation height' for details.

Determine if a chimney extension is required. Refer to 'components required' for part extension part numbers.

3



Refer to cooktop specifications to ensure adequate clearances are maintained.

4



Check wall is flat and constructed of appropriate materials that can support the rangehood.

5



Check for wall studs.*

6



One power outlet is required behind chimney.

*When no wall studs align with the desired installation location, cut a hole and secure wood behind plaster board to allow rangehood to be secured and mounted.

CHECK MATERIALS AND PARTS

①



Ensure the ducting is the correct length and compatible to the rangehood.

UNPACK PRODUCT

①



Open carton and remove all packaging. Carefully lift the products out of the cartons.
Place on a protected surface.

②



Dispose of packaging responsibly.
Recycle where possible.

③

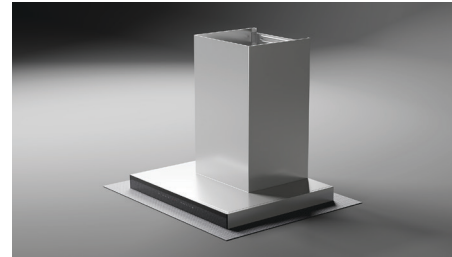

Inspect product for any damage.
Connect to power and test.

PREPARE INSTALL LOCATION

Centre rangehood over cooktop and ensure all required clearances are maintained.
Check wall for studs. Using the guide shown, mark the upper and lower attachment points on the wall.

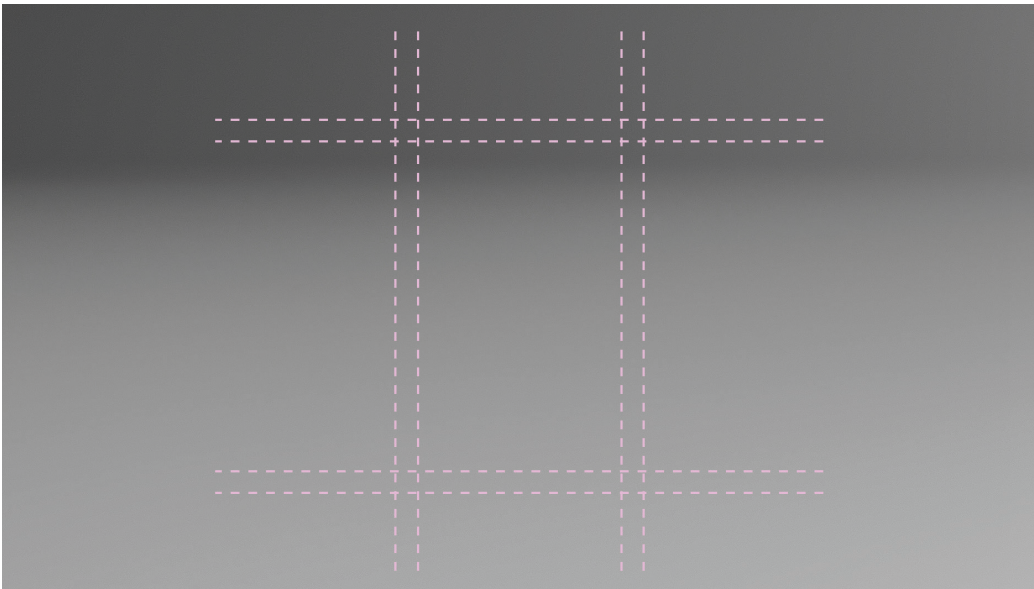

①



Drill attachment holes.
Wood: 3mm diameter hole.
Drywall or no wall stud: 5mm hole.

②



If a cornice is present:
Remove a section equal to the width of the chimney. Refer to the product dimension page.

③

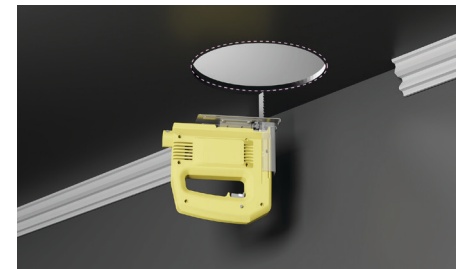

Not required for recirculation installations
Measure and mark the centre of the 150mm duct hole. Cut using a jigsaw.

INSTALL BRACKETS

①

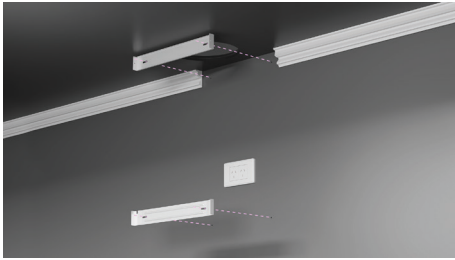

Centre and secure the upper and centre chimney brackets using two 30mm self tapping screws per bracket.

If a cornice is present:

Move the upper chimney brackets lower to avoid cornice clashing with chimney screws.

②

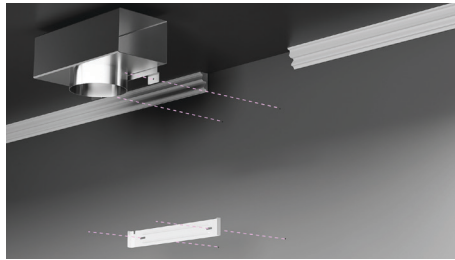

Recirculation installation only:

Align recirculation adapter to the upper bracket. Fit using 30mm Phillips screws.

INSTALL DUCTING

RIGID DUCTING

①

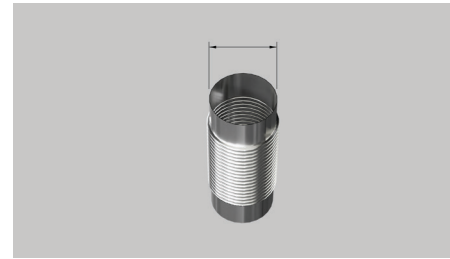

Ensure the ducting is the correct length and compatible to the rangehood.
Do not reduce the duct diameter as this will increase noise and reduce performance.

②

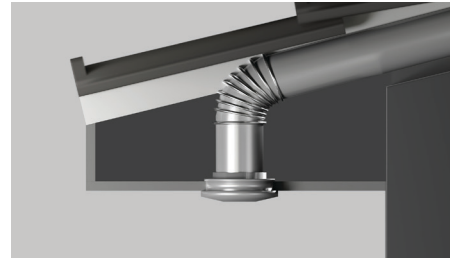

Install external venting as required:
Weather proofing requirements depend on the cladding/roofing type.
Soffit external venting.



Install external venting as required:
Wall external venting.



Install external venting as required:
Roof external venting.

INSTALL DUCTING

RIGID DUCTING

3

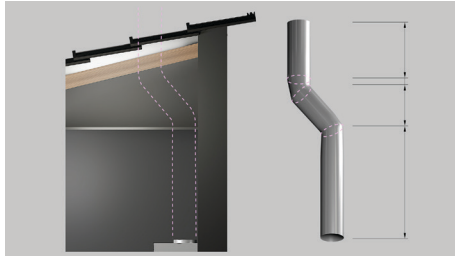

Cut ducting to length.

4



Route ducting and assemble.

5



Tape ducting to seal.

6

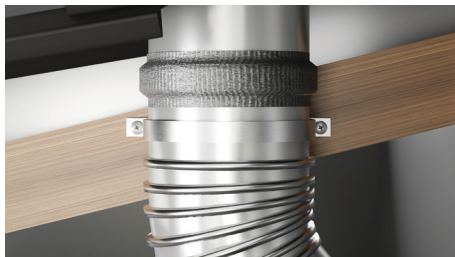

If required, secure ducting within ceiling.

7

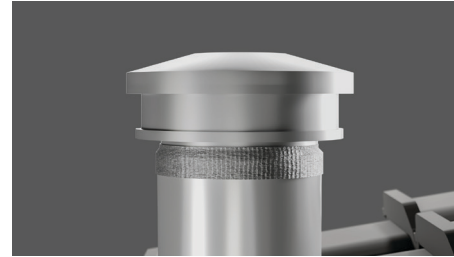

Fit ducting to the external vent and secure.

INSTALL DUCTING

SEMI-RIGID DUCTING

1

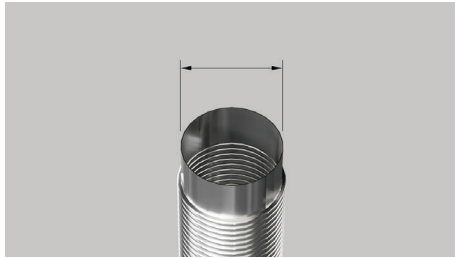

Ensure the ducting is the correct length and compatible to the rangehood.

2

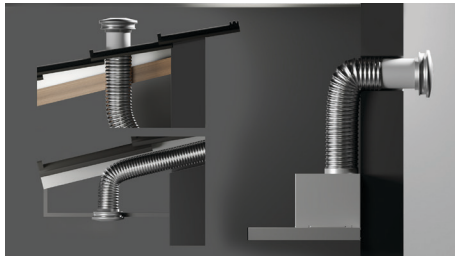

Install external venting as required. Weather proofing requirements depend on the cladding/roofing type. Options for external venting include soffit, wall or roof.

3

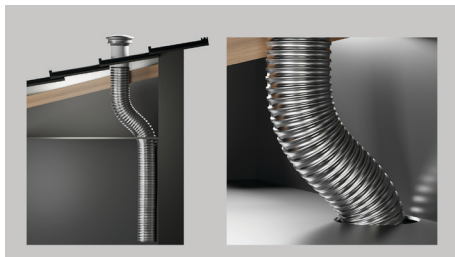

Route ducting and assemble.

4

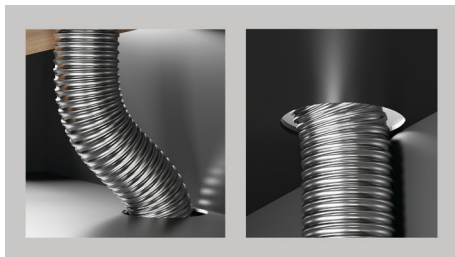

Ensure ducting is not loose, kinked or crushed.

5



Tape ducting to seal.

6



If required, secure ducting within ceiling to reduce noise.

7

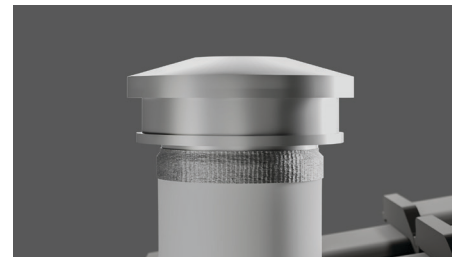

Fit ducting to the external vent and secure.

PREPARE HOOD

①

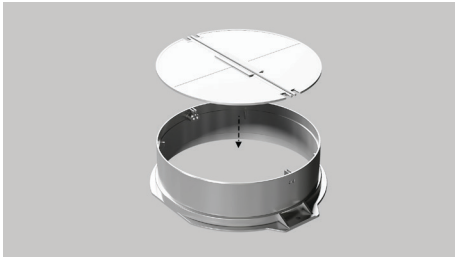

Slot non-return valves into the adapter and ensure they move freely when installed.

②

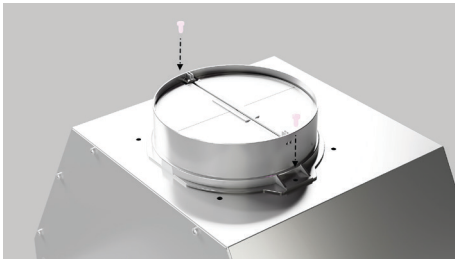

Fit the duct adapter to the rangehood using two supplied Phillips screws.

③



Unclip filters to remove.

INSTALL HOOD

①

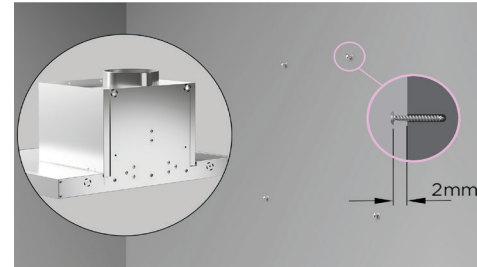

Install the 30mm upper hood mounting screws* as per the product dimension page. Ensure both screws protrude 2mm.

②

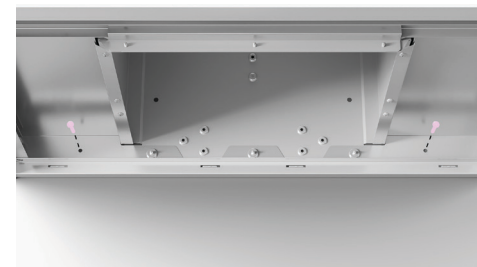

Lift the rangehood and slot onto the two upper hood mounting screws. Drill and secure the two supplied* lower attachment screws through the holes underneath the rangehood.

③

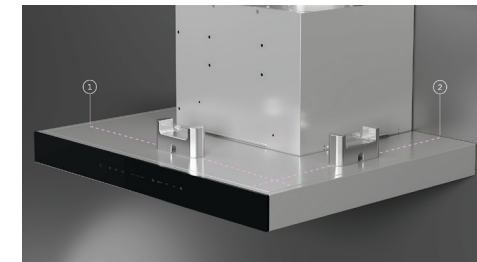

Level the front and side of the rangehood and adjust the two supplied lower attachment screws.

④

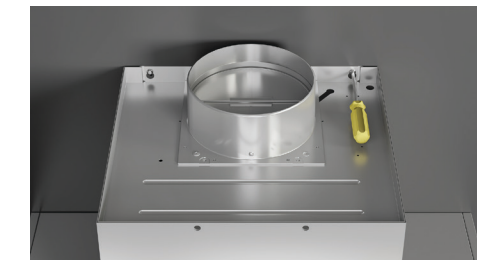

Tighten the two upper attachment screws. If the wall is uneven, loosen lower screws and install packers to level the rangehood to wall.

*Use plastic wall plugs as required.

SECURE DUCTING

①

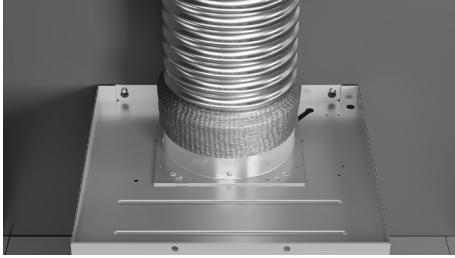

Attach ducting to the adapter.
Secure using tape, cable ties or metal straps as required.
Ensure backdraft damper flaps are not obstructed by the ducting.

②



Plug in and turn power on.

INSTALL CHIMNEY

Remove the protective film from all chimney surfaces.

①

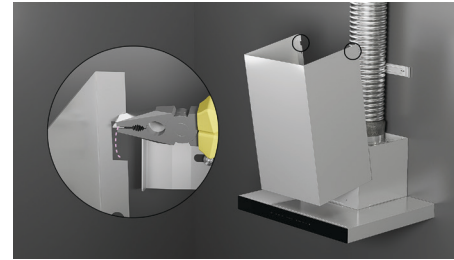

Bend lower chimney tabs inwards using pliers.

②



Align the chimney to the lower chimney bracket and slot into place.

③



Extend the upper chimney and secure to the upper chimney bracket using two 10mm Phillips screws.

④

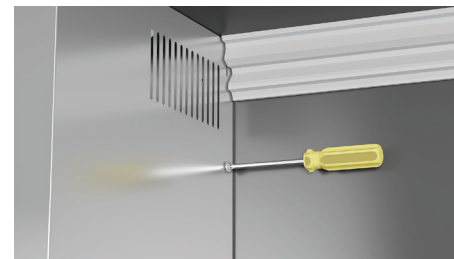

If an adjacent cornice is present:

Two new holes in the chimney may be required to secure the rangehood to the wall if a cornice is present.

INSTALL CHIMNEY

5



Ensure filters are orientated correctly before clipping back into place. Remove all protective film from surfaces.

6

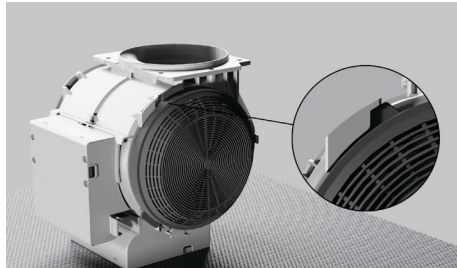

Recirculation only:
Install the carbon filters onto the blower. Rotate the filter until secure.

INSTALLER CHECKLIST

TO BE COMPLETED BY THE INSTALLER

- Have all packaging been removed?
- Rangehood is correctly installed
- All connections are secure
- The ducting is not bent or crushed in any areas
- Check rangehood suction
- External vent is sealed appropriately
- All local regulations have been met
- Operation has been tested (refer to rangehood user guide)
- Check for unusual noises

Complete and keep for safe reference:

Model _____

Serial no. _____

Purchase date _____

Purchaser _____

Dealer address _____

Installer's name _____

Installer's signature _____

Installation company _____

Installation date _____

FISHERPAYKEL.COM

© Fisher & Paykel Appliances 2023. All rights reserved.

The models shown in this guide may not be available in all markets
and are subject to change at any time.

The product specifications in this guide apply to the specific products and
models described at the date of issue. Under our policy of continuous product
improvement, these specifications may change at any time.

For current details about model and specification availability in your country,
please go to our website or contact your local Fisher & Paykel dealer.

431165A 09.23