

DISHDRAWER™ DISHWASHER

NZ AU US CA GB IE

Keep this document handy for easy reference.

- For detailed information on the features of your dishwasher, see your 'User guide'.
- Before using your dishwasher, make sure you read the full 'User guide', with special attention to the 'Safety and warnings' section.
- For contact information or if you require service, assistance or replacement parts, see the end of this document or your 'Service & warranty' booklet.

YOUR MODEL

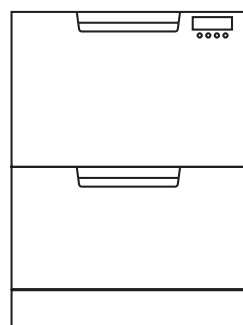

Double models
 DD60DAW9
 DD60DAX9
 DD60DAHW9
 DD60DAHB9
 DD60DAHX9
 DD24DAW9
 DD24DAB9
 DD24DAX9

Note: each drawer can run independently of the other drawer.

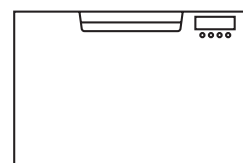

Single models
 DD60SAX9
 DD60SAHX9
 DD24SAW9
 DD24SAB9
 DD24SAX9

OPERATING INSTRUCTIONS – STARTING A WASH



Discard scraps
 Scrape large food particles off (e.g. bones, fruit stones) and remove any foreign objects (e.g. toothpicks, strings, paper).

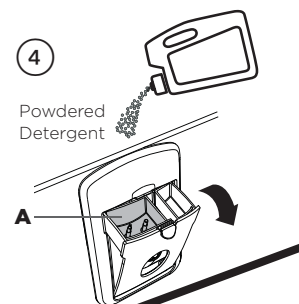

Add detergent
 Fill the detergent dispenser (A) with powdered detergent and close the dispenser door.

IMPORTANT!
 Do not place liquid detergent or tablets in the detergent dispenser.

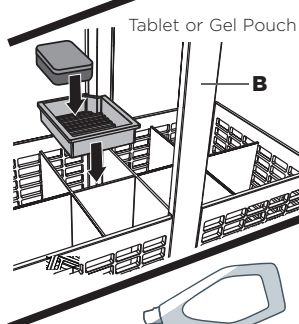

If using a tablet or gel pouch, place it in the cutlery basket (B) or at the edge of the base rack (see user guide for details)

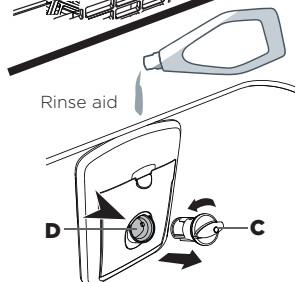

Check rinse aid
 If the indicator on its plug (C) glows bright red, refill the rinse aid dispenser (D) with liquid rinse aid. Make sure you then refit the rinse aid plug back into its original position, by rotating the plug back into an upright position.

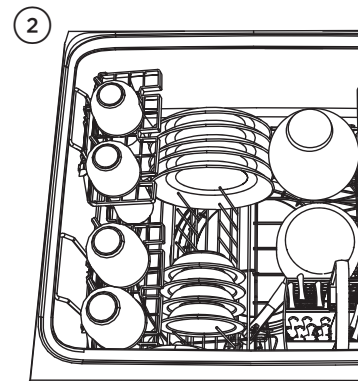

Load dishes carefully
 To help with wash performance, arrange dishes so they are evenly spaced and not nesting.

IMPORTANT!
 Accommodates plates up to a max height of 280mm (11") for standard tubs or 310mm (12 1/4") for tall tubs.

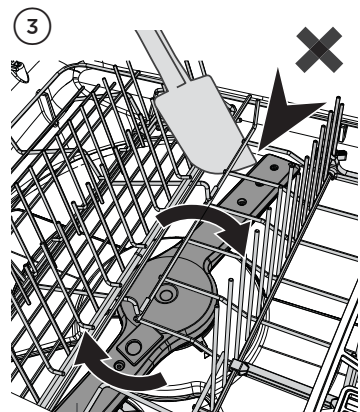

Check spray arm(s) are mounted correctly and can rotate fully around

Check the spray arm is mounted correctly by physically rotating it around with your hand.

Before a wash, ensure there are no items blocking the spray arm(s) from rotating.

Rotating Spray arm



Select wash
 Power the dishwasher on ① then select wash program >>.

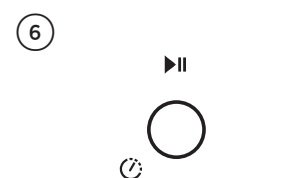

Start wash or set Delay start
 Ensure drawer is closed.
 To start wash: Press ►►.
 To set delay start: Press and hold ►► to enter delay start, then press and hold ►► again to increase the delay start time.

Single models

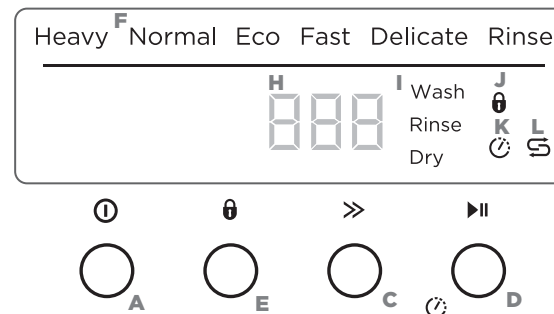

Double models

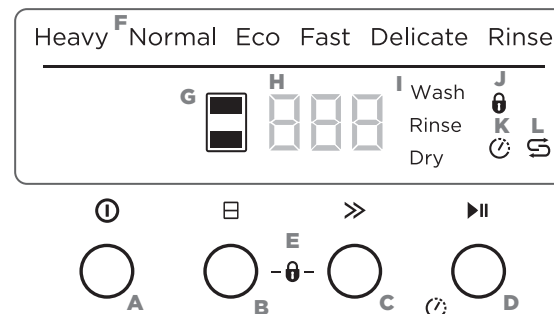

Controls Description

- A Off/On**
 Press ① to turn the dishdrawer on or off.
 • Opening the drawer will automatically turn the dishwasher on.
- B Drawer selector (Double models only)**
 Press ◻ to scroll between drawers.
- C Wash program selector**
 Press >> to scroll through wash program options.
- D Start / Delay Start**
 Press ►► to start the wash.
 To pause: Press ►► again. The wash stage indicator Wash and ◻ (Double models) will flash.
 • Wait for the 3 short and one long tone before opening the drawer. Forcing it open mid cycle may cause damage or injury.
 • If the drawer is not restarted within 7 minutes it will tone intermittently until it is restarted.

Double models interface shown

Wash program indicators
 These show which program is selected.

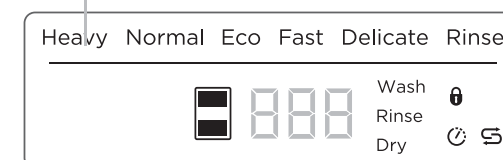

- D To Delay start**
 ① Press and hold ►► until Hh appears on the display, then release. You are now in Delay start mode.
 ② Press ►► until the display shows the number of hours you want to delay the start of a wash by (1 to 12 hours).
 • Note: If you scroll past 12 hours the dishwasher will exit Delay start mode. To re-enter delay start follow step 1 above.
 • The wash will start once the delay time is over, provided the drawer is closed.

- DD24 models only**
 If the drawer is opened after delay start has been set (for example if you need to load more dishes), delay start will be paused after the drawer is closed.
To restart delay start:
 Close the drawer.
 • Single models: ⏸ will flash.
 • Double models: ◻ and ⏸ will flash.
 • Press ►► to resume.

Cancel wash/Cancel Delay start
 Press ① to cancel a wash that has already started or to cancel the Delay start setting.

- If there is any water in the drawer, it will automatically drain before the dishwasher turns off.

- E Keylock**
 Keylock disables all the buttons - helpful when cleaning the dishwasher.

Single models
 To activate: press and hold ◻ until you hear one tone. The keylock indicator ◻ will come on.
 To cancel: press and hold ◻ until you hear another tone and the keylock indicator stops flashing and goes out.

Double models
 To activate: press and hold ◻ and >> together until you hear one tone. The keylock indicator ◻ will come on.
 To cancel: press and hold ◻ and >> together until you hear another tone and the keylock indicator stops flashing and goes out.

- E Childlock**
 Childlock disables all the buttons and locks the drawer closed, preventing unauthorized use by children.

Single models
 To activate: press and hold ◻ until you hear a second tone. The keylock indicator ◻ will come on.
 To cancel: press and hold ◻ until you hear another tone and the keylock indicator stops flashing and goes out.

Double models
 To activate: press and hold ◻ and >> together until you hear a second tone. The keylock indicator ◻ will come on.
 To cancel: press and hold ◻ and >> together until you hear another tone and the keylock indicator stops flashing and goes out.

- F Wash program indicators**
 These show which program is selected.

G Drawer indicator (Double models only)
 White: drawer is running and selected.
 Dim: drawer is running but not selected.
 Flashing: drawer is paused

H Display
 • Time remaining (minutes)
 • Fault code numbers (see 'If there is a fault' in User guide).

I Wash stage indicators
 (See 'During and after the wash cycle').

J Keylock/Childlock indicator
 If lit: keylock or childlock is activated.

K Delayed start indicator
 If lit: delayed start is set.

L Salt indicator
 (Water softener models only)
 If lit: salt reservoir is empty.

WASH PROGRAMS

PROGRAM	DESCRIPTION
Heavy	Heavily soiled pots, pans and dishes.
Normal (default setting)	Dishes that are quite heavily soiled or food soils that have been left to dry overnight.
Normal Eco	Normally soiled dishes for optimum water and energy usage. The US/Canada Energy Guide is based on this cycle.
Fast	Lightly soiled dishes.
Delicate	Lightly soiled and heat sensitive crockery.
Rinse	Prevents odours and soils from drying on dishes.

DURING AND AFTER THE WASH

As the wash progresses, the display will count down the minutes remaining and show what stage the program is at. When the program has finished, the display will show  and the dishwasher will sound a tone. After 30 seconds the display will go out.

Wash
Rinse
Dry

You may notice the following noises at the end of the wash. These are all part of normal operation:

- Both drawers may be draining simultaneously.
- The drying fan may continue to run after a wash program has finished for a set time or until the drawer is opened. The fan assists with drying and uses negligible amounts of energy.

For best drying results, we recommend unloading the dishes once they have cooled.

DOS AND DON'TS OF LOADING

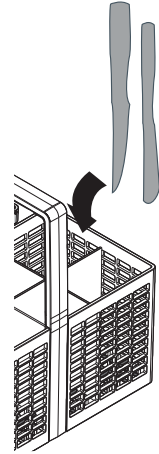

Sharp or pointed items must be placed horizontally or with sharp edges/points facing down to avoid risk of injury.

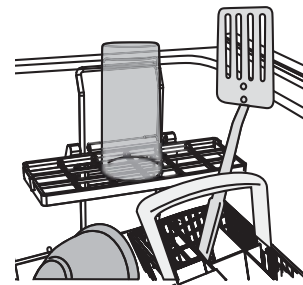

Protruding items will stop the internal lid of the dishwasher from sealing properly, which could result in a service call.

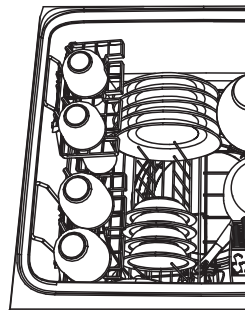

A neatly arranged load with evenly spaced dishes helps wash performance.

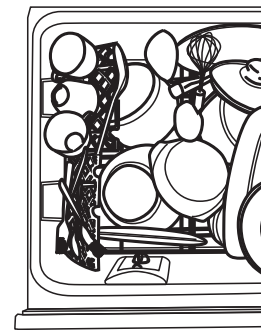

Overcrowding reduces wash performance.

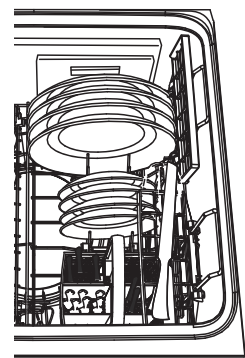

Ensure there is enough space between plates. Mix spoons, knives and forks within the cutlery basket to prevent them from nesting.

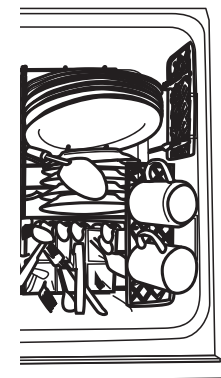

If plates and cutlery are nesting, they are less likely to be cleaned well.

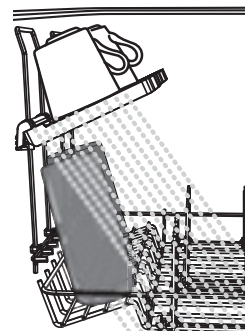

Ensure that water reaches all items on the racks.

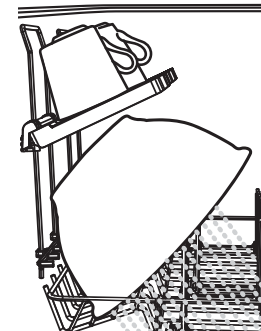



Dishware is blocking water from reaching items on the racks.

PREFERENCE OPTIONS

You can change the setting of these options to suit your preferences or circumstances. We recommend selecting the most suitable settings before you start using your dishwasher.



OPTION	RINSE AID	WATER SOFTENER (SOME MODELS ONLY)	OPEN DRAWER AUTO POWER-ON (SUITABLE AS A SABBATH OPTION)	TURN TONES OFF	CLOSED DRAWER AUTOLOCK
What does it do?	Regulates the amount of rinse aid dispensed. Reduce this setting if there is excess foam after a wash. Increase this setting if dishes are wet or streaky after a wash.	Refer to the 'Water softener' section of the 'User guide' for details.	Your dishwasher is factory-set to automatically power on for 30 seconds whenever you open the drawer. You can turn this setting off.	This turns all tones off except for fault alerts.	When this setting is on, the drawer will automatically lock 30 seconds after it's closed. It can then be unlocked by pressing  (unless Keylock or Childlock is also activated). Useful in boats or motor homes.

How to change the setting of an option

- 1 CHECK
Check that there is no wash underway, press .
- 2 ENTER MENU & SCROLL TO OPTION
To enter the menu: Press and hold the  and  together for four seconds.
 - You are now in the Rinse aid option of the preference options menu.
 - If you want to change the Rinse aid setting, go to step 3 now.
 - If you want to change the setting of another option, you will need to scroll to that option first.

To scroll to the next option: press . To know which option you're in, watch the letters in the display (see table below). When you have scrolled to the end of the sequence, the menu will start again with Rinse aid.

OPTION	RINSE AID	WATER SOFTENER (SOME MODELS ONLY)	OPEN DRAWER AUTO POWER-ON (SUITABLE AS A SABBATH OPTION)	TONES AT END OF WASH	CLOSED DRAWER AUTOLOCK
Which option am I in?	rA	Hd	AP	bP	Ld
Possible settings	Off to Max (rA5)	Off to Max (Hd5)	On or Off	On or Off	On or Off
Example	setting is 1 rA1	setting is 1 Hd1	On APo	On bPo	On Ldo
	setting is 4 rA4	setting is 4 Hd4	Off AP-	Off bP-	Off Ld-

- 3 CHANGE SETTING
Press  to change the setting within an option. For example, to change the Rinse aid setting from 4 (factory default) to 2, you need to press  3 times.
- 4 SAVE SETTING & QUIT MENU
Press . This will save the new setting and quit the preference options menu.

FOR MORE INFORMATION

For detailed information on the features of your dishwasher



see your 'User guide'

For warranty information



see your 'Service and warranty' booklet

If you...

- have any questions or comments
- need a Fisher & Paykel authorized technician to service your product
- need replacement parts or accessories
- want to register your product



see your 'Service and warranty' booklet or contact us via our website:

www.fisherpaykel.com