

Top Loader Washing Machine, 5.5kg

Series 3 | Top Load

White



A powerful, quiet washing machine with SmartDrive™ technology, perfect for a small household.

- Four wash cycles including Wool and Delicate
- With SmartDrive™ technology for a quiet and reliable wash
- Auto out of balance correction for a hassle-free wash
- Detergent and fabric softener dispenser

DIMENSIONS

Height	1030 - 1050mm
Width	560mm
Depth	560mm

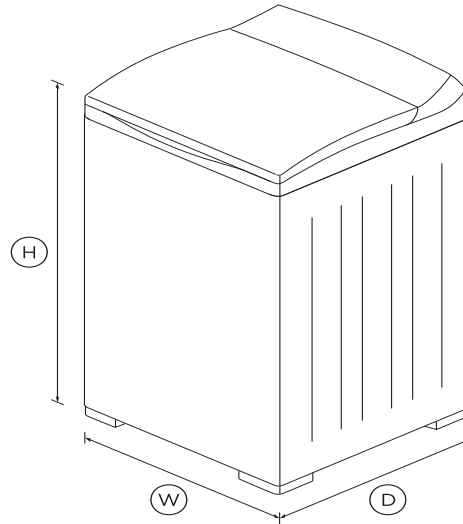

SPECIFICATIONS

Consumption

Energy rating	1.5 star
Energy usage	499kWh/year
In-use energy carbon	67.6kgCO2e/year
Water consumption per cycle	77L
Water efficiency	3 star (WELS)

Features

Agitator	Flexible finned
Auto out of balance correction	•

Detergent dispenser	•
Eco rinse	•
Fabric softener dispenser	•
Lid lock	•
Manual water levels	3
No spin / Spin Hold	•
Rinse options	3
Spin speeds	3
Stainless steel drum	•
Water temperature controls	3

Performance

Auto-Lint disposal	•
Load sensing	•
Maximum spin speed	1000rpm
Number of spin speeds	3
SmartDrive™ technology	•

Product dimensions

Depth	560mm
Height	1030 - 1050mm
Height (Lid open)	1320 - 1350mm
Width	560mm

Warranty

Parts and labour	2 years
Parts only SmartDrive™ Motor	10 years

Wash Cycles

Delicate	•
----------	---

Heavy	•
Number of wash cycles	4
Quick	•
Regular	•
Wool	•

SKU	93260
-----	-------

The product dimensions and specifications in this page apply to the specific product and model. Under our policy of continuous improvement, these dimensions and specifications may change at any time. You should therefore check with Fisher & Paykel's Customer Care Centre to ensure this page correctly describes the model currently available. ? Fisher & Paykel Appliances Ltd 2020

Other product downloads available at fisherpaykel.com

- [↓](#) User Guide
- [↓](#) Service & Warranty
- [↓](#) Energy & Water Label
- [↓](#) Installation Guide



A PEACE OF MIND SALE

24 Hours 7 Days a Week Customer Support

T 0800 372 273 W www.fisherpaykel.com