

# Insert Range Hood, 24"

Series 7 | Integrated

Stainless Steel and Glass



With edge-to-edge extraction, this range hood is perfectly hidden away in your cabinetry.

- With three fan speeds plus a boost function, select the perfect extraction rate for your cooking
- Perimeter extraction for efficient removal of steam and odors
- Powerful maximum air movement of 400CFM
- Wi-Fi enabled for notifications through the SmartHQ™ app

## DIMENSIONS

Height	12 7/16"
Width	20 7/8"
Depth	11"

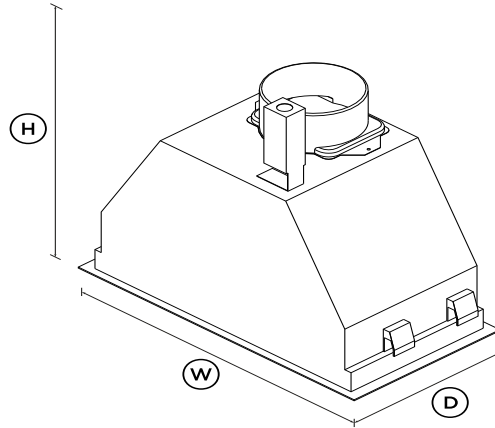

## FEATURES & BENEFITS

### Achieve The Invisible

This high quality integrated range hood seamlessly blends behind cabinetry in a variety of kitchen layouts. Beautiful in its simplicity, this product has brushed finished surfaces with no visible screws.

### Simple Controls

The intuitive control panel responds to the touch of your finger. LED strip lighting illuminates the entire cooktop surface for the perfect sear or ideal reduction. Range hood settings, including temperature and fan speed, can be controlled via the SmartHQ™ app, with additional voice control options for fan speeds and lighting.

### Easy cleaning

Designed for simple removal, the filters are easy to clean and dishwasher safe, while the glass and stainless steel finish is easily wiped clean. The SmartHQ™ app will notify you when to clean the filter to ensure you get the best performance out of your rangehood.

### Quality Materials

This rangehood comes in a sleek black glass finish with a real stainless steel frame.

## SPECIFICATIONS

### Accessories

Aluminium filter	792942
------------------	--------

### Accessories (sold separately)

Recirculation carbon filter	793602
-----------------------------	--------

### Fan ratings

Maximum air movement	400CFM
Maximum speed sound rating	7.5sones
Speed 1 sound rating	1sones

### Installation and cleaning

Air outlet size	6"
Dishwasher safe filters	2
Ducted	Top extraction
Recirculation	Optional - top extraction

### Performance

Extraction type	Perimeter
-----------------	-----------

Fan speeds	3
Filter type	Mesh with perimeter
Number of filters	2

**Power requirements**

Supply frequency	60Hz
Supply voltage	120V

**Product dimensions**

Depth	11"
Height	12 7/16"
Width	20 7/8"

**Product information**

Control type	Capacitive touch
--------------	------------------

**Ventilation features**

Auto-off/Run-on timer	•
Dimmable lights	•
Filter cleaning alert	•
Light type	LED strip
Timer function	•
Wi-Fi connectivity	•

**Warranty**

Parts and labor	2 years
-----------------	---------

SKU	50205
-----	-------

The product dimensions and specifications in this page apply to the specific product and model. Under our policy of continuous improvement, these dimensions and specifications may change at any time. You should therefore check with Fisher & Paykel's Customer Care Centre to ensure this page correctly describes the model currently available. Fisher & Paykel Appliances Ltd 2020

**Where applicable:**

All appliances use energy, and energy usage typically generates carbon emissions. **Fisher & Paykel Appliances' In-use Energy Carbon Emissions Estimate** indicates carbon emissions from a product's in-use energy. This is calculated either annually or per cycle, using the product's market-specific energy label energy consumption data multiplied by the carbon emissions factor for energy in your country or region.

Our In-use Energy Carbon Emissions Estimate is designed to assist customers in making informed purchasing decisions when comparing different Fisher & Paykel products. For example, a heat pump dryer typically has a lower In-use Energy Carbon Emissions Estimate than a vented dryer.

**Other product downloads available at fisherpaykel.com**

- [↓](#) Service & Warranty
- [↓](#) Guía del usuario ES
- [↓](#) Guide d'utilisation FR
- [↓](#) User Guide Integrated Insert Rangehood EN
- [↓](#) Guide d'installation FR
- [↓](#) Guía de instalación SP
- [↓](#) Installation Guide Insert Rangehood EN
- [↓](#) Preliminary Specification Guide
- [↓](#) Data Sheet Insert Rangehood



**A PEACE OF MIND SALE**

24 Hours 7 Days a Week Customer Support

T 1.888.936.7872 [Wwww.fisherpaykel.com](http://www.fisherpaykel.com)