

Single DishDrawer™ Dishwasher, Tall, Sanitise

Series 9 | Contemporary

Stainless Steel



Created with extra height for large dishes and designed to be placed anywhere in your kitchen, for loading dishes with minimal bending.

- Designed to be installed under your benchtop, with a recessed handle for a seamless look
- Six wash programs, as well as additional Quick wash, Sanitise and Extra Dry modifiers
- With extra height for taller dishes, and customisable internal shelving

- Wi-Fi enabled and works with the SmartHQ™ app for remote control and notifications

DIMENSIONS

Height	454mm
Width	599mm
Depth	573mm

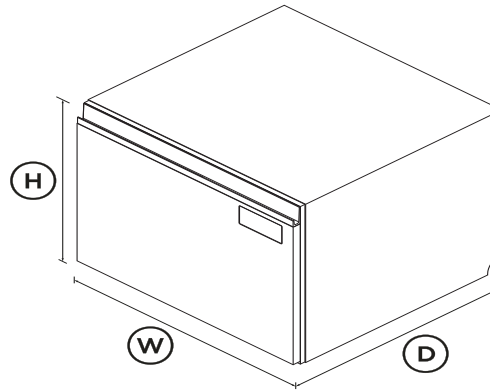

FEATURES & BENEFITS

Seamless fit

Our built-under DishDrawer™ Dishwashers are installed flush under your benchtop with the option of a custom kickstrip, ensuring minimal gaps. Designed to match the Fisher & Paykel family of kitchen appliances with a recessed handle for a streamlined look.

Designed for real life

Designed to make everyday life simpler, DishDrawer™ Dishwashers can be distributed throughout the kitchen to support patterns of use. As easy to open and close as kitchen drawers, they can be conveniently positioned at bench height for ease of loading and minimal bending.

Easy to load

Designed to fit seven place settings, with foldable racking to fit taller dishes up to 310mm. Flexible racking allows you to make adjustments to fit in a variety of dishes.

Quick, Sanitise and Extra Dry options

The Quick wash modifier delivers a faster wash while maintaining performance. The Sanitise option provides extra protection, killing 99.9% of bacteria* in the final rinse. The Extra Dry setting is perfect for plastic dishes. *Certified to NSF/ANSI Standard 184

Quiet performer

Running at a very low decibel rating, these DishDrawer™ Dishwashers do their job without making a fuss. The combination of intelligent technology and simple mechanics means greater reliability and excellent wash performance.

Designed to match

DishDrawer™ Dishwashers are designed to match the Fisher & Paykel family of kitchen appliances, with matching handles, premium styling and quality materials for a stylish finish in your kitchen.

SPECIFICATIONS

Accessories

- Cutlery basket
- Knife clip and multipurpose

Capacity and loading

Accommodates round plates **310mm**

Adjustable height, foldable	•
Fold down tines	•
Pitch adjustable tines	•
Place settings per drawer	7

Consumption

Energy rating	3.5 star
Energy usage	136 kWh/year
In-use energy carbon	18.4kgCO2e/year
Water consumption (per wash)	6.9L
Water efficiency	4.5 star (WELS)

Controls

Energy saving delay start	•
Internal wash selector	•
Keylock	•
Knock to pause	•
Rinse aid indicator light	•
Wi-Fi connectivity	•

Features

Fan assisted drying	•
Flood protection	•
Flow through detergent	•
Motor type	BLDC
Quiet operation	•
SmartDrive™ technology	•

Performance

Noise emissions	42dBA
-----------------	-------

Power requirements

Amperage	5A
Supply frequency	50Hz
Supply voltage	220 - 240V

Product dimensions

Depth	573mm
Height	454mm
Width	599mm

Warranty

Parts and labour	2 years
------------------	---------

Wash Program Modifiers

Extra Dry	•
Quick	•
Sanitise	•
Wash modifiers	3

Wash Programs

Delicate	•
Eco	•
Fast	•
Heavy	•
Medium	•
Rinse	•
Wash programs	6

Water connection

Water pressure	30kPa - 1000 kPa
Water supply	3/4" BSP (20mm) Connector

SKU	82883
-----	-------

The product dimensions and specifications in this page apply to the specific product and model. Under our policy of continuous improvement, these dimensions and specifications may change at any time. You should therefore check with Fisher & Paykel's Customer Care Centre to ensure this page correctly describes the model currently available. ? Fisher & Paykel Appliances Ltd 2020

Other product downloads available at fisherpaykel.com



Service & Warranty



Energy Label DishDrawer™ Dishwasher



User Guide DishDrawer™ Dishwasher



Wash Program Data ASNZS DishDrawer™ Dishwasher



Installation Guide Single DishDrawer™ Dishwasher



Preliminary Specification Guide Single DishDrawer™ Dishwasher



A PEACE OF MIND SALE

24 Hours 7 Days a Week Customer Support

T 0800 372 273 [Wwww.fisherpaykel.com](https://www.fisherpaykel.com)