

FISHER & PAYKEL

DOWNDRAFT INDUCTION COOKTOP



MINIMAL

CID834DTB4

USER GUIDE

AA BI SG

CONTENTS

Safety and warnings	5
First use	10
Safety features	12
Cookware	13
Using your induction zones	15
SmartZones	17
PowerBoost	19
GentleHeat	20
Auto RapidHeat	21
Using the timer	23
Cooking guide	25
Using the extractor	27
Care and cleaning	29
Maintenance alerts	32
Troubleshooting	34
Service and warranty	37

Registration

To register your appliance visit our website: fisherpaykel.com/register

⚠ WARNING!



Hot Surface Hazard

Failure to follow this advice may result in serious injury.

- DO NOT TOUCH SURFACE UNITS OR AREAS NEAR UNITS - Surface units may be hot even though they are dark in colour.
- During use, accessible parts of this appliance will become hot enough to cause burns.
- Never leave metal objects (such as kitchen utensils) or empty pans on the cooktop as they can become hot very quickly.
- Magnetisable metal objects worn on the body may become hot in the vicinity of the cooktop. Gold or silver jewellery will not be affected.
- Handles of saucepans may be hot to touch. Check saucepan handles do not overhang other cooking zones that are on. Keep handles out of reach of children.

⚠ WARNING!



Electrical Shock Hazard

Failure to follow this advice may result in electrical shock or death.

- Switch the power to the cooktop off at the wall before cleaning or maintenance.
- Do not cook on a broken or cracked cooktop. If the glass should break or crack, switch the appliance off immediately at the mains power supply (wall switch) and contact a qualified technician.

⚠ WARNING!



Fire Hazard

Failure to follow this advice may result in serious injury.

- Unattended cooking on a hob with fat or oil can be dangerous and may result in fire.
- NEVER try to extinguish a fire with water, but switch off the appliance and cover flame, eg with a lid or fire blanket, or use dry chemical or foam-type extinguisher.
- Do not store items on cooking surfaces.

⚠ WARNING!



Health Hazard

Failure to follow this advice may result in death.

- This appliance complies with electromagnetic safety standards. However, persons with cardiac pacemakers or other electrical implants (such as insulin pumps) must consult with their doctor or implant manufacturer before using this appliance to make sure that their implants will not be affected by the electromagnetic field.

READ AND SAVE THIS GUIDE

To reduce the risk of fire, injury to persons or damage when using the appliance, follow the important safety instructions listed below. Read all the guidance before using the appliance. Ensure your appliance is properly installed and grounded by a qualified technician.

WARNING — TO REDUCE THE RISK OF FIRE, ELECTRIC SHOCK, OR INJURY TO PERSONS, OBSERVE THE FOLLOWING:

- a) Use this unit only in the manner intended by the manufacturer. If you have questions, contact the manufacturer.
- b) Before servicing or cleaning unit, switch power off at service panel and lock the service disconnecting means to prevent power from being switched on accidentally. When the service disconnecting means cannot be locked, securely fasten a prominent warning device, such as a tag, to the service panel.

General Use

- Do not leave the heating elements turned on with empty pots and pans or with no pans.
- Never heat a tin or can containing foods without opening it first: it might explode!
- The extracted air must not be conveyed through the same ducts used to extract the fumes generated by gas combustion or other types of combustion devices. Never use the device without the grille properly installed!
- When the device is used together with other devices powered with non-electrical energy, the negative pressure of the room must not exceed 4 Pa (4 x 10⁻⁵ bar).
- There shall be adequate ventilation of the room when the range hood is used at the same time as appliances burning gas or other fuels (not applicable to appliances that only discharge the air back into the room).
- For Australia and New Zealand: Range hoods and other cooking fume extractors may adversely affect the safe operation of appliances burning gas or other fuels (including those in other rooms) due to back flow of combustion gases. These gases can potentially result in carbon monoxide poisoning. After installation of a range hood or other cooking fume extractor, the operation of flued gas appliances should be tested by a competent person to ensure that back flow of combustion gases does not occur.
- Never leave the appliance unattended when in use. Boilover causes smoking and greasy spillovers that may ignite.
- Never use your appliance as a work or storage surface.
- Wear proper apparel — Loose-fitting or hanging garments should never be worn while using the appliance.
- Do not leave any magnetic item, e.g. cutlery, roast dish, etc. on your cooktop, including the cooking zones and user interface.
- Do not place or leave any magnetisable objects (eg credit cards, memory cards) or electronic devices (eg computers, MP3 players) near the appliance, as they may be affected by its electromagnetic field.
- We recommend using plastic or wooden kitchen utensils for cooking with your induction cooktop.
- Storage in or on appliance — Flammable materials should not be stored in an oven or near surface units.
- Do not place or leave aluminum foil on the cooktop.
- Never use your appliance for warming or heating the room.

SAFETY AND WARNINGS

- Do not use water on grease fires – Smother fire or flame or use dry chemical or foam-type extinguisher.
- Use only dry potholders — Moist or damp potholders on hot surfaces may result in burns from steam. Do not let potholder touch hot heating elements. Do not use a towel or other bulky cloth.
- Use proper pan size — Always place pans in the centre of the cooking zone. Select utensils having flat bottoms large enough to cover the surface unit heating element. The use of undersized utensils will expose a portion of the heating element to direct contact and may result in ignition of clothing.
- After use, always turn off the cooking zones and the cooktop as described in this guide (ie by using the touch controls). Do not rely on the pan detection feature to turn off the cooking zones when you remove the pans.
- Do not use a steam cleaner to clean your cooktop.
- Do not place or drop heavy objects on your cooktop.
- Do not stand on your cooktop.
- Do not use pans with jagged edges or drag pans across the ceramic glass surface as this can scratch the glass.
- Do not use scourers or any other harsh/abrasive cleaning agents to clean your cooktop, as these can scratch the ceramic glass.
- Do not operate your cooktop by means of an external timer or separate remote-control system.
- Do not cook on broken cooktop — If cooktop should break, cleaning solutions and spillovers may penetrate the broken cooktop and create a risk of electric shock. Contact a qualified technician immediately.

Child Safety

- Do not allow children to play with the appliance or sit, stand, or climb on it.
- Do not store items of interest to children in cabinets above the appliance. Children climbing on the cooktop could be seriously injured.
- Do not leave children alone or unattended in the area where the appliance is in use. Children of less than 8 years old must be kept away from the appliance unless continuously supervised. This appliance can be used by children aged from 8 years and above, and persons with reduced physical, sensory or mental capabilities or lack of experience and knowledge, if they have been given supervision or instruction concerning the use of the appliance in a safe way and they understand the hazards involved. Cleaning and user maintenance shall not be done by children without supervision.
- This appliance is not intended for use by persons (including children) with reduced physical, sensory or mental capabilities, or lack of experience and knowledge, unless they have been given supervision or instruction concerning use of the appliance by a person responsible for their safety;
- Children should be supervised to ensure they do not play with the appliance

Cleaning

- Clean cooktop with caution — If a wet sponge or cloth is used to wipe spills on a hot cooking area, be careful to avoid steam burn. Some cleaners can produce noxious fumes if applied to a hot surface.
- There is a fire risk if cleaning is not carried out in accordance with the instructions.

SAFETY AND WARNINGS

Servicing

- Do not repair or replace any part of the appliance unless specifically recommended in the user guide. All other servicing should be undertaken by a Fisher & Paykel trained and supported service technician or qualified person.
- If the power supply cable is damaged, it must only be replaced by a qualified technician.
- If the appliance is malfunctioning, then contact your Authorised Service Center or Customer Care to arrange for service. Do not use your appliance until it has been repaired by a Fisher & Paykel authorised technician.
- **CAUTION:** The cooking process has to be supervised. A short term cooking process has to be supervised continuously.

Standard Requirements

- This induction cooktop generates and uses ISM frequency energy that heats cookware by using an electromagnetic field. It has been tested and complies with Part 18 of the FCC Rules for ISM equipment. This induction cooktop meets the FCC requirements to minimise interference with other devices in residential installation. Induction cooktops may cause interference with television or radio reception. If interference occurs, the user should try to correct the interference by:
 - Relocating the receiving antenna of the radio or television
 - Increasing the distance between the cooktop and the receiver
 - Connecting the receiver into an outlet different than the receiver.

FIRST USE

Cooktop overview

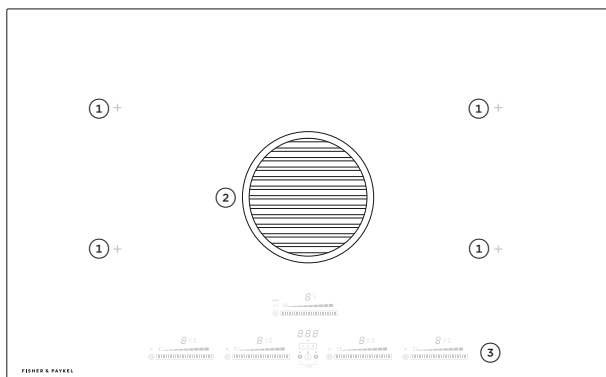

COOKTOP FEATURES

- ① Induction zones
- ② Extractor
- ③ Control panel

Control panel overview

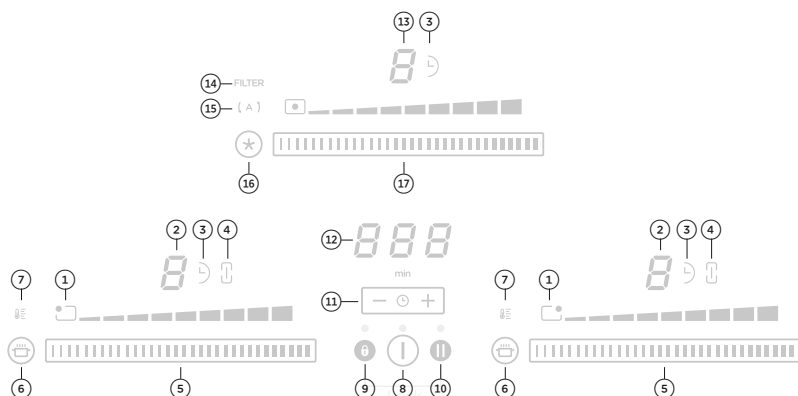

CONTROL PANEL FEATURES

- | | | |
|--------------------------|-----------------------|--|
| ① Cooking zone indicator | ⑧ Product On/Off | ⑮ Auto-extraction indicator |
| ② Cooking zone display | ⑨ Keylock / Childlock | ⑯ Auto-function selector and filter saturation reset |
| ③ Zone timer indicator | ⑩ Pause / Childlock | ⑰ Extraction speed selector |
| ④ Bridged zone indicator | ⑪ Timer control | |
| ⑤ Zone heat selector | ⑫ Main display | |
| ⑥ Gentle heat | ⑬ Extraction display | |
| ⑦ Gentle heat indicator | ⑭ Filter indicator | |

FIRST USE

Display overview

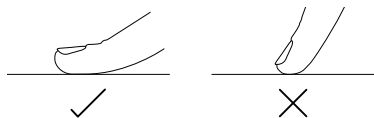

Touch display

Your cooktop is operated using an intuitive touch display. Use the control panel to navigate cooking settings.

Using the touch controls

Use the ball of your finger, not its tip. The controls respond to touch, so pressure is not needed.

ZONE DISPLAY	DESCRIPTION
8	Cooking zone off (not activated)
0	Cooking zone on (activated but not operating)
1 9	Power levels
P	PowerBoost function
H	Hot Surface indicator
U	Pan detection indicator
u	Gentle heat indicator
L	Childlock indicator
	Pause function
A	Auto RapidHeat function

SAFETY FEATURES

The cooktop controls can be locked for cleaning and to prevent unintended use. When the cooktop is locked the controls and cooktop display will remain unresponsive.

Keylock



ACTIVATING KEYLOCK

Ensure all cooking zones have been turned to **OFF**. Touch and hold the keylock control . The indicator above the keylock control will illuminate indicating that the controls are locked.





DISABLING KEYLOCK

To unlock the cooktop, touch and hold the keylock control . The indicator light above the control will dim. Your cooktop is now unlocked.

Childlock





ACTIVATING CHILDLCK

Ensure cooktop is **OFF** and all cookware is removed. Touch and hold  and .  will illuminate in the display indicating that the controls are locked.



DISABLING CHILDLCK

To unlock the cooktop, touch and hold  and . The indicator will dim. Your cooktop is now unlocked.

COOKWARE

Cookware size

For optimal performance, ensure the size of the cookware is suitable for the zone in use.

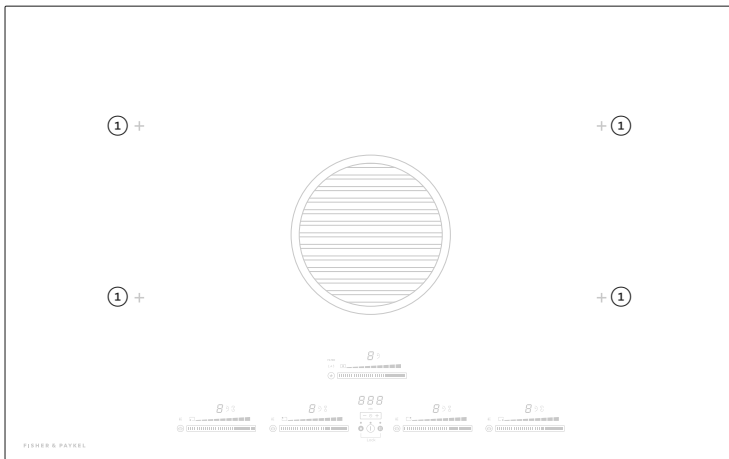

Cooking zone		Min. pan size*	Power**	Powerboost
① Smartzone	unbridged	110mm	2100 W	3000 W
	bridged	230mm	3700 W	n/a

* Recommended

**Total max power 7400 W

COOKWARE

Induction cookware

The quality of your cookware can affect cooking performance. Only use induction-compatible cookware that has been specifically designed for induction cooking. Look for the induction symbol on the packaging or the bottom of the pan.

Suitable cookware material:

- stainless steel – with a magnetic base or core
- aluminium and copper – with a magnetic base or core
- cast iron
- steel
- enamelled steel.

Unsuitable cookware material:

- aluminium or copper – without a magnetic base
- glass
- wood
- porcelain
- ceramic or earthenware.

To check if cookware material is suitable for induction use, carry out a magnet test:

Move a magnet across the base of the pan. If the magnet is attracted, the pan is induction suitable. Ensure attraction is consistent across the base of the pan. If there are gaps, such as an indented manufacturer's logo, then the performance will be impaired.

If you do not have a magnet, fill the pan with some water and refer to section 'Using your induction zones'. If \underline{U} does not flash and the water is heating, pan is suitable.

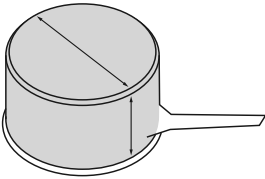

Quickest heating Performance

High content of ferromagnetic material. Heating area is consistent across the base and up the sides of pan.

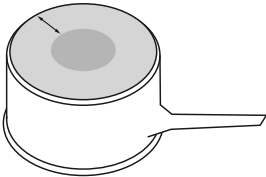

Average heating Performance

Reduced area of ferromagnetic material. Reduced zone of heating, results in poor performance and slower heating.

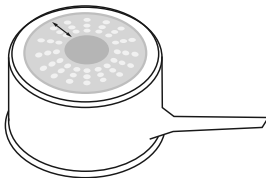

Slow heating Performance

Very limited area of ferromagnetic material. Results in very slow heating performance.

Note: This type of pot is good for very delicate tasks such as melting chocolate, as heating is very slow.

Ensure the base of your cookware is smooth, sits flat against the glass, and is similar in size as the cooking zone. A small pot on a large cooking zone may not be detected. Always centre your pan on the cooking zone and lift pans off the cooktop – do not slide, or they may scratch the glass.

USING YOUR INDUCTION ZONES

To begin cooking

1

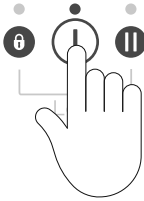

Press the **ON/OFF** control. The indicator light above the control will glow.

2

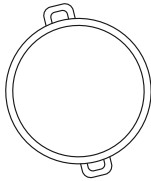

Place a suitable pan on the desired cooking zone. Ensure the bottom of the pan and the surface of the cooking zone are clean and dry.

Always place small pans in the centre of the cooking zone.

3

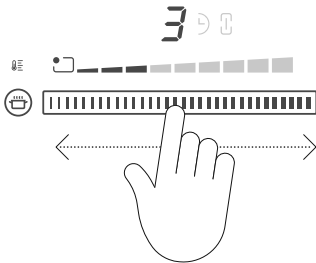

Select a heat setting by touching or sliding the setting selector with your finger.

- If you don't select a heat setting within 10 seconds, the cooktop will automatically turn off.
- You can modify the heat setting at any time during cooking.

USING YOUR INDUCTION ZONES

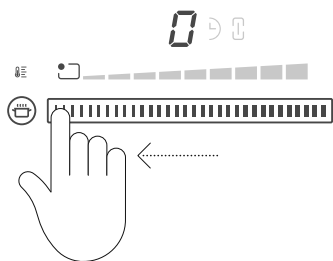

Turn the cooking zone off:

touch or slide the setting selector until **0** shows in the zone display.

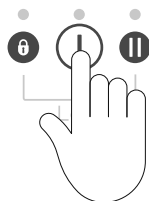

Turn the product off:

touch the ON/OFF control.

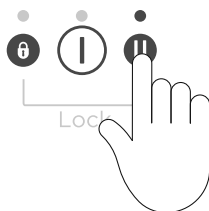

Pause cooking:

touch **||** to pause all cooking functions, **||** will show in the main display. To unpause, press **||** again followed by the desired setting selector.

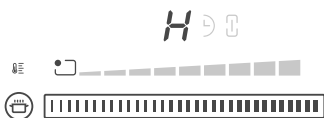

If **H** flashes in the display:

H will flash in the cooking zone display of any zone that is too hot to touch. It will remain illuminated until it has cooled to a safe temperature.

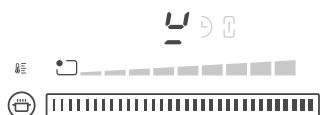

If **U** flashes alternately with the heat setting:

the pan may not be located on the correct cooking zone, it may not be centred correctly or it may not be suitable for induction cooking.

No heating will take place until a suitable pan is detected. The cooktop will turn off after 10 minutes if no suitable pan is used.

SMARTZONES

The SmartZones can accommodate several small pots. These small pots will be detected as one large pot.

The entire SmartZone is activated when a pot is detected. This means that other magnetic items (such as cutlery) sitting in the cooking zone will heat up. Do not leave cutlery or other magnetic items on your cooktop.

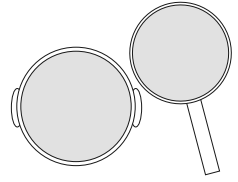

Bridging Zones

The bridging zone function allows you to use two SmartZones together.

- You can only bridge a cooking zone with the one directly behind it.
- There may be a cooler area in the centre of the combined cooking zones. You may need to move food around the pan to ensure even cooking.
- When using bridging zones, it is not possible to use the PowerBoost function.

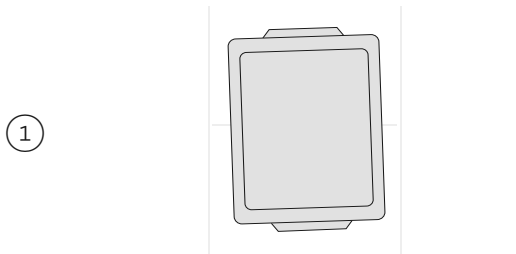

Place the pan over the two zones you wish to use, ensuring both zones are covered.

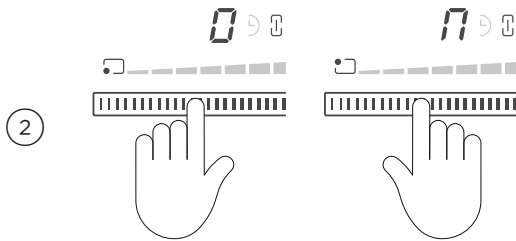

Touch anywhere on the setting selectors of both cooking zones at the same time.

☐ will illuminate in both zones to indicate the bridge-status. *n* will show in the display of the rear cooking zone to indicate it is now controlled by the front control.

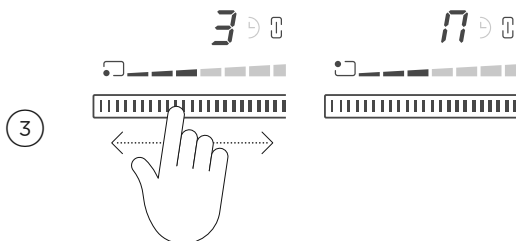

Use the front setting selector to set the heat setting for the combined zone.

The heat setting will be displayed in both bridged zones. The setting indicator will glow on both zones.

SMARTZONES

If no pan is detected on one cooking zone:

The left hand display will still show the selected temperature and the right hand display will still show $\overline{\Pi}$.

If after 10 minutes no pan is detected:

- The bridging function will switch off.
- The cooking zone without a detectable pan will turn off.
- The remaining cooking zone will continue cooking at the selected heat setting.

To cancel bridging

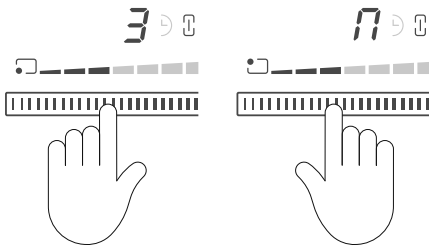

Touch the setting selectors of both bridged cooking zones at the same time. The bridging indicator lights will dim.

Sliding the scale down to $\overline{\Pi}$ will not turn off bridging.

Using the timer in bridged mode:

You may only set one timer for the bridged cooking zone. See 'Using the timer'. The timer indicator $\overline{\Pi}$ will show in both displays.

Cancelling bridging will also cancel the timer for those cooking zones.

POWERBOOST

Using PowerBoost

This feature enables you to sear meat or bring liquid to boil very quickly. When a cooking zone is set to PowerBoost, it uses more than 100% of the power of that particular cooking zone, resulting in a boost of intense heat. PowerBoost heats food and liquids very quickly. Do not leave the cooktop unattended when using this feature.

Setting PowerBoost

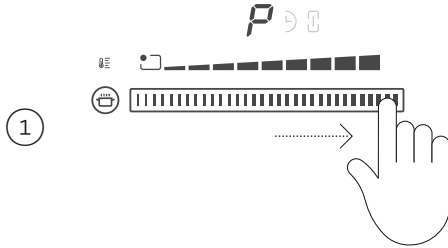

Slide the setting selector to set the cooking zone to the highest heat level. Hold until **P** displayed.

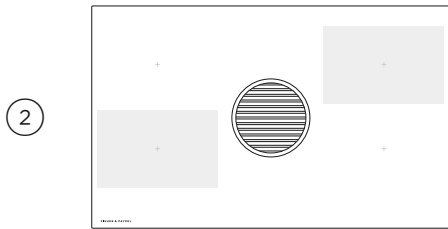

You can set two cooking zones for PowerBoost, as long as one is not behind the other.

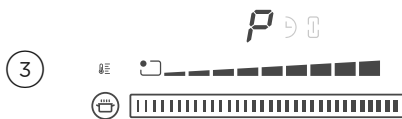

Once PowerBoost is set, the cooking zone will heat more than 100% for 10 minutes. **P** will flash for a few seconds before the cooking zone automatically reduces the heat to setting **B**.



- If one cooking zone is set to PowerBoost and a second cooking zone in front or behind the first cooking zone is accidentally set to PowerBoost, **P** will flash on the first cooking zone to alert that the configuration is not possible and power is automatically decreased.
- When a cooking zone is set for PowerBoost, the other cooking zone in front of or behind may automatically reduce its power level.
- PowerBoost is not available if cooking zones are bridged.

To cancel PowerBoost

Slide the setting selector to a new heat setting or to **0** to turn off the zone.

Using GentleHeat

There are two GentleHeat settings.

- The Low setting  is ideal for the most delicate cooking tasks (such as melting chocolate), as the cooking zone will provide a very low continuous gentle heat.
- The Medium setting  is ideal for keeping cooked food warm and the gentle warming of delicate foods.

Setting up a cooking zone for GentleHeat

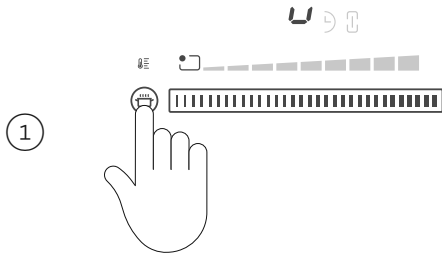

For Low setting

Touch and hold the GentleHeat control on the setting selector.

The Low setting indicator above will glow and  will show in the display.

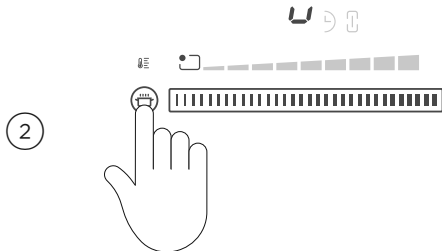

For Medium setting

With Low GentleHeat active, touch the GentleHeat control again to select the Medium setting.

- The Medium setting indicator above will glow and the Low setting indicator goes out.
- Touching the GentleHeat control a third time will switch off the cooking zone.

To exit the GentleHeat setting

Touch or slide the setting selector to a new setting or to  to turn the cooking zone off.

AUTO RAPIDHEAT

Using Auto RapidHeat

This feature enables the cooking zones to:

- heat up food or liquid quickly at the highest setting, and
- reduce the temperature automatically to a pre-selected heat setting.

The amount of time the cooking zone will rapidly heat depends on the selected heat setting.

HEAT SETTING	APPROXIMATE TIME AT RAPID HEAT
1	40 seconds
2	1 minute
3	2 minutes
4	3 minutes
5	4 minutes
6	7 minutes
7	2 minutes
8	3 minutes

Setting a cooking zone for Auto RapidHeat

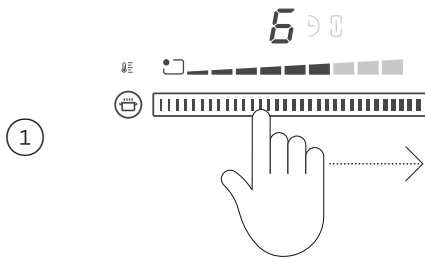

With cooking zone turned on, touch and slide the setting selector to the desired level of reduced heat for the cooking zone.

Keep your finger on the selector.

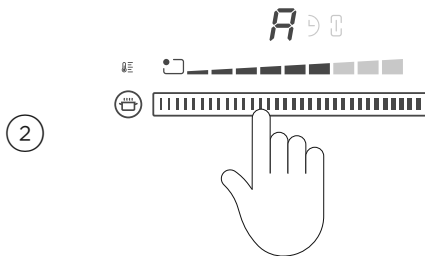

Hold your finger on the selector for 3 seconds until the letter *A* starts to flash alternately with the selected temperature.

- Lift up your finger once setting is complete.

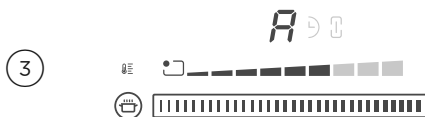

Initially, while the cooking zone is at the highest setting, *A* will flash alternately with your selected lower setting. The length of time at the highest setting depends on the selected lower heat setting.

AUTO RAPIDHEAT

4

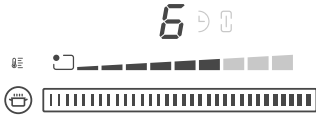

Then, when the period of highest setting is over, **A** will stop flashing and the cooking zone will automatically reduce the heat to your pre-selected lower setting.

If you would like a lower or higher heat setting than you originally selected, simply slide to the new setting and hold until the **A** starts flashing. Alternatively, wait until **A** stops flashing and then modify the heat setting.

To quit Auto RapidHeat setting while **A** is flashing

Either touch or slide the setting selector to a new setting or to  to turn the cooking zone off.

The Auto RapidHeat and PowerBoost features cannot be used together. If you turn PowerBoost on when Auto RapidHeat is already set, the Auto RapidHeat will cancel and PowerBoost will remain.

USING THE TIMER

You can set the timer for up to 1 hour and 59 minutes. The time will be displayed in hours and minutes when the timer is set for longer than 10 minutes.

Using timer as minute minder

The minute minder can be set when not using any cooking or extraction zones. The cooktop will turn off after 10 seconds once the time has been set, but the timer will continue to count down.

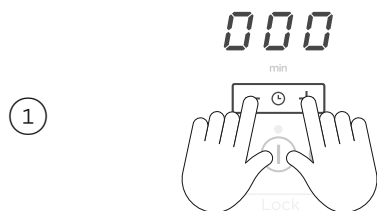

Ensure the cooktop is turned **ON**.

Touch the - and + controls together until 0.00 shows in the timer display and  is illuminated.

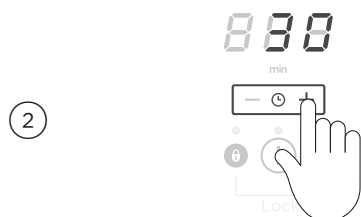

Set the time using the - and + controls.

To scroll through the minutes faster, press and hold - or +. The time can be adjusted at any time during use.

When the set time is up

0.00 will flash and the timer will beep. Touch the - or + controls to stop the beeping.

Setting the timer for individual cooking zones.

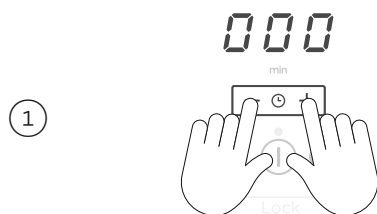

Ensure the cooktop is turned **ON**.

Touch the - and + controls together to activate keylock.

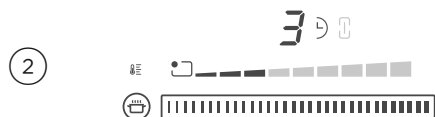

Touch the - and + controls repeatedly until  illuminates for the desired cooking zone.

USING THE TIMER

To cancel a timer setting

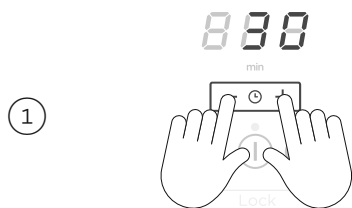

With the cooktop turned on, tap the - and + controls together until the indicator light in the desired cooking zone illuminates.

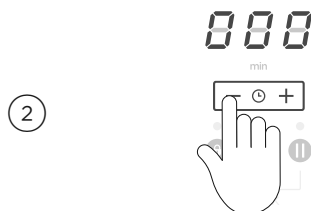

Press and hold the - control until the minute display shows 0. Scrolling down the time to 0 will not turn off the cooking zone.

When you have finished cooking, either touch or slide the setting selector to a new setting or to 0 to turn the cooking zone off.

Setting different times for each of the cooking zones

Setting the minute minder when other timers are set

- ① Tap the - and + controls of the timer together as you cycle through the individual timers \rightarrow for the cooking zones until \odot illuminates. 0000 will show in the timer display.
- ② Touch the - and + controls to set the timer.

When the timer is set

If more than one timer is set, the cooking zone or minute minder indicator with the shortest remaining time setting will glow brightly. Other timer indicators will be dimly lit.

To check the remaining time for another cooking zone

Press the - and + controls together until the indicator in the desired cooking zone window glows brightly.

COOKING GUIDE

Take care when frying: oil and fat heat up very quickly, particularly if you're using PowerBoost. At extremely high temperatures oil and fat will ignite spontaneously and this presents a serious fire risk.

Cooking tips

- When food comes to the boil, reduce the temperature setting.
- Using a lid will reduce cooking times and save energy by retaining the heat.
- Minimise the amount of liquid or fat to reduce cooking times.
- Start cooking on a high setting and reduce the setting when the food has heated through.

Simmering, cooking rice

- Simmering occurs below boiling point, at around 85°C, when bubbles are just rising occasionally to the surface of the cooking liquid. This is the key to delicious soups and tender stews because the flavours develop without overcooking the food. You should also cook egg-based and flour-thickened sauces below boiling point.
- Some tasks, including cooking rice by the absorption method, may require a setting higher than the lowest setting to ensure the food is cooked properly in the time recommended.

Searing steak

To cook juicy flavoursome steaks:

- ① Stand the meat at room temperature for about 20 minutes before cooking.
- ② Heat up a heavy-based frying pan.
- ③ Brush both sides of the steak with oil. Drizzle a small amount of oil into the hot pan and then lower the meat onto the hot pan.
- ④ Turn the steak only once during cooking. The exact cooking time will depend on the thickness of the steak and how cooked you want it. Times may vary from about 2–8 minutes per side. Press the steak to gauge how cooked it is – the firmer it feels the more 'well done' it will be.
- ⑤ Leave the steak to rest on a warm plate for a few minutes to allow it to relax and become tender before serving.

Stir-frying

When stir-frying be careful to lift the pan clear of the surface if tossing the ingredients. Sliding the pan across the cooktop surface may scratch it.

- ① Choose an induction compatible flat-based wok or a large frying pan.
- ② Have all the ingredients and equipment ready. Stir-frying should be quick. If cooking large quantities, cook the food in several smaller batches.
- ③ Preheat the pan briefly and add two tablespoons of oil.
- ④ Cook any meat first, put it aside and keep warm.
- ⑤ Stir-fry the vegetables. When they are hot but still crisp, turn the cooking zone to a lower setting, return the meat to the pan and add your sauce.
- ⑥ Stir the ingredients gently to make sure they are heated through.
- ⑦ Serve immediately.

COOKING GUIDE

Induction heat settings

HEAT SETTING	SUITABILITY
<i>U</i> 	<ul style="list-style-type: none"> melting chocolate, butter, and foods that burn quickly
	<ul style="list-style-type: none"> delicate warming for small amounts of food
1 - 2	<ul style="list-style-type: none"> gentle simmering slow warming
3 - 4	<ul style="list-style-type: none"> reheating rapid simmering cooking rice
5 - 6	<ul style="list-style-type: none"> pancakes
7 - 8	<ul style="list-style-type: none"> sautéing cooking pasta
9	<ul style="list-style-type: none"> stir-frying searing bringing soup to the boil
P	<ul style="list-style-type: none"> boiling water

The settings below are guidelines only. The exact setting will depend on several factors, including your cookware and the amount you are cooking. Experiment with the cooktop to find the settings that best suit you.

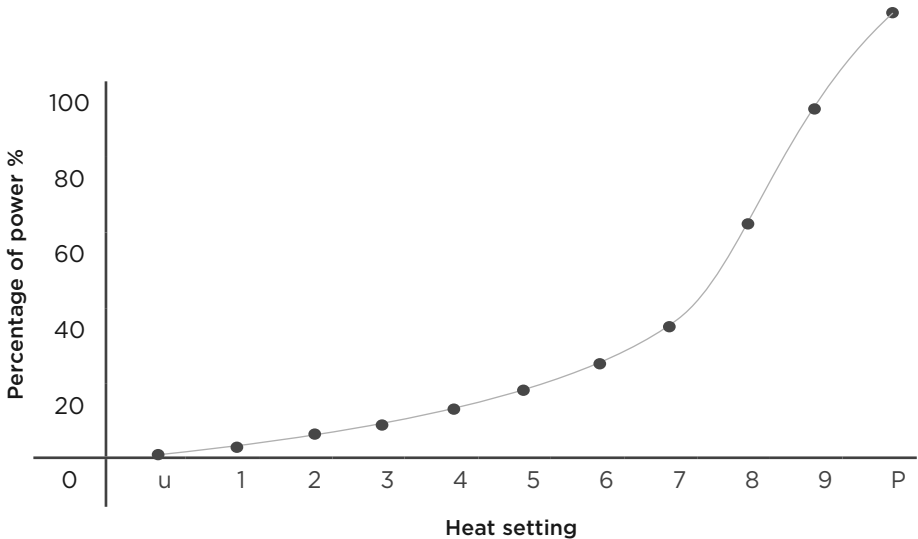

USING THE EXTRACTOR

To start the extractor

1

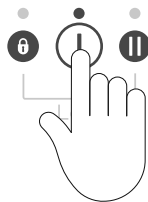

Ensure the cooktop is turned **ON**.

2

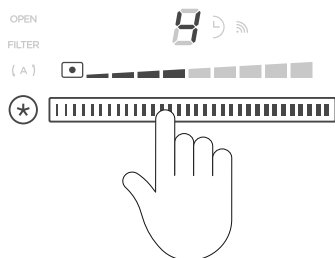

Select an extraction setting by touching or sliding the extraction speed selector with your finger.

- If you don't select an extraction setting within 10 seconds, the extractor will automatically turn off.
- You can modify the extraction setting at any time.

Using Extraction PowerBoost

1

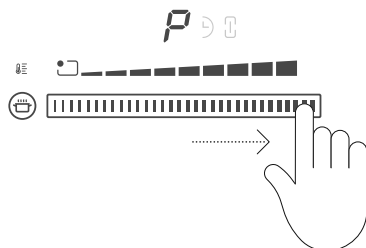

Slide the extraction setting selector to the highest level. Hold until **P** is displayed.

- Once PowerBoost is set, the fan will extract at full speed for 15 minutes. **P** will flash for a few seconds before reducing back to level **9**.

To cancel Extraction PowerBoost

Slide the setting selector to a new setting or to **0** to turn off the fan.

USING THE EXTRACTOR

Using Auto-extraction

This feature enables your cooktop to automatically adjust its extraction speed based on the amount of steam generated during cooking.

Setting Auto-extraction

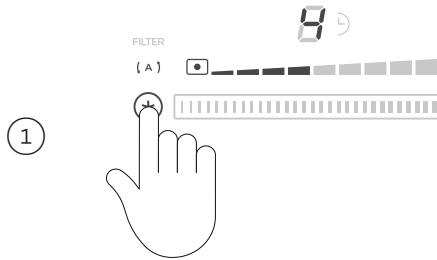

Press . (A) will illuminate to indicate Auto-extraction is active.

To cancel Auto-extraction

You can exit Auto-extraction at any time by pressing again or by manually adjusting the fan speed.

CARE AND CLEANING

WHAT?	HOW?	IMPORTANT!
<p>Everyday soiling on glass (fingerprints, marks, stains left by food or non-sugary spillovers on the glass)</p>	<ol style="list-style-type: none"> ① Switch the power to the cooktop off at the wall. ② Apply cooktop cleaner while the glass is still warm (but not hot) ③ Rinse and wipe dry with a clean cloth or paper towel. ④ Switch the power to the cooktop back on at the wall. 	<ul style="list-style-type: none"> • When the power to the cooktop is switched off, there will be no 'hot surface' indication but the cooking zone may still be hot! Take extreme care. • Heavy-duty scourers, some nylon scourers and harsh/abrasive cleaning agents may scratch the glass. Always read the label to check if your cleaner or scourer is suitable. • Never leave cleaning residue on the cooktop: the glass may become stained.
<p>Boilovers, melts, and hot sugary spills on the glass</p>	<ol style="list-style-type: none"> ① Remove these immediately with a knife or scraper suitable for ceramic glass cooktops, but beware of hot cooking zone surfaces. ② Switch the power to the cooktop off at the wall. ③ Hold the blade or utensil at a 30° angle and scrape the soiling or spill to a cool area of the cooktop. ④ Clean the soiling or spill up with a dish cloth or paper towel. ⑤ Follow steps 2 to 4 for 'Everyday soiling on glass' above. 	<ul style="list-style-type: none"> • Remove stains left by melts and sugary food or spillovers as soon as possible. If left to cool on the glass, they may be difficult to remove or even permanently damage the glass surface. • Cut hazard: when the safety cover is retracted, the blade in a scraper is razor-sharp. Use with extreme care and always store safely and out of reach of children.
<p>Spillover on the touch controls and stainless steel strip</p>	<ol style="list-style-type: none"> ① Switch the power to the cooktop off at the wall. ② Soak up the spill. ③ Wipe the touch control area with a clean damp sponge or cloth. ④ Wipe the area completely dry with a paper towel. ⑤ Switch the power to the cooktop back on at the wall. 	<ul style="list-style-type: none"> • The cooktop may beep and turn itself off, and the touch controls may not function while there is liquid on them. Make sure you wipe the touch control area dry before turning the cooktop back on.

CARE AND CLEANING

Cleaning the filter cover and grease filter

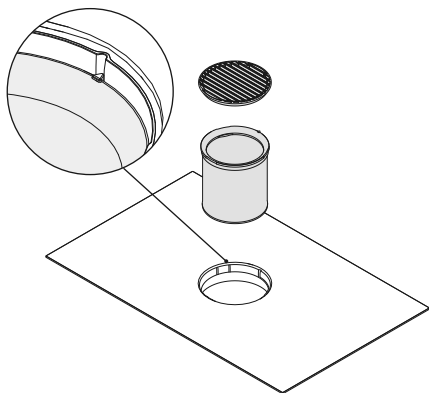

- ① Lift the filter cover out.
- ② Rotate the grease filter clockwise to unlock, then lift out.
- ③ Wash with hot soapy water or in the dishwasher.
- ④ For optimum performance clean the filter and cover once a week.

Cleaning the recirculation filter*

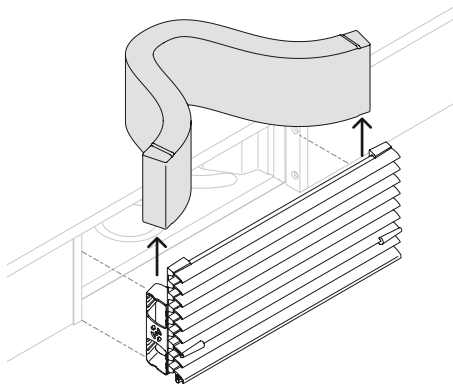

Clean or change the carbon filters every 6-12 months. They may need to be cleaned more frequently depending on intensity of cooking and frequency of cooktop use.

To remove the filters, gently pull the filter cover out from the cabinetry and lift the filter out.

To regenerate the filters, place in the oven at 90°C for 60 minutes then leave to cool.

*Australia and New Zealand models only, when used with optional kit (82236 KIT RECIRC KRCID834)

CARE AND CLEANING

Cleaning the overflow trap

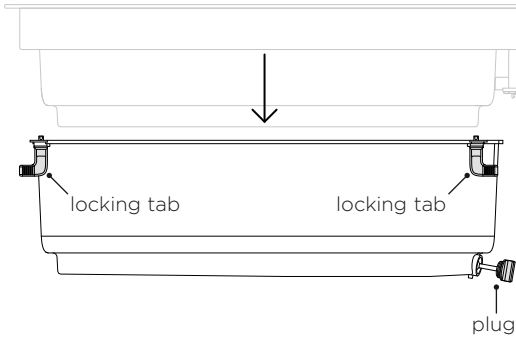

To remove the overflow trap

- ① The overflow trap is located under the cooktop unit.
- ② Remove the plug in the base of the trap to drain any excess grease and liquids into a bucket or container.
- ③ Locate the tabs securing the trap and rotate to face outwards like shown.
- ④ Gently remove the trap and clean in hot soapy water.

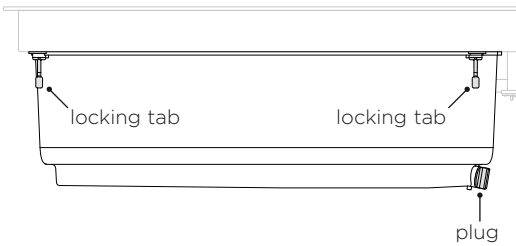

To refit the overflow trap

- ① Position the rear of the trap first then push up firmly.
- ② Push both securing tabs upwards and rotate to lock. Ensure they are both facing forward like shown.
- ③ Ensure the plug in the base of the trap has been refitted.

MAINTENANCE ALERTS

Enable grease filter maintenance alert

By default, the grease filter maintenance alerts will be deactivated.

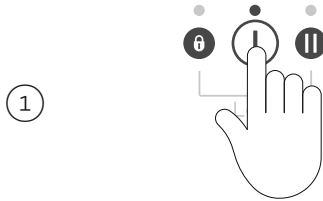

Ensure the cooktop is turned **ON** and all extraction and cooking zones are turned **OFF**.

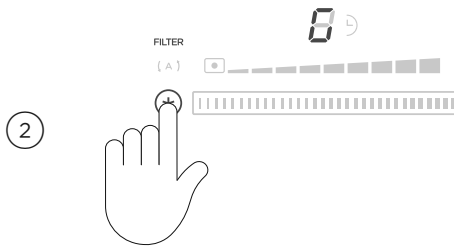

Press and hold **(*)** until **FILTER** illuminates dimly and **F** shows in the display.

To confirm, press the extraction speed area.

Enable carbon filter maintenance alert

By default, the carbon filter maintenance alerts will be deactivated.

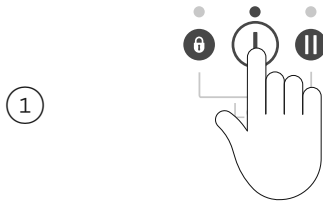

Ensure the cooktop is turned **ON** and all extraction and cooking zones are turned **OFF**.

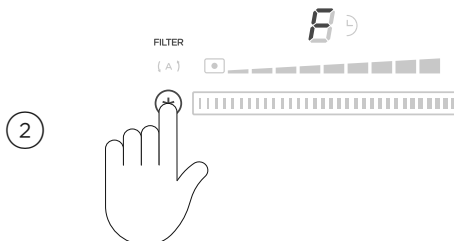

Press and hold **(*)** until **FILTER** illuminates dimly and **F** shows in the display. Press **(*)** again until **F** illuminates.

To confirm, press the extraction speed area.

MAINTENANCE ALERTS

Grease filter maintenance alert

If the grease filter requires cleaning, FILTER will illuminate and 0 will show in the display for the first 10 seconds after turning the cooktop on.

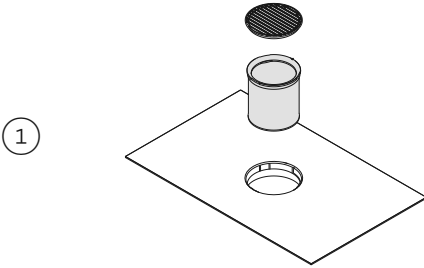

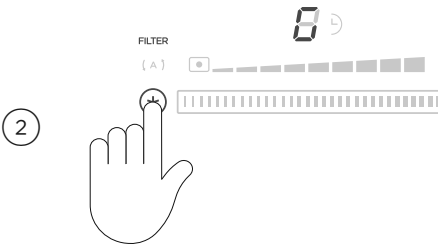

Refer to 'Cleaning the filter cover and grease filter' for guidance.





Press and hold (x) to clear the alert. If FILTER is still illuminated, ensure the grease filter has been cleaned and refitted correctly

TROUBLESHOOTING

PROBLEM	POSSIBLE CAUSES	WHAT TO DO
The cooktop cannot be turned on.	No power.	Make sure the cooktop is connected to the power supply and that it is switched on at the wall. Check whether there is a power outage in your home or area. If you've checked everything and the problem persists, call your Authorised Service Centre or Customer Care.
The touch controls are unresponsive.	The controls are locked.	Unlock the controls. See section 'Safety features' for instructions.
The touch controls are difficult to operate.	There may be a slight film of water over the controls or you may be using the tip of your finger when touching the controls.	Make sure the touch control area is dry and use the ball of your finger when touching the controls.
The glass is being scratched.	Rough-edged cookware.	Use cookware with flat and smooth bases. See 'Cookware'.
	Unsuitable, abrasive scourer or cleaning products being used.	See 'Care and cleaning'.
Some or all displays flash  and there is a continuous beep.	Liquid has spilled onto the touch control area.	Switch the power to the cooktop off at the wall and see 'Care and cleaning' for instructions.
	There are objects (eg utensils) on the touch control area.	Remove the objects from the touch control area.
	Several touch controls are registering continuous contact (eg due to someone resting their hand or arm on the touch control area).	Remove the cause of continuous contact.
Pans do not become hot. The heat setting display comes on, but the  does not flash when I remove a pan.  shows in the timer display when I turn on the cooktop.	The cooktop is in 'Display mode'.	Contact Customer Care or your Authorised Service Centre.

TROUBLESHOOTING

PROBLEM	POSSIBLE CAUSES	WHAT TO DO
Some pans make crackling or clicking noises.	This may be caused by the construction of your cookware (layers of different metals vibrating differently).	This is normal for induction cookware and does not indicate a fault.
The cooktop makes a low humming noise when used on a high heat setting (especially PowerBoost).	This is caused by the technology of induction cooking.	This is normal, but the noise should quieten down or disappear completely when you decrease the heat setting.
Fan noise coming from the cooktop.	A cooling fan built into your cooktop has come on to prevent the electronics from overheating. It may continue to run even after you've turned the cooktop off.	This is normal and needs no action. Do not switch the power to the cooktop off at the wall while the fan is running.
Pans do not become hot and  appears in the display.	The cooktop cannot detect the pan because it is not suitable for induction cooking.	Use cookware suitable for induction cooking. See section 'Cookware'.
	The cooktop cannot detect the pan because it is too small for the cooking zone or not properly centred on it.	Centre the pan and make sure that its base matches the size of the cooking zone.
I have locked the control panel while two cooking zones are bridged and the cooktop has not turned off.	This is normal. The cooking zones will remain inactive, but the indicator lights will remain on.	Unlock the controls, deactivate the bridging zones (by touching the two setting selectors simultaneously) and then lock the cooktop again.
Extraction performance has decreased.	The grease filter needs cleaned.	Clean the grease filter. Refer to 'Maintenance alerts' for details.
	Cookware is blocking extraction.	Tilt cookware lids to allow steam to vent towards the centre of the cooktop.
 flashes in the display when you are trying to set PowerBoost.	PowerBoost is temporarily unavailable because the cooktop needs to protect itself from overheating.	Allow the cooktop to cool down.

TROUBLESHOOTING

PROBLEM	POSSIBLE CAUSES	WHAT TO DO
The cooktop or a cooking zone has turned itself off unexpectedly, a tone sounds and an error code is displayed (typically E or E_r alternating with one or two digits in the cooking zone displays).	Technical fault.	Please note down the error letters and numbers, switch the power to the cooktop off at the wall, and contact your Authorised Service Centre or Customer Care with the error code information.

SERVICE AND WARRANTY

Before you call for service or assistance

Check the things you can do yourself. Refer to the installation instructions and your user guide and check that:

- ① Your product is correctly installed.
- ② You are familiar with its normal operation.

If after checking these points you still need assistance or parts, please refer to the Service & Warranty book for warranty details and your nearest Authorised Service Centre, Customer Care, or contact us through our website www.fisherpaykel.com.

Complete and keep for safe reference:

Model _____

Serial No. _____

Purchase Date _____

Purchaser _____

Dealer _____

Suburb _____

Town _____

Country _____

FISHERPAYKEL.COM

© Fisher & Paykel Appliances 2021. All rights reserved.

The models shown in this guide may not be available in all markets
and are subject to change at any time.

The product specifications in this guide apply to the specific products and
models described at the date of issue. Under our policy of continuous product
improvement, these specifications may change at any time.

For current details about model and specification availability in your country,
please go to our website or contact your local Fisher & Paykel dealer.

592477B 07.21