

# Integrated Insert Rangehood, 90cm

Series 9 | Integrated

Stainless Steel



With edge-to-edge extraction, this efficient, stylish rangehood is perfectly hidden away in your cabinetry.

- With five fan speeds, select the perfect extraction rate for your cooking
- With dimmable LED strip lighting
- 1910m<sup>3</sup>/hr maximum airflow
- Dishwasher safe filters that are easy to remove and clean

## DIMENSIONS

Height	462mm
Width	880mm
Depth	480mm

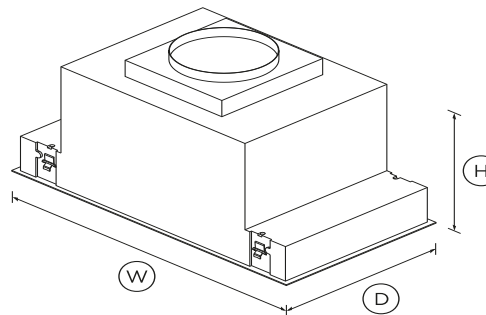

## FEATURES & BENEFITS

### Achieve the invisible

This high quality integrated rangehood seamlessly blends behind cabinetry in a variety of kitchen layouts. Beautiful in its simplicity, this product has brushed finished surfaces with no visible screws.

### Edge to edge extraction

Filters effectively reach edge to edge, maximising the capture and extraction of steam, odours and grease.

### Full surface lighting

LED lighting illuminates the entire cooktop surface so you can ensure you have the perfect sear or ideal reduction. With dimmable lights featuring fade in and fade out features.

### Easy to use

Enjoy fingertip control of LED-illuminated, soft-touch buttons. This model also comes with a remote control for convenience.

### Quiet and efficient

Powered by a brushless DC motor, the Integrated Rangehood operates more efficiently, more reliably and with less noise than units with AC motors.

### Easy cleaning

Multi-layered filters effectively trap grease particles during extraction. Designed for simple removal, they're easy-to-clean and dishwasher safe.

### Simple installation

Designed for simple installation in your kitchen cabinetry, with an adjustable mounting system.

## SPECIFICATIONS

### Fan ratings

Maximum air movement	1910m <sup>3</sup> /hr
Speed 3 sound rating	57dBA

### Installation and cleaning

Dishwasher safe filters	4
Ducted	Vertical only

### Performance

Extraction type	Surface
Fan speeds	5
Filter type	Stainless Steel Baffle

### Power requirements

Supply voltage	230V
----------------	------

---

**Product dimensions**

Depth	<b>480mm</b>
Height	<b>462mm</b>
Width	<b>880mm</b>

---

**Product information**

Control type	<b>Electronic</b>
--------------	-------------------

---

**Ventilation features**

Auto-off/Run-on timer	•
Dimmable lights	•
Filter cleaning alert	•
Light type	<b>LED strip</b>
Number of light settings	<b>5</b>
Over heat sensing	•

---

**Warranty**

Parts and labour	<b>2 years</b>
------------------	----------------

---

SKU	<b>50143</b>
-----	--------------

---

---

**Other product downloads available at fisherpaykel.com**

- [↓](#) Service & Warranty
- [↓](#) User Guide Integrated Rangehood
- [↓](#) Installation Guide
- [↓](#) Data Sheet Insert Rangehood

**A PEACE OF MIND SALE****24 Hours 7 Days a Week Customer Support****T 0800 372 273 W [www.fisherpaykel.com](http://www.fisherpaykel.com)**

The product dimensions and specifications in this page apply to the specific product and model. Under our policy of continuous improvement, these dimensions and specifications may change at any time. You should therefore check with Fisher & Paykel's Customer Care Centre to ensure this page correctly describes the model currently available. ? Fisher & Paykel Appliances Ltd 2020