

FISHER & PAYKEL

**CONVECTION
MICROWAVE OVEN**

CMO-24SS models

**FOUR MICRO-ONDES
À CONVECTION**

Modèles CMO-24SS

**INSTALLATION GUIDE / USER GUIDE
GUIDE D'INSTALLATION / GUIDE D'UTILISATION**

US CA

A MESSAGE TO OUR CUSTOMERS

Thank you for selecting this Over the Range Convection Microwave Oven. Because of this appliance's unique features we have developed this Use and Care Guide. It contains valuable information on how to properly operate and maintain your new appliance for years of safe and enjoyable cooking.

To help serve you better, please fill out and submit your Product Registration by visiting our websites: www.fisherpaykel.com and selecting "PRODUCT REGISTRATION"

In addition, keep this guide handy, as it will help answer questions that may arise as you use your new appliance.

For your convenience, product questions can be answered by a Customer Care Representative at 1-888-936-7872, or email: usa.customercare@fisherpaykel.com

NOTE: Please write the Model and Serial Numbers on this page for references (can be found on bottom left corner of the cavity face).

MODEL NUMBER _____ SERIAL NUMBER _____

NOTE: Inspect the product to verify that there is no shipping damage. If any damage is detected, call the shipper and initiate a damage claim. Fisher & Paykel is not responsible for shipping damage.

DO NOT discard any packing material (box, pallet, straps) until the unit has been inspected.

PRECAUTIONS TO AVOID POSSIBLE EXPOSURE TO EXCESSIVE MICROWAVE ENERGY

- *Do not attempt to operate this microwave oven with the door open since open-door operation can result in harmful exposure to microwave energy. It is important not to damage or tamper with the safety interlocks.*
- *Do not place any object between the microwave oven front face and the door or allow soil or cleaner residue to accumulate on sealing surfaces.*
- *Do not operate the microwave oven if it is damaged. It is particularly important that the microwave oven door close properly and that there is no damage to the: (1) door (bent), (2) hinges and latches (broken or loosened), (3) door seals and sealing surfaces.*
- *The microwave oven should not be adjusted or repaired by anyone except properly qualified service personnel.*

RETAIN THIS MANUAL FOR FUTURE REFERENCE.

CONTENTS

A Message to Our Customers	2	Convection Automatic Operation	29-31
Precautions to Avoid Possible Exposure to Excessive Microwave Energy.....	2	Auto Broil.....	29
Important Safety Instructions.....	4	Auto Roast.....	30
Installation Instructions	6	Auto Bake	31
Grounding Instructions	7	Manual Convection and Automatic Mix Cooking	32-47
Information You Need to Know ...	8-13	Convection Cooking.....	32-36
About Your Microwave Oven	8	Broil.....	36-37
About Children and the Microwave.	8	Slow Cook	37-40
About Microwave Cooking.....	8-9	Automatic Mix Cooking	40-47
About Food.....	9	Other Convenient Features	48-50
About Utensils and Coverings.....	10-13	Multiple Sequence Cooking.....	48
About Safety	13	More or Less Time Adjustment	48
Part Names	14-15	Extra Minute.....	48
Before Operating	16	Help Menu	48-49
To Set the Clock	16	Kitchen Timer.....	50
Stop/Clear	16	Start.....	50
Manual Operation.....	17	Help (Display indicator)	50
Time Cooking.....	17	Demonstration Mode	50
To Set Power Level.....	17	Cleaning and Care.....	51
Manual Defrost.....	17	Specifications.....	52
Microwave Features	18-28	Service Call Check.....	53
Microwave Cooking Principles.....	18	Warranty	54
Defrosting Frozen Foods	18-19		
Reheating.....	19-23		
Defrost.....	24		
Sensor Reheat.....	25-26		
Popcorn.....	26		
Sensor Cook	26-28		

IMPORTANT SAFETY INSTRUCTIONS

When using electrical appliances basic safety precautions should be followed, including the following:

WARNING – To reduce the risk of burns, electric shock, fire, injury to persons or exposure to excessive microwave energy:

1. Read all instructions before using the appliance.
2. Read and follow the specific 'PRECAUTIONS TO AVOID POSSIBLE EXPOSURE TO EXCESSIVE MICROWAVE ENERGY' on page 2.
3. This appliance must be grounded. Connect only to properly grounded outlet. See 'GROUNDING INSTRUCTIONS' on page 7.
4. Install or locate this appliance only in accordance with the provided installation instructions.
5. Some products such as whole eggs and sealed containers—for example, closed glass jars—are able to explode and should not be heated in this microwave oven.
6. Use this appliance only for its intended use as described in this manual. Do not use corrosive chemicals or vapors in this appliance. This type of microwave oven is specifically designed to heat, cook or dry food. It is not designed for industrial or laboratory use.
7. As with any appliance, close supervision is necessary when used by children.
8. Do not operate this appliance if it has a damaged cord or plug, if it is not working properly or if it has been damaged or dropped.
9. This appliance should be serviced only by qualified service personnel.
10. Do not cover or block any openings on the appliance.
11. Do not store or use this appliance outdoors. Do not use this product near water—for example, near a kitchen sink, in a wet basement or near a swimming pool, or similar locations.
12. Do not immerse cord or plug in water.
13. Keep cord away from heated surfaces.
14. Do not let cord hang over edge of table or counter.
15. See door surface cleaning instructions on page 50.
16. To reduce the risk of fire in the microwave oven cavity:
 - a. Do not overcook food. Carefully attend appliance when paper, plastic or other combustible materials are placed inside the microwave oven to facilitate cooking.
 - b. Remove wire twist-ties from paper or plastic bags before placing bag in microwave oven.
 - c. If materials inside the microwave oven should ignite, keep microwave oven door closed, turn microwave oven off and disconnect the power cord or shut off power at the fuse or circuit breaker panel.
 - d. Do not use the cavity for storage purposes. Do not leave paper products, cooking utensils or food in the cavity when not in use.

IMPORTANT SAFETY INSTRUCTIONS

17. Liquids, such as water, coffee or tea are able to be overheated beyond the boiling point without appearing to be boiling. Visible bubbling or boiling when the container is removed from the microwave oven is not always present. THIS COULD RESULT IN VERY HOT LIQUIDS SUDDENLY BOILING OVER WHEN A SPOON OR OTHER UTENSIL IS INSERTED INTO THE LIQUID.

To reduce the risk of injury to persons:

- a. Do not overheat the liquid.
 - b. Stir the liquid both before and halfway through heating it.
 - c. Do not use straight-sided containers with narrow necks. Use a wide-mouthed container.
 - d. After heating, allow the container to stand in the microwave oven for at least 20 seconds before removing the container.
 - e. Use extreme care when inserting a spoon or other utensil into the container.
18. If the microwave oven is installed as a built-in, observe the following instructions:
 - a. Do not mount over a sink.
 - b. Do not store anything directly on top of the appliance surface when the appliance is in operation.
 19. If the microwave oven light fails, consult a FISHER AND PAYKEL AUTHORIZED SERVICER.

SAVE THESE INSTRUCTIONS

INSTALLATION INSTRUCTIONS

UNPACKING AND EXAMINING YOUR MICROWAVE OVEN

Remove all packing materials from inside the microwave oven cavity; however, **DO NOT REMOVE THE WAVEGUIDE COVER**, which is located on the top cavity wall. Read enclosures and **SAVE** this manual.

Check the microwave oven for any damage, such as misaligned or bent door, damaged door seals and sealing surfaces, broken or loose door hinges and latches and dents inside the cavity or on the door. If there is any damage, do not operate the microwave oven and contact your dealer or FISHER AND PAYKEL AUTHORIZED SERVICER.

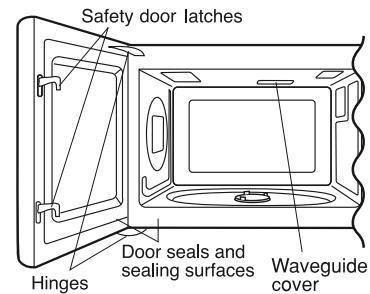

CHOOSING A LOCATION FOR YOUR MICROWAVE OVEN

You will use your oven frequently so plan its location for ease of use. Allow at least 2 inches on the sides, top and at the rear of the oven for air circulation.

Your microwave oven can be built into a cabinet or wall by itself or above wall oven models WOSU-30 or OB30SDEPX1 (Fisher & Paykel), using the appropriate Fisher & Paykel branded Microwave Accessory Trim Kit (CMOTTK). It cannot be built in above conventional gas or electric range or any other wall oven.

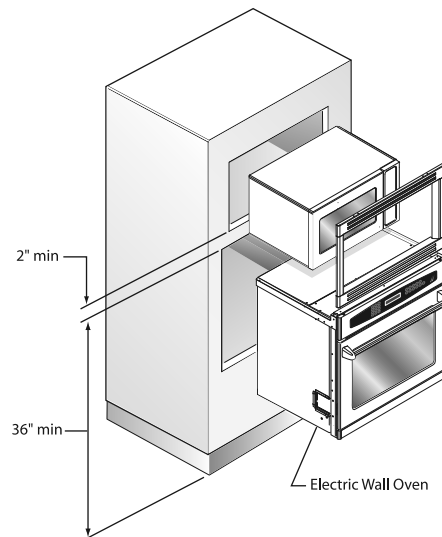

GROUNDING INSTRUCTIONS

This appliance must be grounded. This microwave oven is equipped with a cord which has a grounding wire and grounding plug. It must be plugged into a wall receptacle that is properly installed and grounded in accordance with the National Electrical Code and local codes and ordinances. In the event of an electrical short circuit, grounding reduces risk of electric shock by providing an escape wire for the electric current.

Warning – Improper use of the grounding plug can result in a risk of electric shock.

ELECTRICAL REQUIREMENTS

The electrical requirements are a 120 volt 60 Hz, AC only, 15 amp or more protected electrical supply. It is recommended that a separate circuit serving only this appliance be provided.

The microwave oven is equipped with a 3-prong grounding plug. It must be plugged into a wall receptacle that is properly installed and grounded. Should you only have a 2-prong outlet, have a qualified electrician install a correct wall receptacle.

A short power-supply cord is provided to reduce risk of becoming entangled in or tripping over a longer cord.

EXTENSION CORD

If it is necessary to use an extension cord, use only a 3-wire extension cord that has a 3-blade grounding plug and a 3-slot receptacle that will accept the plug on the microwave oven. The marked rating of the extension cord should be AC 115-120 volt, 15 amp or more.

Be careful not to drape the cord over the countertop or table where it can be pulled on by children or tripped over accidentally.

Notes:

1. If you have any questions about the grounding or electrical instructions, consult a qualified electrician or service person.
2. Neither FISHER & PAYKEL nor the dealer can accept any liability for damage to the microwave oven or personal injury resulting from failure to observe the correct electrical connection procedures.

RADIO OR TV INTERFERENCE

Should there be any interference caused by the microwave oven to your radio or TV, check that the microwave oven is on a different electrical circuit, relocate the radio or TV as far away from the microwave oven as feasible or check position and signal of receiving antenna.

Permanent and Correct Installation

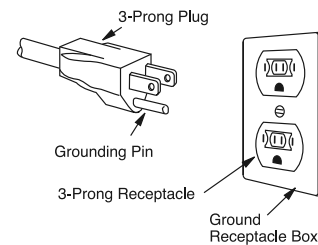

Temporary Use

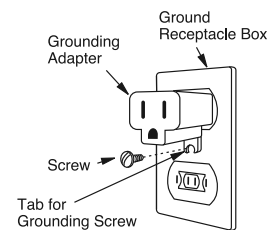

INFORMATION YOU NEED TO KNOW

ABOUT YOUR MICROWAVE OVEN

This manual is valuable: read it carefully and always save it for reference.

NEVER use the microwave oven without the turntable and support nor turn the turntable over so that a large dish could be placed in the microwave oven. The turntable will turn both clockwise and counterclockwise.

ALWAYS have food in the microwave oven when it is on to absorb the microwave energy.

When using the oven at power levels below 100%, you may hear the magnetron cycling on and off.

Condensation is a normal part of microwave cooking. Room humidity and the moisture in food will influence the amount of moisture that condenses in the oven. Generally, covered foods will not cause as much condensation as uncovered ones. Vents on the oven back must not be blocked.

After using convection, automatic mix or broil, you will hear the sound of the cooling fan. The fan may continue to operate as long as 5 minutes, depending on the oven temperature.

Be aware that, unlike microwave-only ovens, convection microwave ovens have a tendency to become hot during convection, automatic mix and broil cooking.

The oven is for food preparation only. It should not be used to dry clothes or newspapers.

Your oven is rated 900 watts using the IEC Test Procedure. In using recipes or package directions, check food at the minimum time and add time accordingly.

ABOUT MICROWAVE COOKING

- Arrange food carefully. Place thickest areas towards outside of dish.
- Watch cooking time. Cook for the shortest amount of time indicated and add more as needed. Food severely overcooked can smoke or ignite.
- Cover foods while cooking. Check recipe or cookbook for suggestions: paper towels, wax paper, microwave plastic wrap or a lid. Covers prevent spattering and help foods to cook evenly.
- Shield with small flat pieces of aluminum foil any thin areas of meat or poultry to prevent overcooking before dense, thick areas are cooked thoroughly.
- Stir foods from outside to center of dish once or twice during cooking, if possible.
- Turn foods over once during microwaving to speed cooking of foods such as chicken and hamburgers. Large items like roasts must be turned over at least once.
- Rearrange foods such as meatballs halfway through cooking both from top to bottom and from the center of the dish to the outside.
- Add standing time. Remove food from microwave oven and stir, if possible. Cover for standing time which allows the food to finish cooking without overcooking.
- Check for doneness. Look for signs indicating that cooking temperatures have been reached.

Doneness signs include:

- Food steams throughout, not just at edge.
- Center bottom of dish is very hot to the touch.
- Poultry thigh joints move easily.
- Meat and poultry show no pinkness.
- Fish is opaque and flakes easily with a fork.

INFORMATION YOU NEED TO KNOW

ABOUT CHILDREN AND THE MICROWAVE

Children below the age of 7 should use the microwave oven with a supervising adult very near to them. Between the ages of 7 and 12, the supervising adult should be in the same room.

The child must be able to reach the microwave oven comfortably; if not, he/she should stand on a sturdy stool.

At no time should anyone be allowed to lean or swing on the microwave oven door.

Children should be taught all safety precautions: use potholders, remove coverings carefully, pay special attention to packages of crisp food because they may be extra hot.

Don't assume that because a child has mastered one cooking skill he/she can cook everything.

Children need to learn that the microwave oven is not a toy. See page 48 for Safety Lock feature.

ABOUT FOOD

FOOD	DO	DON'T
Eggs, sausages, nuts, seeds, fruits & vegetables	<ul style="list-style-type: none"> • Puncture egg yolks before cooking to prevent 'explosion'. • Pierce skins of potatoes, apples, squash, hot dogs and sausages so that steam escapes. 	<ul style="list-style-type: none"> • Don't cook eggs in shells. • Don't reheat whole eggs. • Don't dry nuts or seeds in shells.
Popcorn	<ul style="list-style-type: none"> • Use specially bagged popcorn for the microwave oven. • Listen while popping corn for the popping to slow to 1 or 2 seconds or use special Popcorn pad. 	<ul style="list-style-type: none"> • Don't pop popcorn in regular brown bags or glass bowls. • Don't exceed maximum time on popcorn package.
Baby food	<ul style="list-style-type: none"> • Transfer baby food to small dish and heat carefully, stirring often. Check temperature before serving. • Put nipples on bottles after heating and shake thoroughly. 'Wrist' test before feeding. 	<ul style="list-style-type: none"> • Don't heat disposable bottles. • Don't heat bottles with nipples on. • Don't heat baby food in original jars.
General	<ul style="list-style-type: none"> • Cut baked goods with filling after heating to release steam and avoid burns. • Stir liquids briskly before, during and after heating to avoid 'eruption'. • Use deep bowl, when cooking liquids or cereals, to prevent boilovers. 	<ul style="list-style-type: none"> • Don't heat or cook in closed glass jars or air tight containers. • Don't heat cans in the microwave as harmful bacteria may not be destroyed. • Don't deep fat fry. • Don't dry wood, gourds, herbs or wet papers.

INFORMATION YOU NEED TO KNOW

ABOUT UTENSILS AND COVERINGS

UTENSILS AND COVERINGS	MICROWAVE ONLY	CONVECTION BROIL, SLOW COOK	HIGH MIX/ROAST LOW MIX/BAKE
Aluminum foil	YES. Small flat pieces of aluminum foil placed smoothly on food can be used to shield areas from cooking or defrosting too quickly. Keep foil at least 1 inch from walls of oven.	YES. For shielding	YES. For shielding
Aluminum containers	YES. Can be used if 3/4 filled with food. Keep 1 inch away from walls and do not cover with foil.	YES. Broil-No cover	YES. Can be used if 3/4 filled with food. Keep 1 inch away from walls and do not cover with foil.
Browning dish	YES. Do not exceed recommended preheating time. Follow manufacturer's directions.	NO	NO
Glass ceramic (Pyroceram®)	YES. Excellent	YES. Excellent	YES. Excellent
Glass, heat-resistant	YES. Excellent.	YES. Excellent	YES. Excellent
Glass, non-heat-resistant	NO	NO	NO
Lids, glass	YES	YES. Broil-No cover	YES
Lids, metal	NO	YES. Broil-No cover	NO
Metal cookware	NO	YES.	YES. Do not use metal covering.
Metal, misc: dishes with metallic trim, screws, bands, handles. Metal twist ties	NO	NO	NO
Oven cooking bags	YES. Good for large meats or foods that need tenderizing. DO NOT use metal twist ties.	YES. Broil-No cover	YES. DO NOT use metal twist ties.

INFORMATION YOU NEED TO KNOW

ABOUT UTENSILS AND COVERINGS

UTENSILS AND COVERINGS	MICROWAVE ONLY	CONVECTION BROIL, SLOW COOK	HIGH MIX/ROAST LOW MIX/BAKE
Paper plates	YES. For reheating	NO	NO
Paper towels	YES. To cover for reheating and cooking. Do not use recycled paper towels which may contain metal filings.	NO	NO
Paper, ovenable	YES	YES. For temperatures up to 400°F. Do not use for broiling.	YES. For temperatures up to 400°F.
Microwave-safe plastic containers	YES. Use for reheating and defrosting. Some microwave-safe plastics are not suitable for cooking foods with high fat and sugar content. Follow manufacturer's directions.	NO	NO
Plastic, Thermoset®	YES	YES. Are heat resistant up to 425°F. Do not use for broiling.	YES
Plastic wrap	YES. Use brands specially marked for microwave use. DO NOT allow plastic wrap to touch food. Vent so steam can escape.	NO	NO
Pottery, porcelain stoneware	YES. Check manufacturer's recommendation for being microwave safe.	YES	YES. Must be microwave safe AND ovenable.
Styrofoam	YES. For reheating	NO	NO
Wax paper	YES. Good covering for cooking and reheating	NO	NO
Wicker, wood, straw	YES. May be used for short periods of time. Do not use with high fat or high sugar content foods. Could char.	NO	NO

INFORMATION YOU NEED TO KNOW

DISH CHECK

If you wish to check if a dish is safe for microwaving, place the empty dish in the oven and microwave on HIGH for 30 seconds. If the dish becomes very hot, do NOT use it for microwaving.

ACCESSORIES

There are many microwave accessories available for purchase. Evaluate carefully before you purchase so that they meet your needs. A microwave-safe thermometer will assist you in determining correct doneness and assure you that foods have been cooked to safe temperatures when using microwave-only cooking. Fisher & Paykel is not responsible for any damage to the oven when accessories are used.

MICROWAVE UTENSILS

The ideal material for a microwave utensil allows energy to pass through the container and heat the food. Many common household items, such as paper plates and glass or plastic bowls, are good choices for warming foods.

When a utensil is used for cooking, it must also be able to withstand contact with hot food or boiling liquid.

Dual-purpose, heat-resistant paper and plastic utensils can be used in microwave and conventional ovens. Look for materials that are marked 'safe for microwave or conventional oven up to 400°F'. Many traditional cooking containers, such as casseroles and measuring cups, are also suitable for microwaving.

Oven-glass and glass ceramic (Pyroceram®) utensils can be used for microwaving, serving and storing. Oven-glass utensils are inexpensive and widely available. Use them for measuring, mixing and microwaving. Choose clear glass for pies, cakes and breads, so you can easily check for doneness through the bottom of the dish.

Microwave-safe Dish Test. If you are not sure whether your dish is safe to use in the microwave oven, use this test. Place the dish in the oven. Measure 1/2 to 1 cup water in glass cup. Place on or beside dish. Microwave at HIGH (100%) for 1 to 2 minutes. If dish remains cool, it is suitable for microwaving. Do not use this test for plastic and metal.

Pottery, stoneware and porcelain offer the convenience of cook-and-serve versatility. Serving bowls, platters, casseroles, plates and cups are practical and attractive. Look for dishware that is marked 'microwave-safe'. If you are not sure if your dish is safe to use, use the dish test above.

Plastic cookware (Thermoset®) marked microwave-safe is designed for microwave oven and conventional oven use and can withstand temperatures up to 400°F. Follow manufacturer's recommendations.

Plastic storage containers and tableware marked 'dishwasher-safe' and Styrofoam® may be used for short-term heating to serving temperature. Do not use them for cooking raw foods or for heating foods high in fat or sugar, since they distort at fairly low temperatures. 'Original' Tupperware® may melt or distort; Ultra 21® lines from Tupperware are designed for microwave use.

Plastic wrap or plastic food-storage bags should not be used for cooking.

Paper plates, hot drink, cups, towels and napkins are good choices for short-term cooking and heating. Avoid recycled paper, which may contain metal chips, and wax-coated paper cups or plates. Paper baking cups absorb excess moisture and save clean-ups. Plain white paper towels are excellent for warming breads, cooking bacon or covering to prevent splatters. Wax paper can be used as a light, nonstick cover that holds in steam; it also prevents splattering for dishes such as chili or spaghetti.

Dual-purpose paper products, such as ovenable paperboard containers, are versatile choices. They are freezer-proof and safe for both microwave and conventional ovens up to 400°F.

INFORMATION YOU NEED TO KNOW

Metal, such as small pieces of aluminum foil, may be used to shield small areas of food (wingtips, leg ends, breast bones) from overcooking and overdefrosting. Metal reflects energy away from food and slows cooking. Special microwave thermometers design to be left in the oven during cooking and temperature probes are also valuable tools. Shallow (no more than 1³/₄ inches in depth) foil convenience-food trays may be used. The amount of metal used must be in proportion to the volume of food; foil trays should be two-thirds to three-fourths full. Always keep metal at least 2 inches away from oven walls and ceiling to prevent arching.

Not Recommended for Use in the Microwave Oven Do not use metal pots, pans or bakeware, metal twist ties or dishes with metallic trim. Also avoid utensils with metal screws, bands or handles, metal reinforcement in some baskets or wicker-wrapped handles and conventional meat or candy thermometers. Melamine® or Centura® tableware, plastics that may be sensitive to hot foods, leaded crystal, antique or delicate glassware, fine bone china and ceramic mugs or cups with glued-on handles, brown paper bags and recycled paper products are not recommended for any microwave cooking use.

ABOUT SAFETY

- Check foods to see that they are cooked to the United States Department of Agriculture's recommended temperatures.

To test for doneness, insert a meat thermometer in a thick or dense area away from fat or bone. Never leave the thermometer in the food during cooking, unless it is approved for microwave oven use.

TEMP	FOOD
160°F / 71°C	For fresh pork, ground meat, boneless white poultry, fish, seafood, egg dishes and frozen prepared food.
165°F / 74°C	For leftover, ready-to-reheat refrigerated, and deli and carry-out 'fresh' food.
170°F / 77°C	White meat of poultry.
180°F / 82°C	Dark meat of poultry.

- **ALWAYS** use potholders to prevent burns when handling utensils that are in contact with hot food. Enough heat from the food can transfer through utensils to cause skin burns.
- Avoid steam burns by directing steam away from the face and hands. Slowly lift the farthest edge of a dish's covering and carefully open popcorn and microwave oven cooking bags away from the face.
- Stay near the microwave oven while it's in use and check cooking progress frequently so that there is no chance of overcooking food.
- **NEVER** use the cavity for storing cookbooks or other items.
- Select, store and handle food carefully to preserve its high quality and minimize the spread of foodborne bacteria.
- Keep waveguide cover clean. Food residue can cause arcing and/or fires.
- Use care when removing items from the microwave oven so that the utensil, your clothes or accessories do not touch the safety door latches.
- Keep aluminum foil used for shielding at least 1 inch away from walls, ceiling and door of microwave oven.

PART NAMES

MICROWAVE OVEN PARTS

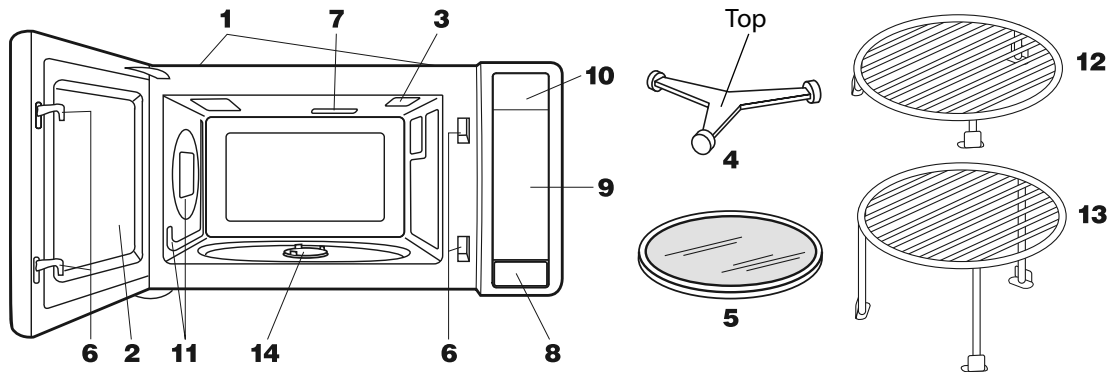

- 1 Ventilation openings. (Rear side)
- 2 Oven door with see-through window
- 3 Oven light.
It will light when the door is opened or when oven is in operation.
- 4 Turntable support
- 5 Removable turntable
The turntable will rotate clockwise or counterclockwise.
- 6 Safety door latches
The oven will not operate unless the door is securely closed.

- 7 Waveguide cover:
DO NOT REMOVE.
- 8 Door open button
- 9 Auto-Touch control panel
- 10 Lighted digital display
- 11 Convection air openings
- 12 Removable low rack (Broiling rack)
- 13 Removable high rack (Baking rack)
- 14 Turntable motor shaft

ACCESSORIES

The following accessories are designed especially for use in this oven only for convection, mix or broil cooking. DO NOT USE FOR MICROWAVE ONLY COOKING. Do not substitute similar types of racks for these specially designed ones.

High rack (Baking rack)–for convection and low mix.

- This rack is placed on the turntable for two-level cooking, such as layer cakes, muffins, etc.

Low rack (Broiling rack)–for convection, broiling or high mix.

- Place on the turntable and use for roasting or broiling to allow juices to drain away from food.

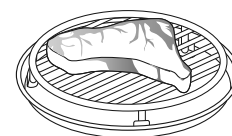
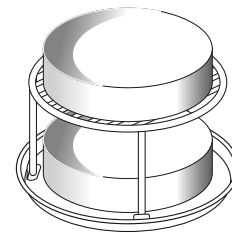

PART NAMES

CONTROL PANEL

Interactive Display

Words will light in the display to indicate features and cooking instructions.

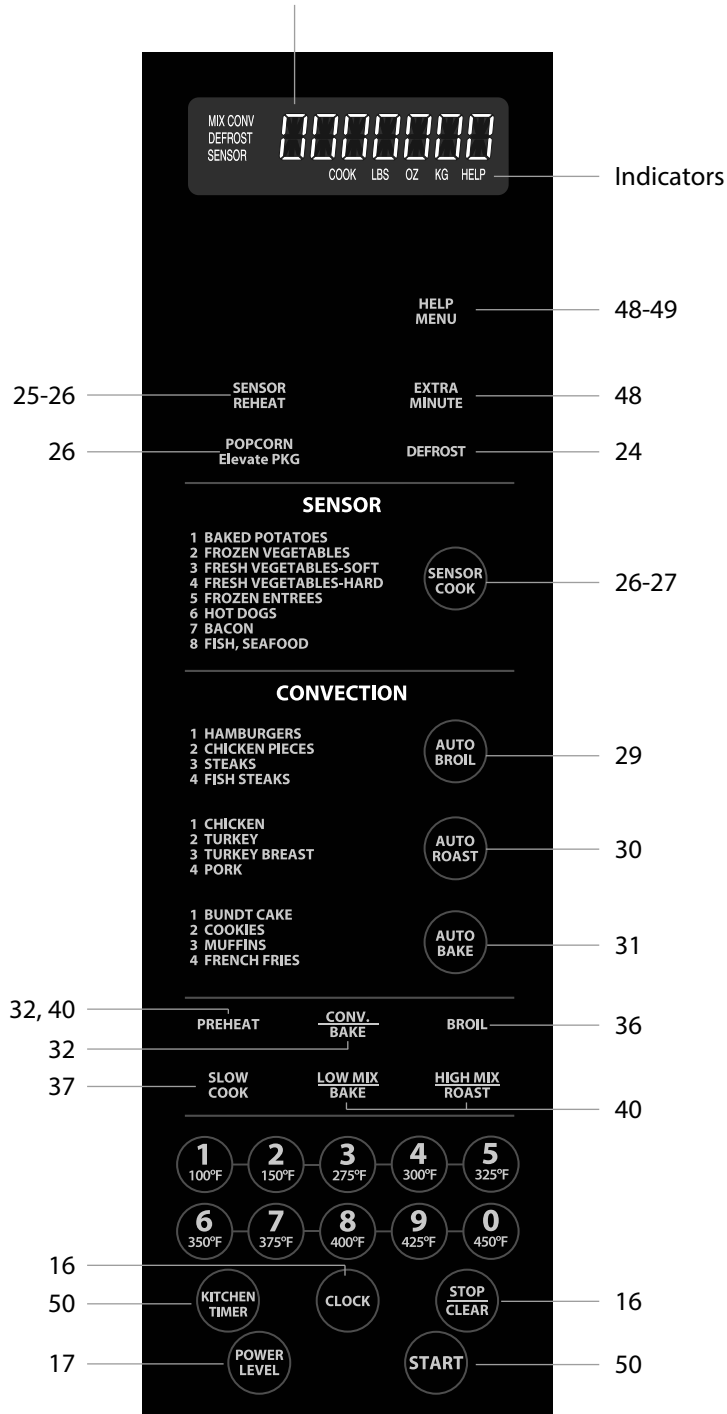

Number next to the control panel illustration indicates pages on which there are feature descriptions and usage information.

BEFORE OPERATING

- Before operating your new microwave oven make sure you read and understand this manual completely.
- Before the microwave oven can be used, follow these procedures:
 1. Plug in the microwave oven. Close the door. The microwave oven display will show WELCOME PRESS CLEAR AND PRESS CLOCK.
 2. Touch the STOP/CLEAR pad. : will appear.
 3. Set clock.

TO SET THE CLOCK

1. Touch CLOCK pad.
2. Enter the correct time of day by touching the numbers in sequence. Touch CLOCK pad again.

This is a 12 hour clock. If you attempt to enter an incorrect clock time, ERROR will appear in the display. Touch the STOP/CLEAR pad and re-enter the time.

- If the electrical power supply to your microwave oven should be interrupted, the display will intermittently show WELCOME PRESS CLEAR AND PRESS CLOCK after the power is reinstated. If this occurs during cooking, the program will be erased. The time of day will also be erased. Simply touch STOP/CLEAR pad and reset the clock for the correct time of day.

STOP/CLEAR

Touch the STOP/CLEAR pad to:

1. Erase a mistake you make during programming.
2. Cancel KITCHEN TIMER.
3. Stop the microwave oven temporarily during cooking.
4. Return the time of day to the display.
5. Cancel a program during cooking, touch twice.

MANUAL OPERATION

TIME COOKING

Your microwave oven can be programmed for 99 minutes and 99 seconds (99.99).

Always enter the seconds after the minutes, even if they are both zeros.

- Suppose you want to cook for 5 minutes at 100%.
 1. Enter cooking time by touching the number pads **5 0 0**.
 2. Touch START pad.

TO SET POWER LEVEL

There are eleven preset power levels.

Using lower power levels increases the cooking time which is recommended for foods such as cheese, milk and long slow cooking of meats. Consult cookbook or recipes for specific recommendations.

TOUCH POWER LEVEL PAD ONCE THEN TOUCH	APPROXIMATE PERCENTAGE OF POWER	COMMON WORDS FOR POWER LEVELS
POWER LEVEL	100%	High
9	90%	
8	80%	
7	70%	Medium High
6	60%	
5	50%	Medium
4	40%	
3	30%	Med. Low / Defrost
2	20%	
1	10%	Low
0	0%	

- Suppose you want to defrost for 5 minutes at 30%.
 1. Enter defrosting time by touching the number pads **5 0 0**.
 2. Touch POWER LEVEL pad and number **3**.
 3. Touch START pad.

You can program up to 4 automatic cooking sequences. Follow directions on page 48.

Note that Power Level must be entered first when programming multiple sequences.

MANUAL DEFROST

If the food that you wish to defrost is not listed on the DEFROST CHART or is above or below the limits in the 'Amount' column on the DEFROST CHART, you need to defrost manually.

You can defrost any frozen food, either raw or previously cooked, by using Power Level 3. Follow the exact 3-step procedure found under Time Cooking above. Estimate defrosting time and press 3 for 30% when you select the power level.

For either raw or previously cooked frozen food the rule of thumb is approximately 5 minutes per pound. For example, defrost 5 minutes for 1 pound of frozen spaghetti sauce.

Always stop the oven periodically to remove or separate the portions that are defrosted. If food is not defrosted at the end of the estimated defrosting time, program the oven in 1 minute increments on Power Level 3 until totally defrosted.

When using plastic containers from the freezer, defrost only long enough to remove from the plastic in order to place in a microwave-safe dish.

MICROWAVE FEATURES

MICROWAVE COOKING PRINCIPLES

The key to successful microwave cooking is understanding the basic conditions which may affect cooking results. The speed and evenness of microwave cooking are influenced by characteristics of the food itself and by differences in line voltage. House power varies throughout the country. Voltage fluctuates and is lower during periods of peak consumption.

Microwaves penetrate foods to a depth of about $\frac{3}{4}$ to $1\frac{1}{2}$ inches on all surfaces: top, bottom and sides. The interior of foods greater than 2 inches in diameter heats by conduction, as it does in conventional cooking. Foods with high water, fat or sugar content respond quickly to microwave energy.

Size – Small pieces cook faster than large ones. To speed cooking, cut pieces smaller than 2 inches so microwave can penetrate to the center from all sides. For even cooking, cut vegetables, fruit and meat into pieces of uniform size.

Quantity – Small amounts cook faster than large ones. Microwaving time is always directly related to the amount of food and increases with the quantity. When doubling a recipe, increase time by about one-half and check for doneness.

Starting temperature – Frozen or refrigerated food takes longer to heat than food at room temperature. Cooking times in this book are based on normal storage temperatures. Since rooms, refrigerators and freezers differ in temperature, check for doneness at the minimum time.

Fat and bone – Marbling within meat or a thin, even layer of fat on a roast attracts energy and speeds cooking. Drain excess drippings in dish during cooking to speed cooking. Bone conducts heat, so areas next to it may cook faster than other areas.

Shape – Foods which are irregular in shape, like fish fillets, chicken breasts or drumsticks, take longer to cook in the thicker parts. To help them cook evenly, place the thickest parts to the outside of the dish, where they will receive more energy.

Moisture content – Microwaves are readily attracted to moisture. Naturally moist foods microwave better than dry ones. Add a minimum of liquid to moist foods, as excess water slows cooking.

Density. Porous foods, such as ground beef or mashed potatoes, cook faster than dense foods, such as steak or whole potatoes, since microwaves penetrate them more easily. Turn dense foods over after one-half cooking time to speed and equalize cooking.

DEFROSTING FROZEN FOODS

Defrosting food with the microwave oven is not only faster than any other method, it can also give better results. Many microwave ovens are designed with a special automatic defrost setting which makes it safe, quick and easy to defrost meat and poultry.

Once frozen meat is defrosted, it begins to lose its juices. Microwave ovens give you the advantaged of letting you defrost meat just before you cook it for maximum juiciness and quality.

Microwave defrosting is easy, but some attention is needed to make sure that the ice crystals in frozen food melt without the food starting to cook. MEDIUM-LOW (30%) is fast enough to be convenient but gradual enough to give good results. At MEDIUM (50%) meat defrosts in about one-third less time but needs more attention.

Place plastic or paper-wrapped package of frozen food directly in oven. To speed defrosting, remove wrap as soon as possible and cover food with wax paper to hold in heat and prevent moisture loss. Foil wrappings must be removed.

Remove wrapping from turkey so you can feel warm spots as it defrosts. Metal clamps holding legs should be removed as soon as possible. Start breast side down, shield warm areas with small strips of foil and turn over after each one-fourth of time.

Let turkey stand 20 to 30 minutes submerged in cold water after defrosting, until giblets and neck can be removed and breast meat under wings is completely defrosted. Turkey may be microwaved with clamps if they are difficult to move.

MICROWAVE FEATURES

CONVENIENCE FOODS

How to Defrost Bagels and Muffins

Wrap frozen bagel or muffin in a paper towel or napkin. Microwave at MEDIUM (50%) until just warm to the touch (about 25 to 45 seconds for one, 40 seconds to 1 minute 20 seconds for two). Split bagels or muffins and toast, if desired.

How to Defrost Orange Juice or Lemonade Concentrate

Remove one metal lid from 6-ounce can of frozen juice. Place can upright in oven. Microwave at HIGH (100%) 30 seconds to 1 minute 30 seconds. Concentrate should be softened but not warm. Pour into container and stir in cold water as directed on can.

Most convenience foods now include microwave directions, making it easier than ever to enjoy soups, snacks, beverages, entrees and desserts. The package instructions are usually for HIGH (100%) for maximum speed and efficiency.

REHEATING

For freshest-tasting results, use power levels recommended in chart.

Pasta, rice and rolls. For leftover rice or pasta, drizzle with 1 tablespoon water per cup and reheat, covered. To reheat bread rolls or muffins, wrap in paper towel and microwave only until warm to the touch, not piping hot. Breads heat in seconds; overheating can cause breads to become tough, dry and hard.

Meats. Medium (1/4 inch) slices reheat best. Cover meat with sauce or gravy to protect from drying out. Meats with sauce should be covered with wax paper to hold in heat. Cover meat slices without gravy with paper towel.

REHEATING CHART

ITEM	STARTING TEMPERATURE	MICROWAVE TIME	PROCEDURE
Plate of Food 1 serving of meat, 2 servings of vegetables	Room temp. Refrigerated	MED.-HIGH (70%) 1-2 ¹ / ₂ min. 2 ¹ / ₂ -3 ¹ / ₂ min.	Meaty portions and bulky vegetables to outside. Cover with wax paper.
Meat (Chicken pieces, chops, hamburgers, meat loaf slices) 1 serving 2 servings	Refrigerated Refrigerated	MED.-HIGH (70%) 1-2 min. 2-4 min.	Cover loosely with wax paper.
Meat Slices (Beef, ham, pork, turkey) 1 or more servings	Room temp. Refrigerated	MEDIUM (50%) 1-1 ³ / ₄ min. per serving 1 ¹ / ₂ -2 ¹ / ₂ min. per serving	Cover with gravy or wax paper. Check after 30 sec. per serving.

MICROWAVE FEATURES

REHEATING CHART

ITEM	STARTING TEMPERATURE	MICROWAVE TIME	PROCEDURE
Stirrable Casseroles and Main Dishes 1 serving 2 servings 4-6 servings	Refrigerated Refrigerated Refrigerated	HIGH (100%) 1 ³ / ₄ -3 ¹ / ₂ min. 3 ¹ / ₄ -5 min. 6 ¹ / ₂ -7 ¹ / ₂ min.	Cover with glass lid. Stir after half the time.
Nonstirrable Casseroles and Main Dishes 1 serving 2 servings 4-6 servings	Refrigerated Refrigerated Refrigerated	MEDIUM (50%) 4 ¹ / ₂ -7 ¹ / ₂ min. 7 ¹ / ₂ -11 min. 12-15 min.	Cover with wax paper.
Soup, Cream 1 cup 1 can (10 ³ / ₄ oz)	Refrigerated Room temp.	MEDIUM (50%) 2 ³ / ₄ -5 ¹ / ₂ min. 5-7 ¹ / ₂ min.	Cover. Stir after half the time.
Soup, Clear 1 cup 1 can (10 ³ / ₄ oz)	Refrigerated Room temp.	HIGH (100%) 1 ³ / ₄ -3 min. 3 ¹ / ₂ -4 ¹ / ₂ min.	Cover. Stir after half the time.
Pizza 1 slice 1 slice 2 slices 2 slices	Room temp. Refrigerated Room temp. Refrigerated	HIGH (100%) 15-25 sec. 25-35 sec. 25-35 sec. 55-60 sec.	Place on paper towel on microwave-safe rack.
Vegetables 1 serving 2 servings	Refrigerated Refrigerated	HIGH (100%) ³ / ₄ -1 ¹ / ₄ min. 1 ¹ / ₂ -2 min.	Cover. Stir after half the time.
Baked Potato 1 2	Refrigerated Refrigerated	HIGH (100%) 1-2 ¹ / ₂ min. 2 ¹ / ₂ -3 min.	Cut potato lengthwise and then several times crosswise. Cover with wax paper.
Breads (Dinner or breakfast roll) 1 roll 2 rolls 4 rolls	Room temp. Room temp. Room temp.	HIGH (100%) 8-10 sec. 10-12 sec. 15-18 sec.	Wrap single roll, bagel or muffin in paper towel. To reheat several, line plate with paper towel; cover with another paper towel.
Pie 1 slice 2 slices	Refrigerated Refrigerated	HIGH (100%) 30-45 sec. 1-1 ¹ / ₂ min.	Place on microwave-safe dish. Do not cover.

After reheating, food should be very hot-165°F, if possible, stir food, cover and allow to stand two to three minutes before serving.

MICROWAVE FEATURES

VEGETABLE CHART

VEGETABLE	AMOUNT	COOKING PROCEDURE	MICROWAVE TIME AT HIGH (100%)	STANDING TIME, COVERED
Artichokes Fresh	2 medium	Trim and rinse. 2-qt casserole. 2 tbsp water. Cover with glass lid.	5-8 min.	5 min.
Asparagus Fresh Spears	1 lb	2-qt casserole. 2 tbsp water. Cover. Rearrange after 3 min.	4-7 min.	2 min.
Frozen Spears	10-oz. pkg.	1-qt. casserole. 1 tbsp. water. Cover. Rearrange after 3 min.	7-9 min.	2 min.
Beans Fresh, Green and Wax	1 lb	1 ¹ / ₂ -in. pieces, 2-qt casserole. 1/4 cup water. Cover. Stir twice.	9-13 min.	2 min.
Frozen, Green	10-oz. pkg.	1-qt. casserole. 1 tbsp. water. Cover. Stir after 3 min.	5-7 min.	2 min.
Frozen, Lima	10-oz. pkg.	1-qt. casserole. 1 tbsp. water. Cover. Stir once.	6-9 min.	2 min.
Beets Fresh, Whole	5 medium	Wash. Leave 1 inch of tops. 2-qt casserole. 1/4 cup water. Cover. Stir every 5 min.	12-18 min.	3 min.
Broccoli Fresh, Spears	1 lb	Wash. 2-qt casserole. Add no water. Cover. Rearrange after 3 min. Uncover during stand.	6-8 min.	3 min. uncovered
Fresh, Pieces	1 lb	Wash. 2-qt casserole. Add no water. Cover. Stir after 3 min. Uncover during stand.	5-7 min.	2 min. uncovered
Frozen, Spears, Cuts, Chopped	10-oz. pkg.	1-qt. casserole. 2 tbsp. water. Cover. Stir after 3 min. Uncover during stand.	5-7 min.	2 min. uncovered
Brussel Sprouts Fresh	4 cups	2-qt casserole. 1/4 cup water. Cover. Stir after 2 min.	6-8 min.	3 min.
Frozen	10-oz. pkg.	1-qt. casserole. 2 tbsp. water. Cover. Stir after 3 min.	6-8 min.	3 min.
Cabbage Shredded	1 lb	2-qt casserole. 2 tbsp water. Cover. Stir, after 4 min.	8-12 min.	2 min.
Wedges	1 lb	2-qt casserole. 2 tbsp water. Cover. Rearrange after 5 min.	12-14 min.	3 min.

MICROWAVE FEATURES

VEGETABLE CHART

VEGETABLE	AMOUNT	COOKING PROCEDURE	MICROWAVE TIME AT HIGH (100%)	STANDING TIME, COVERED
Carrots				
Fresh, Slices	2 cups	1-qt casserole. 2 tbsp water. Cover. Stir after 3 min.	5-8 min.	3 min.
Frozen, Slices	2 cups	1-qt casserole. 1 tbsp water. Cover. Stir after 3 min.	5-7 min.	3 min.
Cauliflower				
Fresh, Flowerets	2 cups	1-qt casserole. 1 tbsp water. Cover. Stir after 2 min.	3-5 min.	2 min.
Fresh, Whole	1 ¹ / ₂ lb	Remove leaves and core center. 2-qt casserole. 2 tbsp water. Cover.	7-9 min.	3 min.
Frozen, Flowerets	10-oz. pkg.	1-qt casserole. 1 tbsp water. Cover. Stir after 3 min.	4-6 min.	2 min.
Corn				
Fresh, on Cob	2 ears	9-in pie plate. 2 tbsp water. Cover. Rearrange after 4 min.	6-9 min.	5 min.
	4 ears	2-qt oval or rectangular casserole. 1/4 cup water. Cover.	12-14 min.	5 min.
Frozen, on Cob	2 ears	9-in pie plate. 2 tbsp water. Cover. Rearrange after 4 min.	6-8 min.	5 min.
	4 ears	2-qt oval or rectangular casserole. 1/4 cup water. Cover.	10-12 min.	5 min.
Frozen, Whole Kernel	10-oz. pkg.	1-qt casserole. 1 tbsp water. Cover. Stir after 3 min.	4-6 min.	2 min.
Okra				
Fresh, Whole	3/4 lb	1 ¹ / ₂ -2-qt casserole. 1/4 cup water. Cover. Stir after 3 min.	8-10 min.	3 min.
Frozen, Whole or slices	10-oz. pkg.	1 ¹ / ₂ -2-qt casserole. 2 tbsp water. Cover. Stir after 3 min.	6-8 min.	3 min.
Peas, Black-Eyes	10-oz. pkg.	2-qt casserole. 1/4 cup water. Cover. Stir after 4 min.	8-10 min.	3 min.
Frozen				
Peas, Green				
Fresh	2 cups	1-qt casserole. 1/4 cup water. Cover. Stir after 3 min.	4-6 min.	3 min.
Frozen	10-oz. pkg.	1-qt casserole. 1 tbsp water. Cover. Stir after 3 min.	6-8 min.	3 min.

MICROWAVE FEATURES

VEGETABLE CHART

VEGETABLE	AMOUNT	COOKING PROCEDURE	MICROWAVE TIME AT HIGH (100%)	STANDING TIME, COVERED
Potatoes Baked	2 medium 4 medium	Prick; place on paper towels. Turn over, rearrange at 1/2 time. Let stand, foil wrapped.	7-9 min. 13-16 min.	5-10 min. 5-10 min.
Boiled	4 medium	Peel and quarter potatoes. 2-qt casserole. Cover. Stir after 5 min.	9-12 min.	3 min.
Spinach Fresh	1 lb	Wash and trim. Add no water. 3-qt casserole. Cover. Stir after 3 min.	5-7 min.	2 min.
Frozen, Leaf or Chopped	10-oz. pkg.	1-qt casserole. Add no water. Cover. Stir after 3 min.	6-8 min.	2 min.
Squash Fresh, Acorn	1 whole	Prick; place on paper towel. Turn over after 4 min.	7-10 min.	5 min.
Fresh, Sliced Zucchini	2 cups	1-qt casserole. Add no water. Cover. Stir after 2 min.	2-4 min.	1 min.
Frozen, Mashed	10-oz. pkg.	1-qt casserole. Add no water. Cover. Break apart and stir after 3 min.	6-8 min.	2 min.
Sweet Potatoes Baked	2 medium 4 medium	Prick; place on paper towels. Turn over, rearrange after 5 min.	5-9 min. 10-13 min.	5 min. 5 min.
Tomatoes Fresh	2 medium 4 medium	Halve tomatoes. Round dish. Cover. Rearrange once.	2-4 min. 5-8 min.	2 min. 2 min.
Canned Vegetables	15 to 16 oz	1-qt casserole. Drain all but 2 tbsp liquid. Stir once.	2-4 min.	2 min.

MICROWAVE FEATURES

DEFROST

Defrost automatically defrosts foods shown in the Defrost Chart.

- Suppose you want to defrost a 2.0 pound steak:

1. Touch DEFROST pad once.
2. Select desired food by touching DEFROST pad until the display shows the food name.
Example: Touch twice for steak.
3. Enter weight by touching the number pads **2 0**.
4. Touch START pad.

The oven will stop and directions will be displayed. Follow the indicated message.

5. After the 1st stage, open the door. Turn steak over and shield any warm portions.
Close the door. Touch START pad.
6. After the 2nd stage, open the door. Shield any warm portions. Close the door. Touch START pad.
7. After defrost cycle ends, cover and let stand as indicated in chart below.

Note:

1. If you attempt to enter more or less than the allowed amount as indicated in chart, an error message will appear in the display.
2. Defrost can be programmed with More or Less Time Adjustment. See page 48.
3. To defrost other foods or foods above or below the weights allowed on Defrost Chart see Manual Defrost on page 17.

DEFROST CHART

FOOD	AMOUNT	PROCEDURE
1. Ground meat	0.5-3.0 lb (0.3-1.3 kg)	Remove any thawed pieces after each stage. Let stand, covered, 5–10 minutes.
2. Steaks (Chops/Fish)	0.5-4.0 lb (0.3-1.8 kg)	After each stage of defrost cycle, rearrange and if there are warm or thawed portions, shield with small flat pieces of aluminum foil. Remove any meat or fish that is nearly defrosted. Let stand, covered, 10–20 minutes.
3. Chicken pieces	0.5-3.0 lb (0.3-1.3 kg)	After each stage of defrost cycle, if there are warm or thawed portions, rearrange or remove. Let stand, covered, 10–20 minutes.

Note:

Check foods when oven signals. After final stage, small sections may still be icy.

Let stand to continue thawing. Do not defrost until all ice crystals are thawed.

Shielding prevents cooking from occurring before the center of the food is defrosted.

Use small smooth strips of aluminum foil to cover edges and thinner sections of the food.

MICROWAVE FEATURES

SENSOR

The Sensor is a semi-conductor device that detects the vapor (moisture and humidity) emitted from food as it heats. The sensor adjusts the cooking times and power level for various foods and quantities.

Using SENSOR Settings:

1. After oven is plugged in, wait 2 minutes before using sensor settings.
2. Be sure the exterior of the cooking container and the interior of the oven are dry. Wipe off any moisture with a dry cloth or paper towel.
3. SENSOR REHEAT and POPCORN can only be entered within 1 minute after cooking, opening and closing the door or touching the STOP/CLEAR pad.
4. During the first part of sensor cooking, the food name will appear on the display. Do not open the oven door or touch STOP/CLEAR during this part of the cooking cycle. The measurement of vapor will be interrupted. If this occurs, an error message will appear. To continue cooking, touch the STOP/CLEAR pad and select cooking time and variable power.

When the sensor detects the vapor emitted from the food, remainder of cooking time will appear. Door may be opened when remaining cooking time appears on the display. At this time, you may stir or season food, as desired.

5. Check food for temperature after cooking. If additional time is needed, continue to cook with variable power and time.
6. If the sensor does not detect vapor properly when popping popcorn, the oven will turn off, and the correct time of day will be displayed. If the sensor does not detect vapor properly when using sensor reheat, ERROR will be displayed, and the oven will turn off.
7. Any SENSOR mode can be programmed with More or Less Time Adjustment. See page 48.
8. Each food has a cooking hint. Touch HELP MENU when the HELP indicator is lighted in the display.

Selecting Foods:

1. The sensor works with foods at normal storage temperature. For example, food for dinner plate reheat would be at refrigerator temperature and popcorn at room temperature.
2. Foods weighing less than 3 ounces should be reheated by time and variable power.

Covering Foods:

Some foods work best when covered. Use the cover recommended in the chart for these foods.

1. Casserole lid
2. Plastic wrap: Use plastic wrap recommended for microwave cooking. Cover dish loosely; allow approximately 1/2 inch to remain uncovered to allow steam to escape. Plastic wrap should not touch food.
3. Wax paper: Cover dish completely; fold excess wrap under dish to secure. If dish is wider than paper, overlap two pieces at least one inch to cover.

Be careful when removing any covering to allow steam to escape away from you.

SENSOR REHEAT

You can reheat many foods by touching just one pad. You don't need to calculate reheating time or power level.

- Suppose you want to heat prepared chili:

Touch SENSOR REHEAT pad.

When sensor detects the vapor emitted from the food, remainder of reheating time will appear.

MICROWAVE FEATURES

POPCORN

- Suppose you want to pop a 3.5 oz. bag of popcorn:

Touch POPCORN pad once.

This sensor setting works well with most brands of microwave popcorn. You may wish to try several and choose your favorite. Pop only one bag at a time. Unfold the bag and place in oven according to directions.

SENSOR CHART

FOOD	AMOUNT	PROCEDURE
SENSOR REHEAT Leftovers such as rice, potatoes, vegetables, casserole.	4-36 oz	Place in dish or casserole slightly larger than amount to reheated. Flatten, if possible. Cover with lid, plastic wrap or wax paper. Use covers such as plastic wrap or lids with larger quantities of more dense foods such as stews.
Soups	1-4 cups	After reheating, stir well, if possible. Foods should be very hot. If not, continue to heat with variable power and time. After stirring, recover and allow to stand 2 to 3 minutes.
Canned entrees and vegetables	4-36 oz	Use Less Time Adjustment by touching Power Level pad twice for small quantities of canned vegetables.
POPCORN	Only 1 package at a time	Use only popcorn packaged for microwave oven use. Try several brands to decide which you like best. Do not try to pop unpopped kernels. More/Less Time Adjustment can be used to provide adjustment needed for older popcorn or individual tastes.
	3.0-3.5 oz bag (Regular size)	Touch POPCORN pad once. This setting works well with most 3.0-3.5 oz bags of microwave popcorn.
	1.5-1.75 oz bag (Snack size)	Touch POPCORN pad twice within 2 seconds for snack size bags.

SENSOR COOK

- Suppose you want to cook a baked potato:

1. Touch SENSOR COOK pad.
2. Select desired sensor setting. Example: Touch number pad **1** to cook baked potatoes.
3. Touch START pad. When sensor detects the vapor emitted from the food, the remainder of cooking time will appear.

MICROWAVE FEATURES

SENSOR COOK CHART

FOOD	AMOUNT	PROCEDURE
1. BAKED POTATOES	1-8 medium	Pierce. Place on paper-towel-lined turntable. After cooking, remove from oven, wrap in aluminum foil and let stand 5 to 10 minutes.
2. FROZEN VEGETABLES	1-8 cups	Cover with lid or plastic wrap. After cooking, stir and let stand 3 minutes, covered.
3. FRESH VEGETABLES, SOFT		Wash and place in casserole. Add no water if vegetables have just been washed.
Broccoli	0.25-2 lb	Cover with lid for tender vegetables.
Brussel sprouts	0.25-2 lb	Use plastic wrap for tender-crisp vegetables.
Cabbage	0.25-2 lb	Stir before standing if possible.
Cauliflower (flowerets)	0.25-2 lb	After cooking, let stand, covered, 2-5 minutes.
Cauliflower (whole)	1 medium	
Spinach	0.25-1 lb	
Zucchini	0.25-2 lb	
Baked apples	2-4 medium	
4. FRESH VEGETABLES, HARD		Place in casserole. Add 1-4 tbsp. water. Cover with lid for tender vegetables. Use plastic wrap cover for tender-crisp vegetables.
Carrots, sliced	0.25-1.5 lb	Stir before standing, if possible.
Corn on cob	2-4 pcs.	After cooking, let stand, covered, 2-5 minutes.
Green beans	0.25-1.5 lb	
Winter squash, diced	0.25-1.5 lb	
halves	1-2	
5. Frozen entrees	6-17 oz	Use for frozen convenience foods. It will give satisfactory results for most brands. You may wish to try several and choose your favorite. Remove package from outer wrapping and follow package directions for covering. After cooking, let stand, covered, for 1 to 3 minutes.
6. Hot dogs	1-4 servings	Place hot dog in bun and wrap in paper towel or paper napkin.
7. Bacon	2-6 slices	Place bacon on paper plate, lined with paper towel. Bacon should not extend over the rim of plate. Cover with paper towel. Put another paper plate upside down on turntable. Place plate of bacon on top of overturned plate.
8. Fish, seafood	0.25-2.0 lb	Arrange in ring around shallow glass dish (roll fillet with edges underneath). Cover with plastic wrap. After cooking, let stand, covered, 3 minutes.

MICROWAVE FEATURES

SENSOR COOK RECIPES

Cranberry Fluff

Makes 6 to 8 servings

- 2 cups fresh cranberries
- 1 cup water
- $\frac{3}{4}$ cup sugar
- 1 carton (3 oz.) orange-flavored gelatin
- $\frac{1}{2}$ pint whipping cream, whipped OR
- 1 carton (8 oz.) non-dairy whipped topping

1. Combine cranberries, water and sugar in a 2-quart casserole dish. Cover with wax paper. Microwave using SENSOR REHEAT Less. Drain cranberries and reserve liquid.
2. Add enough hot water to reserved liquid to make 2 cups. Stir gelatin into hot liquid until it dissolves. Cover with wax paper. Microwave using SENSOR REHEAT Less.
3. Add berries and cool. Refrigerate until thickened. Fold whipped cream into cooled cranberry mixture. Spoon into serving dishes and garnish with extra whipped cream. Refrigerate until ready to serve.

Glazed Apple Slices

Makes 6 to 8 servings

- $\frac{1}{4}$ cup firmly-packed brown sugar
- 3 tablespoons butter or margarine
- 2 tablespoons apricot preserves
- $\frac{1}{2}$ teaspoon ground nutmeg
- $\frac{1}{4}$ teaspoon salt
- $\frac{1}{2}$ cup sugar
- $\frac{3}{4}$ cup orange juice
- 1 tablespoon cornstarch
- 4 baking apples (about 1 $\frac{1}{2}$ lbs), peeled and sliced into 8 pieces each
- 3 tablespoons chopped green pistachios

1. Combine brown sugar, butter and apricot preserves in a small bowl. Microwave at HIGH (100%) 45 seconds to 1 minute, until butter melts and preserves soften. Stir in nutmeg, salt, sugar, orange juice and cornstarch. Microwave at HIGH (100%), 4 to 6 minutes or until thickened, stirring several times.
2. Arrange apple slices in a large microwave serving dish. Spread hot sauce over apples. Cover well with vented wax paper. Microwave using FRESH VEGETABLES-SOFT. Allow to cool 5 minutes before serving.
3. Sprinkle with pistachios. Serve alone or over vanilla ice cream or sponge cake.

Savory Flounder Fillets

Makes 4 servings

- $\frac{3}{4}$ cup corn flake crumbs
- 3 tablespoons chopped parsley
- 2 teaspoons grated lemon peel
- $\frac{1}{2}$ teaspoon paprika
- 1 pkg. (1 lb.) flounder fillets
- 1 egg, slightly beaten
- Tarter or cocktail sauce, optional

1. On wax paper, combine crumbs, parsley, lemon peel and paprika. Dip fillets in beaten egg, then coat with crumb mixture.
2. Place fish in a covered, microwave-safe baking dish. Microwave using FISH, SEAFOOD.
3. Serve with tartar or cocktail sauce, if desired.

CONVECTION AUTOMATIC OPERATION

This section of the operation manual offers instructions for preparing 12 popular foods using AUTO BROIL, AUTO ROAST and AUTO BAKE.

After selecting the desired feature, follow the directions indicated in the display.

For helpful hints, simply touch HELP MENU anytime HELP is lighted in the display.

Caution: The oven cabinet, cavity, door, turntable, turntable support, racks and dishes will become hot. To PREVENT BURNS, use thick oven gloves when removing the food or turntable from the oven.

AUTO BROIL

AUTO BROIL automatically broils hamburgers, chicken pieces, steaks and fish steaks.

- Suppose you want to broil 2 hamburgers:
 1. Touch AUTO BROIL pad.
 2. Select desired setting. Example: for hamburgers, touch number pad **1**.
 3. Touch number pad to enter quantity. Example: **2**. Follow information in display for cooking information.

For well done or rare burgers, touch POWER LEVEL pad to select More for well done or Less for rare. See More/Less Time Adjustment on page 48.

4. Touch START pad.

After broil preheat cycle ends, the oven will stop and directions will be displayed. Follow the indicated message. Open the door and place hamburgers into oven. Close the door.

5. Touch START pad.

Note:

1. *AUTO BROIL can be programmed with More/Less Time Adjustment. See page48.*
2. *If you attempt to enter more or less than the allowed amount as indicated in chart below, an error message will appear in the display.*
3. *To broil other foods or foods above or below the weight or number allowed on AUTO BROIL Chart, see Convection Broiling Chart.*

AUTO BROIL CHART

SETTING/FOOD	AMOUNT	RACK	PROCEDURE
1. HAMBURGERS	1-8 pieces 0.25 lb each	Low	Use this setting to broil hamburger patties. Place on low rack.
2. CHICKEN PIECES	0.5-3.5 lb	Low	Arrange pieces on low rack. After cooking, let stand, 3-5 minutes. Dark meat should be 180°F, and white meat should be 170°F.
3. STEAKS	0.5-2.0 lb	Low	Use this setting to broil steaks from 3/4" to 1" thick. Individual boneless steaks broil evenly. Place steak on low rack. For well done, touch POWER LEVEL once; for rare, touch POWER LEVEL twice.
4. FISH STEAKS	0.5-2.0 lb	Low	Use this setting to broil fish steak which is 3/4" to 1" thick. Place on low rack.

CONVECTION AUTOMATIC OPERATION

AUTO ROAST

AUTO ROAST automatically roasts chicken, turkey, turkey breast or pork.

- Suppose you want to roast a 2.5 pound chicken:
 1. Touch AUTO ROAST pad.
 2. Select desired setting. Example: For chicken, touch number pad **1**.
 3. Touch number pad to enter weight. Example: **2** **5** lb.
 4. Touch START pad.

After AUTO ROAST cycle ends, a long tone will sound. Follow the indicated message.

Note:

1. *AUTO ROAST can be programmed with More/Less Time Adjustment. See page 48.*
2. *If you attempt to enter more or less than the allowed weight as indicated in chart below, an error message will appear in the display.*
3. *To roast other food or foods above or below the weights allowed on AUTO ROAST Chart, check Combination Roasting Chart.*

AUTO ROAST CHART

SETTING/FOOD	AMOUNT	RACK	PROCEDURE
1. CHICKEN	2.5-7.5 lb	Low	After the cycle ends, cover with foil and let stand for 5-10 minutes.
2. TURKEY	6.5-16.0 lb	Low	Season, as desired. Place on low rack. After the cycle ends, cover with foil and let stand 10 minutes. Internal temperature of white meat should be 170°F and of dark meat, 180°F.
3. TURKEY BREAST	3.0-6.0 lb	Low	Season, as desired. Place on low rack. After the cycle ends, cover with foil and let stand 10 minutes. Internal temperature of white meat should be 170°F.
4. PORK	2.0-3.5 lb	Low	Boneless pork loin is recommended because it cooks evenly. Place on a low rack. After cooking, remove from oven, cover with foil and allow to stand 5-10 minutes. Internal temperature should be 160°F.

CONVECTION AUTOMATIC OPERATION

AUTO BAKE

AUTO BAKE automatically bakes cakes, brownies, muffins and French fries.

- Suppose you want to bake a bundt cake:
 1. Touch AUTO BAKE pad.
 2. Select desired setting. Example: For bundt cake, touch number pad **1**.
 3. Touch START pad.

Note:

1. AUTO BAKE can be programmed with More/Less Time Adjustment. See page 48.
2. To bake other foods, see baking chart.

AUTO BAKE CHART

SETTING/FOOD	AMOUNT	RACK	PROCEDURE
1. BUNDT CAKE	1 cake	No rack	Ideal for packaged cake mix or your own recipe. Prepare according to package or recipe directions and place in a greased and floured bundt pan. Place pan in oven. Cool before frosting and serving.
2. COOKIES	1 or 2 pizza pans	1 pizza pan No rack 2 pizza pans High	Ideal for refrigerated cookie dough. Prepare according to package or recipe directions and place on a greased and floured 12" pizza pan. Cookies should be approximately 1/3 inch thick and 2 inches in diameter for best results. After the preheat is over, place pan in oven. Cool before serving.
3. MUFFINS	6-12 cups 1 or 2 muffin pan	1 pan No rack 2 pans High	Ideal for packaged muffin mix or your own recipe for 6-12 medium size muffins. Prepare according to package or recipe directions and place in muffin pan. After the preheat is over, place pan in oven.
4. FRENCH FRIES	3-24 oz 1 or 2 pizza pans For more than 12 oz use 2 pans	1 pizza pan No rack 2 pizza pans High	Use frozen prepared French fries. No preheat is required for the French fries baking procedure. Place French fries on pizza pan. For shoestring potatoes, touch POWER LEVEL pad twice to enter less time before touching START pad.

MANUAL CONVECTION AND AUTOMATIC MIX COOKING

This section gives you specific cooking instructions and procedures. The oven should not be used without the turntable in place, and it should never be restricted so that it cannot rotate. You may remove the turntable when preheating the oven and when preparing food to be cooked directly on the turntable.

Caution: The oven cabinet, cavity, door, turntable, turntable support, racks and dishes will become hot. To PREVENT BURNS, use thick oven gloves when removing the food or turntable from the oven.

CONVECTION COOKING

During convection heating, hot air is circulated throughout the oven cavity to brown and crisp foods quickly and evenly. This oven can be programmed for ten different convection cooking temperatures for up to 99 minutes, 99 seconds.

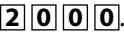

To Cook with Convection

- Suppose you want to cook at 350°F for 20 minutes:
 1. Touch CONV./BAKE pad.
 2. Select temperature by touching number pad .
 3. Enter cooking time by touching number pads .
 4. Touch START pad.

Note: If you wish to know the programmed oven temperature, simply touch the CONV./BAKE pad. As long as your finger is touching the CONV./BAKE pad, the programmed oven temperature will be displayed.

To Preheat and Cook with Convection

Your oven can be programmed to combine preheating and convection cooking operations. You can preheat to the same temperature as the convection temperature or change to a higher or lower temperature.

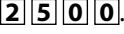
- Suppose you want to preheat to 350°F, and then cook 25 minutes at 375°F convection:
 1. Touch PREHEAT pad.
 2. Select temperature by touching number pad .
 3. Touch CONV./BAKE pad.
 4. Select temperature by touching number pad .
 5. Enter cooking time by touching number pads .
 6. Touch START pad.

When the oven reaches the programmed temperature, a signal will sound 4 times*. The oven will stop, and directions will be displayed. Follow the indicated message.

7. Open the door. Place food in the oven. Close the door. Touch START pad.

* If the oven door is not opened, the oven will automatically hold at the preheat temperature for 30 minutes. After this time has elapsed, an audible signal will sound, and the oven will turn off.

Note:

1. To program only preheat, touch the START pad after step 2. Preheating will start. When the oven reaches the programmed temperature, follow the indicated message.
2. To preheat and cook with the same temperature, enter same temperature in steps 2 and 4.

MANUAL CONVECTION AND AUTOMATIC MIX COOKING

Convection-Only Techniques

Convenience foods such as frozen appetizers, pizzas, egg rolls and refrigerated bread products bake and brown quickly with convection-only cooking. Follow package directions for conventional baking times.

Preheating the oven is necessary with convection cooking of smaller, faster-cooking food items that require less than 20 minutes of baking. Foods requiring longer baking time use LOW MIX.

Two-level baking allows baking of two pans of cookies, small muffins or pizzas at the same time. Round baking pans are excellent cooking utensils for many convection-only items.

Bread & Baking Techniques

Preheating of oven is not necessary. Bake one loaf 25 minutes and two loaves 30 minutes at LOW MIX. After baking, bread should be golden brown and sound hollow when tapped. Do not let bread stand in oven; remove from pans immediately to cool on wire rack.

Proofing dough. Use your own recipe or frozen dough. Place in well-greased bowl or loaf pan; cover with damp cloth. Place in oven at *SLOW COOK 100°F 30 to 45 minutes. Frozen dough will take longer, 2 to 2³/₄ hours. Dough is doubled when impressions remain after fingers are pressed 1/2 inch into dough. (*necessary to change temperature on SLOW COOK.)

Braid or other shape. Remove turntable from oven. Shape bread; lace directly on turntable. No preheating is needed. Bake for three-fourths of the time in your conventional recipe on LOW MIX.

Pie Techniques

Custard Pies. Prebake and cool pie shell as directed above. Fill with uncooked custard. Without preheating, bake pie on round baking pan placed on broiling rack for 30 to 35 minutes on *LOW MIX, 325°F. If custard is not set, let stand in oven a few minutes to complete cooking. (*Necessary to change temperature on LOW MIX).

Pie Shell. Use mix, frozen pie dough, or your recipe for single crust pie. Prick crust with fork. Preheat oven to 425°F. Place pie shell on broiling rack; bake with convection heat 8 to 10 minutes or until lightly browned. Cool and fill.

Frozen Prepared Custard-Type Pies. Preheat oven to temperature listed on package. Place pie on broiling rack. Bake three-fourths of package time using LOW MIX set at the package temperature. If filling is not set, let stand in oven to complete cooking. **Frozen Prepared Fruit Pies.** Do not preheat oven. Bake on broiling rack. Use *HIGH MIX, 375°F. Bake 8-inch, 35 minutes; 9-inch, 40 to 45 minutes. (*Necessary to change temperature on HIGH MIX).

Double Crust or Crumb Top Pies. Prepare pie as you would for conventional baking; make slits in top of two crust pie. Preheat oven to 400°F. Place pie on broiling rack. Bake double crust or lattice pies 25 to 35 minutes on *HIGH MIX, 400°F; crumb top pies 20 to 25 minutes on *HIGH MIX, 400°F (*Necessary to change temperature on HIGH MIX).

Convection Baking Chart

ITEM (For foods requiring 25 minutes or less)	BAKING TIME AND TEMPERATURE
Appetizers: Brown and serve, pastry	Follow package directions.
Biscuits: Your recipe, mix or refrigerator	Follow recipe or package directions.
Cookies: Drop, rolled, refrigerator, spritz, molded	Follow recipe or package directions.
Fish Sticks: Frozen	Follow package directions.
Layer Cakes: Your recipe or mix	Follow recipe or package directions.
Muffins: Your recipe or mix	Follow recipe or package directions.
Pizza: Your recipe or frozen	Follow recipe or package directions.
Puff Pastry: Your recipe or frozen	Follow recipe or package directions.
Rolls: Your recipe, package or refrigerator	Follow recipe or package directions.

MANUAL CONVECTION AND AUTOMATIC MIX COOKING

Cake Techniques

Layer Cakes. Use a mix or your own conventional recipe. Follow recipe or package directions for preheating and baking instructions. Use baking rack and turntable to bake two layers at once, in AUTO BAKE.

Tube or Bundt Cakes. Do not preheat oven. Bake cakes for three-fourths of time on recipe or package directions using LOW MIX. Bake cake on broiling rack. If arcing occurs with fluted tube pan, place a heat-and-microwave-safe dish or plate between pan and broiling rack.

Angel Food. Do not preheat oven. Bake your recipe or a mix 25 to 30 minutes on LOW MIX or until crust is golden brown, firm and looks very dry in Angel Food Cake pan.

Loaf Cakes or Quick Breads. Do not preheat oven. Bake for three-fourths of time on recipe or package directions using LOW MIX. Test for doneness at minimum time. If loaf is not done, let stand in oven a few minutes to complete cooking.

Combination Baking Chart

FOOD	PROCEDURE
<p>Cakes: Your recipe or mix</p> <ul style="list-style-type: none"> • Tube or Bundt Cakes** • Angel Food • Loaf Cakes or Quick Breads 	<ul style="list-style-type: none"> • Bake on broiling rack three-fourths the recommended time on LOW MIX. • Bake 25 to 30 minutes on LOW MIX. • Bake three-fourths the recommended time on LOW MIX.
<p>Bar Cookies: Your recipe or mix</p>	<ul style="list-style-type: none"> • Bake three-fourths the recommended time or until wooden pick inserted in center comes out clean on LOW MIX.
<p>Pies</p> <ul style="list-style-type: none"> • Single Crust: baked before filling, your recipe, mix or frozen prepared • Double Crust • Crumb Top • Custard Pie • Pecan Pie • Frozen Prepared Fruit Pies • Frozen Prepared Custard Pies 	<ul style="list-style-type: none"> • Prick crust with fork. Preheat oven to 425°F. Bake on broiling rack 8 to 10 minutes or until lightly browned. Let cool before filling. • Preheat oven to 400°F. Bake on broiling rack 25 to 35 minutes on *HIGH MIX 400°F. • Preheat oven to 400°F. Bake on broiling rack 20 to 25 minutes on *HIGH MIX 400°F. • Prebake, following directions for single crust; cool. Fill with desired uncooked custard. Bake on round baking pan on broiling rack 35 minutes on *LOW MIX 325°F. If custard is not set, let stand in oven a few minutes. • Preheat oven to 350°F. Bake on broiling rack 25 to 30 minutes on LOW MIX. • Place on broiling rack and bake 30 to 40 minutes using *HIGH MIX 375°F. • Preheat oven to package temperature. Place on broiling rack and bake three-fourths of package time using LOW MIX and package temperature. If not set, let stand in oven a few minutes.

MANUAL CONVECTION AND AUTOMATIC MIX COOKING

Combination Baking Chart

FOOD	PROCEDURE
Breads <ul style="list-style-type: none"> Loaf: Your recipe or frozen, defrosted and proofed Braid or other shape Muffins: Large, bakery-style 	<ul style="list-style-type: none"> Bake 25 to 30 minutes on LOW MIX for 1 to 2 loaves. Remove turntable from oven. Place bread directly on turntable. Bake on LOW MIX three-fourths the recommended time. Bake three-fourths the recommended package or recipe time on LOW MIX.
Desserts <ul style="list-style-type: none"> Cheesecake Crisps and Cobblers 	<ul style="list-style-type: none"> Bake three-fourths the recipe time on LOW MIX or until center is nearly set. Bake three-fourths the recipe time on LOW MIX.
<p>** If arcing occurs while using a fluted tube pan, place a heat-resistant dish (Pyrex® pie plate, glass pizza tray or dinner plate) between the pan and the broiling rack.</p> <p>* Necessary to change temperature on HIGH MIX and LOW MIX.</p>	

Upside Down Spice Pear Cake

Makes 12 servings

Convection, Turntable and High Rack

A fast elegant dessert.

- 1 Spice cake mix, one package
- 2 pears, cored, sliced into 12 slices each
- 1 cup brown sugar, packed
- 1 cube butter, melted
- 8 Maraschino Cherries, sliced in half

1. Prepare spice cake mix as directed on package.
2. Prepare two 9-inch cake pans, divide melted butter and brown sugar into pans, and spread it evenly on bottom.
3. After peeling pears, cut in half and core seeds and remove stem. Place cut side down and cut from small end to large end, 1/4 inch thick. Place slice pears in pan with larger end of pear near pan edge, go in a circle around pan.
4. Put 3 Maraschino Cherries halves in center with the rounded part of the cherry on bottom of each pan. Cut the other cherries into 1/8th. Place between each pear slice.
5. Divide batter between the two 9 inch cake pans.
6. Place **high rack** on **turntable**; place both the 9 inch cake pans in center of each turntable and rack. Close door.
7. Press PREHEAT, temperature 6
350°F, CONV. and temperature 6
350°F and then press time 4 5 0 0 minutes. Check cake at 40 minutes, if not done continue 5 more minutes on program.
8. Cool for 5 minutes on cooling rack.
9. Invert on serving platter, you'll have two elegant Pear Cakes. Top off with whipping cream or vanilla ice cream if you wish. Surprise your family and guest with your creativity.

MANUAL CONVECTION AND AUTOMATIC MIX COOKING

Fiesta Cheese Strata

Makes 6 servings

Convection – Low Rack

- 1 cup milk
- 1 cup (4 oz.) shredded sharp cheddar cheese
- 1/4 cup (1 oz.) grated parmesan cheese
- 1/4 teaspoon dry mustard
- 1/2 teaspoon salt
- Dash of cayenne pepper
- 3 egg yolks
- 2 cups bread, soft, cubed
- 1 teaspoon oil
- 1/2 cup onion, chopped, sauté
- 1/2 cup red pepper, sauté
- 1/2 cup green pepper, sauté
- 4 oz. mushrooms
- 3 egg whites, stiffly beaten, but not dry
- 1 large tomato, 6 slices

Pre-heat 325°F CONVECTION

1. Scald milk. Add cheddar cheese, parmesan cheese, mustard, salt and cayenne pepper. Stir to partially melt cheese. Add bread cubes; stir in egg yolks.
2. Sauté green, red pepper, onions and mushrooms in skillet with hot oil.
3. Beat egg whites until stiff. Fold-in beaten egg whites into cheese mixture until it is one color.
4. Spray with vegetable oil, 9-inch cake pan. Spread Strata mixture evenly in baking dish, place sliced tomatoes on top, around edge.
5. Press CONV., touch **5**_{325°F} and enter max time of 40 minutes. Check at 35 minutes, if not done, close door and finish the 40 minute program. A silver knife should come clean when inserted in center of Strata.
6. Serve Hot.

For variety, you can add bacon, chicken, ham, and a variety of vegetables, like peas, broccoli, and asparagus, great for brunch.

BROIL

Preheating is automatic when the BROIL setting is used. Only actual cooking time is entered; the oven signals when it is preheated to 450°F. Oven temperature cannot be changed. Use BROIL setting for steaks, chops, chicken pieces and many other foods. See Convection Broiling Chart.

- Suppose you want to broil a steak for 15 minutes:

1. Touch BROIL pad.
2. Enter cooking time by touching the number pads **1 5 0 0**.
3. Touch START pad. No food in oven.

When the oven reaches the programmed temperature, a signal will sound 4 times*.

4. Open the door. Place food in oven. Close the door. Touch START pad.

* If the oven door is not opened, the oven will automatically hold at the preheat temperature for 30 minutes. After this time has elapsed, an audible signal will sound and the oven will turn off.

MANUAL CONVECTION AND AUTOMATIC MIX COOKING

Note:

1. Preheating for broil may take from 7 to 10 minutes depending on temperature of room and available power.
2. Although time is usually set for the maximum broiling time, always check food at the minimum time recommended in the chart. This will eliminate the need to completely reprogram the oven if additional cooking time is needed. Simply close the oven door and touch START to continue.
3. Should you need more broiling time, reprogram within 1 minute of the end to eliminate preheating.

Caution: The oven cabinet, cavity, door, turntable, turntable support, racks and dishes will become hot. To PREVENT BURNS, use thick oven gloves when removing the food or turntable from the oven.

SLOW COOK

SLOW COOK is preset at 300°F for 4 hours. The temperature can be changed to below 300°F. The cooking time cannot be changed. This feature can be used for foods such as baked beans or marinated chuck steak.

- Suppose you want to change oven temperature from 300°F to 275°F:

1. Touch SLOW COOK pad.
2. Touch SLOW COOK pad once more if you want to change the temperature from 300°F.
3. Touch temperature pad 3
275°F.
4. Touch START pad.

Note: If you do not change the temperature, omit steps 2 and 3.

Convection Broiling Chart

CUT	WEIGHT/THICKNESS	CONVECTION TIME
Beef		Rare : 10-13 min.
Rib-eye Steak	3/4-1 in. 7-8 oz. each	Medium : 14-16 min. Well Done : 17-20 min.
Steaks: Sirloin, Porterhouse, T-bone Rib-eye Steak	1-1 1/2 in. 7-8 oz. each	Rare : 10-13 min. Medium : 14-18 min. Well Done : 19-25 min.
Chuck, Steak	1 in.	Rare : 12-14 min. Medium : 15-18 min. Well Done : 19-23 min.
London Broil min.	1-1 1/4 in. 2 1/2-3 lbs.	Rare : 23-25 min. Medium : 26-30
Hamburgers	1/4 lb. each	Medium : 13-15 min. Well Done : 18-20 min.

MANUAL CONVECTION AND AUTOMATIC MIX COOKING

Convection Broiling Chart

CUT	WEIGHT/THICKNESS	CONVECTION TIME
Pork		
Rib-eye Steak	3/4-1 in.	Well Done : 16-20 min.
Bacon	Regular sliced Thick sliced	4-5 min. 7-8 min.
Sausage: Brown 'n Serve Fresh	Patties: 1/2 in., 8 oz.-1 lb. Links: 8 oz. - 1 lb.	8-10 min. 8-10 min.
Ham, slice, fully cooked	3/4 in.	10-12 min.
Frankfurters	1 lb.	5-7 min.
Lamb		
Chops: rib, loin or center	3/4 in. 3-4 oz. each	Medium : 12-14 min. Well Done : 15-17 min.
Chicken		
Broiler-Fryer, halved, quartered or cut up	1-3 lbs.	25-35 min.
Fish		
Fillets	1/4-3/4 in.	6-7 min.
Steaks	3/4 in.	12-14 min.

Check chart above for maximum broiling time. Program oven for maximum time on BROIL or 450°F, following BROIL directions. Season and slash fat at 1-inch intervals. When audible signal sounds that oven is preheated, quickly put food in oven.

Spray rack and turntable with nonstick vegetable cooking spray for easy cleanup. Do not cover rack with aluminum foil, as it blocks the flow of warm air that cooks the food.

Cook for the minimum time recommended in the chart; then test for doneness. Time varies with the thickness or weight of meat and degree of desired doneness. Turning meat over is not necessary, as moving air cooks it on both sides.

Broil food in advance, if desired, then slice. Individual servings may be reheated as needed by microwaving at MEDIUM (50%).

Hawaiian Stuffed Mushrooms

Appetizers - 20+ serving

Broil

- 1 lb. mushrooms, fresh, medium to large in size
- 8 oz. cream cheese, soft
- 4 oz. Bay Shrimp or crab
- 8 oz. pineapple, crushed, drained
- 1/4 teaspoon garlic salt
- 2 tablespoons chives, chopped fine

MANUAL CONVECTION AND AUTOMATIC MIX COOKING

- 1/4 teaspoon garlic salt
- 1/4 teaspoon red pepper flakes
- 1 tablespoon olive oil
- 1/2 cup bread crumb, dried

1. Wash, dry, and remove stems from mushrooms, save stems for soup or a stew. If using bay shrimp, save out as many as you have mushrooms, put aside for topping.
2. Mix together cream cheese, shrimp or crab, crushed pineapple, chives, 1/4 teaspoon garlic salt and red pepper.
3. Add olive oil, garlic salt to breadcrumbs, and toss together, until coated.
4. Preheat Microwave convection for 5 minutes. Press BROIL, set time for 5-7 minutes, then press START.
5. Spoon the cream cheese mixture into the mushroom cap. Dip mushroom cap into bread crumbs. Place tiny shrimp on top, push down into cheese and bread crumb mixture.
6. Place on a low rack. Place low rack on turntable, press BROIL, set time for 5 minutes. Add more time if they are not hot enough.
7. Serve hot as a great appetizer

Teriyaki Sesame Chicken Wings

Appetizers - 20+ serving

Broil – Low Rack

- 2 1/2 lbs. chicken wings
- 1/2 cup soy sauce
- 1/2 cup sherry wine
- 1 tablespoon sesame oil
- 1/4 teaspoon black pepper
- 1/2 teaspoon cayenne pepper
- 1 teaspoon liquid hickory smoke
- 1/2 cup brown sugar
- 2 tablespoons cornstarch
- 2 tablespoons sesame seeds

1. Cut off chicken wing tips, discard, cut drummet at joint, wash.
2. In a 2 cup microwavable glass measure, add soy sauce, sherry wine, sesame seed oil, black pepper, cayenne pepper and liquid hickory smoke.
3. Mix brown sugar and cornstarch together, until it looks like one color, in a large bowl. Add to liquid. Microwave on high for 3 to 5 minutes, until it starts to thicken, stir every minute.
4. Add chicken to large bowl and pour hot liquid over chicken and marinate for 1 to 2 hours, stirring occasionally, cover.
5. Use low rack, spray with a vegetable oil. Place chicken wings on low rack. Sprinkle 1 tablespoon sesame seeds over chicken wings. Broil for 35 minutes on BROIL. Press BROIL, then press **3 5 0 0** minutes, press START. It should be a rich golden brown color. No need to turn wings, they will brown on both sides.

Serve warm as a finger food and plenty of napkins, a tasty delight.

MANUAL CONVECTION AND AUTOMATIC MIX COOKING

AUTOMATIC MIX COOKING

This oven has two pre-programmed settings that make it easy to cook with both convection heat and microwave automatically.

	Oven temperature	Microwave power
High mix/Roast	300°F	30%
Low mix/Bake	350°F	10%

With the exception of those foods that cook best by convection heating alone, most foods are well suited to mix cooking using either LOW MIX/BAKE or HIGH MIX/ROAST.

The marriage of these two cooking methods produces juicy meats, moist and tender cakes and fine textured breads, all with just the right amount of browning and crispness.

The temperatures can be changed; however, the microwave power cannot.

The oven temperature can be changed from 100°F to 450°F To change the temperature, first touch HIGH MIX or LOW MIX then touch the same pad again. When the display says SELECT TEMP, touch desired temperature pad. Example: High mix, HIGH MIX pad, **7**. The mix temperature will change to 375°F automatically.

To Cook with Automatic Mix

- Suppose you want to bake a cake for 25 minutes on LOW MIX/BAKE:
 1. Touch LOW MIX/BAKE pad.
 2. Enter cooking time by touching number pads **2 5 0 0**.
 3. Touch START pad.

To Preheat and Cook with Automatic Mix

Your oven can be programmed to combine preheating and automatic mix cooking operations. You can preheat at the same temperature as the preset combination temperature or change it to a different temperature.

- Suppose you want to preheat to 350°F and then cook 25 minutes on 325°F LOW MIX/BAKE:
 1. Touch PREHEAT pad.
 2. Touch temperature pad **6** 350°F.
 3. Touch LOW MIX pad.
 4. Touch LOW MIX pad once more to change the cooking temperature.
 5. Touch temperature pad **5** 325°F.
 6. Enter cooking time by touching number pads **2 5 0 0**.
 7. Touch START pad.

When the oven reaches the programmed temperature, signal will sound 4 times*. The oven will stop and directions will be displayed. Follow the indicated message.

8. Open the door. Place food in the oven. Close the door. Touch START pad.

* If the oven door is not opened, the oven will automatically hold at the preheat temperature for 30 minutes. After this time has elapsed, an audible signal will sound and the oven will turn off.

Note: To program only preheat, touch the START pad after step 2. Preheating will start. When the oven reaches the programmed temperature, follow the indicated message.

MANUAL CONVECTION AND AUTOMATIC MIX COOKING

Helpful Hints for Convection and Automatic Mix Cooking

Your Convection Microwave Oven can cook any food perfectly because of the number of ways it can cook: microwave only, automatic mix, convection only or broil. This manual tells you how to program the oven, with excellent instructions, guidelines, hints, charts and recipes.

The oven cannot be used without the turntable in place. Never restrict the movement of the turntable.

Convection Cooking:

1. When preheating, the turntable can be left in or removed. When using the high rack for 2 shelf baking in a preheated oven, it is easier to remove the turntable for preheat.

Place high rack on turntable along with foods. When preheat is over, open oven door and quickly place turntable, high rack and foods to be baked inside.
2. Do not cover turntable, low rack or high rack with aluminum foil. It interferes with air flow that cooks food.
3. Round pizza pans are excellent cooking utensils for many convection-only items. Choose pans that do not have extended handles, 10", 12" and 14" size.
4. Using a preheated low rack can give a grilled appearance to steaks, hot dogs etc.

Automatic Mix Cooking:

1. Meats are best when roasted directly on the low rack. A dish can be placed below the meat if gravy is to be made from the drippings.
2. Less tender cuts of meat can be roasted and tenderized using oven cooking bags.
3. When baking, check for doneness after time has elapsed. If not completely done, let stand in oven a few minutes to complete cooking.

Note: During mix baking some metal baking utensils may cause arcing when they come in contact with the oven walls or accessory racks. Arcing is a discharge of electricity that occurs when microwaves come in contact with metal.

If arcing occurs, place a heat resistant dish (Pyrex® pie plate, glass pizza dish or dinner plate) between the pan and the rack. If arcing occurs with other metal baking utensils, discontinue their use for mix cooking.

MANUAL CONVECTION AND AUTOMATIC MIX COOKING

Breakfast Smoked Sausage Pizza

Makes 6-8 servings

Low Mix – Low Rack

Crust

- 3 cups biscuit mix
- $\frac{3}{4}$ cup milk
- 1 egg

Filling

- 4 eggs
- 1 lb. cooked smoked sausage cut in slices $\frac{1}{2}$ inch thick.
- 8 oz. cream cheese, soften
- 1 cup cheddar cheese, shredded
- 2 green onions, slice fine
- $\frac{1}{8}$ teaspoon salt and pepper

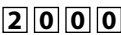
1. Mix all the crust ingredients together in medium bowl; knead dough on flour board about 10 to 12 times. Spray 14-inch pizza pan with vegetable oil.
2. Spread dough, using your hands or the back of wooden spoon to spread evenly in pizza pan, start to go up sides.
3. Touch PREHEAT pad, press , touch LOW MIX, enter time , and touch START pad. This will start the Preheat and your program for this dish.
4. In mixer, beat eggs with soften cream cheese, till smooth, add salt and pepper.
5. Place cut sausages $\frac{1}{2}$ inch from edge, press towards edge to make a lip around pizza and place the rest of the sausage evenly thru out the dough.
6. Pour egg mixture over pizza dough up to 1 inch from edge.
7. Sprinkle cheddar cheese and green onions over topping.
8. When the bell rings four times, the oven is preheated. Place pizza pan on low rack, then press START. It is programmed to stop at 20 minutes.

This recipe can be cut in half for fewer servings using the 7 or 9-inch pizza pan, serves four people. Change time to 15 minutes. Always check to see if the eggs are cooked. Serve with fresh fruit, you have a complete delicious meal.

MANUAL CONVECTION AND AUTOMATIC MIX COOKING

Apple Puff Oven Pancake

Makes 6 servings

Low Mix

- 2 tablespoons butter
- 3 large eggs
- 1/2 cup unbleached flour
- 1/2 cup milk
- 1/4 teaspoon salt

- 4 tart apples, large, peeled, cored, sliced thin
- 2 tablespoons butter
- 1/2 cup brown sugar
- 1/4 teaspoon nutmeg
- 1/2 teaspoon cinnamon
- Pinch of salt
- 1 teaspoon cornstarch
- 3 drops red food coloring

Preheat Oven on LOW MIX at 400°F.

- Prepare apples, melt butter in large skillet, and add thinly cut apples, sugar, cinnamon, nutmeg, salt, cornstarch and food coloring. Stir and cook till caramelized and limp. Cover and keep warm after cooking.
- Place butter in a 9 or 10 inch Pyrex pie plate. Place Pyrex dish in oven on low rack for 3 minutes on LOW MIX or until butter melts and bubbles, while oven is preheating.
- In a bowl, beat eggs, till creamy yellow. Add flour, milk, and salt. Beat till smooth. Immediately pour into the hot Pyrex pie pan over hot butter. Close door. Press LOW MIX twice; change temperature to 400°F, by pressing **8**_{400°F}, then press in **1 5 0 0** minutes for time. Press START, egg batter will gradually go up sides and turn golden brown around the edges. Pour hot apple mixture on top of cooked puff pancake, serve immediately while hot.

This is a great brunch idea or a wonderful quick dessert for a fall or winter day.

MANUAL CONVECTION AND AUTOMATIC MIX COOKING

Lemon Curd Tart

Makes 10-12 servings

Low Mix – Low Rack

With this dark sweet pastry as the shell of our tart, it brings out the brilliant yellow color and the tangy taste of the curd.

Dark Sweet Pastry Dough

- 1 large egg
 - 2 tablespoons heavy Cream
 - 1/2 teaspoon vanilla extract
 - 1 cup flour, unbleached, plus 1 tablespoon for dusting
 - 1/4 cup cornstarch
 - 2/3 cup powder sugar
 - 1/4 teaspoon salt
 - 8 tablespoons butter or 1 cube, very cold, cut into 14 pieces
- Parchment paper, 12 x 12 inches.

This sweet dark crust has lots of flavor that is brought out with the Low Mix baking.



1. In a small bowl, whisk egg yolk, cream and vanilla together.
2. Use your food processor with steel blade, process, flour, sugar, cornstarch and salt for 5 to 10 seconds.
3. Scatter butter pieces on top of flour mixture, pulse on and off for 15 to 20 seconds, till it looks like course meal.
4. While processor is 'on', add egg, cream pulse for about 20 to 25 seconds, till it comes together into a ball.
5. Turn dough out on a 14 inch piece of plastic wrap. Flatten dough to make a 6 inch circle, wrap tightly, refrigerate for 2 hours or freeze for 30 minutes.
6. Unwrap dough, sprinkle flour onto Parchment or wax paper. Place dough on top of parchment; roll out 1 inch larger than tart pan. Always roll from the center out, go a different direction on each roll.
7. Press PREHEAT, 6_{350 F}. Touch LOW MIX, and Touch 6_{350 F} enter time 1800, low rack position, press START.
8. Roll dough onto rolling pin, place over 2 piece tart pan. Unroll over tart pan.
9. Lift edges of dough, ease into tart bottom, and don't stretch dough.
10. Press dough into the fluted edges, it should be 1/4 inch thick around fluted edges. Add more dough around edge, if it's not thick enough.
11. With rolling pin, roll over top edge, remove the extra dough. Push dough into corners of tart pan.
12. Make two 12 x 6 inch strips of wax paper, fold to make 1 inch roll by 12 inches long. Place wax paper on inside edge seam to hold dough in place while baking or use weighted beads or beans along bottom seam.
13. Place in preheated oven, low rack, for 18:00 minutes. Pastry will look dark.
14. While crust is baking, prepare the Lemon Curd Filling for tart.

MANUAL CONVECTION AND AUTOMATIC MIX COOKING

Lemon Curd Tart Filling

Convection – Low Rack

- 1 9 to 10 inch baked dark sweet tart shell
- 7 eggs yolks, large
- 1 whole eggs, large
- 1¹/₂ cups powder sugar
- 1 tablespoon lemon zest
- ³/₄ cup lemon juice, fresh, (4 to 5)
- ¹/₂ cup water
- ¹/₄ teaspoon salt
- ¹/₄ cup cream

1. While tart crust is baking, make Lemon Curd filling.
2. Whisk together yolk and whole eggs in non-reactive medium size bowl for about 5 seconds.
3. Hint: Zest lemons first when they are still cold or at room temperature, using the yellow skin only, white is very bitter.
4. Before cutting lemons, rolls lemons with the palm of your hands on a hard surface, then place all the lemons in the microwave for 20 to 25 second, usually 5 to 10 seconds per lemon. You will get more juice from your lemons from this method.
5. Add sugar, lemon juice, zest and salt, whisk together.
6. Pour into medium sauce pan, cook over medium heat, stirring with a wooden spoon constantly. It should thicken and read a temperature 170°F on the instant read thermometer, about 5 minutes. Remove from range.
7. Pour curd through a wire sieve strainer, using a back of a wooden spoon to push the curd through the sieve, into a medium size bowl. It will be silky smooth.
8. Add cream, whisk till blended.
9. Pour Lemon Curd into warm tart pan, smooth out equally over crust tart.
10. Press CONVECTION. Touch , and press  for time. When done, center will jiggle a little. Take out of oven, place on cooling rack to cool for at least 45 minutes.
11. Remove outer fluted ring, and take a long metal spatula, slip it under the tart bottom and release from the bottom of tin, place on serving platter.
12. Cut when completely cool, garnish with fresh mint, fresh berries of the season.

The dark sweet crust enhances the appearance of the bright yellow curd, a wonderful combination, and a very refreshing taste.

MANUAL CONVECTION AND AUTOMATIC MIX COOKING

Cuban Flan

Makes 12 servings

Low Mix – Low Rack

Flan

- 4 oz. cream cheese
- 4 whole eggs, large
- 2¹/₂ cups sweetened condense milk
- 2 cups milk

Caramel Sauce

- 2¹/₃ cups granulated sugar
- ¹/₂ teaspoon lemon juice
- ³/₄ cup hot water

1. Place the sugar and the lemon juice into a saucepan. Cook, stirring constantly with a wooden spoon over medium heat. The sugar will start to melt and change its color to a caramel. Continue to cook the sugar till it reaches the desired color.
2. Carefully pour in the hot water very slowly, while continuing to cook, keep stirring. Once dissolved into a syrup, stop the cooking and cool completely. In its cooled state, add additional water as needed to thin to the proper consistency.

Flan Mixture

1. Soften the cream cheese to room temperature. Place into a mixer with a paddle attachment. Add in the eggs one at a time and incorporate till the mixture is smooth. Scrape down the bowl to make sure that all of the cream cheese is mixed evenly with the eggs.
2. Add in slowly the sweetened condense milk and the milk till blended well. Before pouring it into the 8¹/₂ x 4¹/₂-loaf bread pan, strain mixture through a sieve to avoid any lumps from the cream cheese or parts of the egg. Pour caramel sauce on bottom of loaf pan, just to cover. Pour Flan over caramel sauce.
3. Place loaf pan inside of 9 x 13-cake pan.
4. Boil 4 cups of water in the microwave oven.
5. Place Flan loaf inside 9 x 13-cake pan; place on low rack on turntable in microwave oven. Pour hot water into 9 x 13 pan, up to ³/₄ inch from top of pan. Make sure 9 x 13 pan is centered and can turn completely without touching sides of the microwave oven.
6. Press LOW MIX. Press **4 5 0 0** minutes. Close door. Press START. Using a silver knife, place in center of Flan, it should come out clean, and center should be firm and not jiggle. If not done add some extra time, it should be firm.
7. Carefully remove Flan from hot water bath, cool completely, refrigerate. Unmold when cool, run a knife around edges, turn upside down on your serving platter. It should be firm to slice, ³/₄ inch wedges. Place on plate and use the extra caramel sauce to top Flan, serve with fresh fruit or some sprigs of mint.

MANUAL CONVECTION AND AUTOMATIC MIX COOKING

Spicy Mex-Fried Chicken

Makes 4-6 servings

High Mix

- 4 oz. Cheese crackers crumbs, fine
- 2 tablespoons Taco Mix, dry
- 1 egg
- 1 tablespoon water
- 4-6 chicken legs and thighs, or 4-6 Breast or 1 whole cut up chicken

1. Use food processor to process cheese cracker with taco mix. Pour mixture on to plate.
2. Mix egg with 1 tablespoon water in small bowl.
3. Wash chicken, pat dry.
4. Dip chicken pieces into egg wash, then into cracker crumbs, place chicken on lower rack on top of turntable. Place largest pieces of chicken along the edge and smaller piece in the center of rack. Evenly distribute the meat.
5. Press HIGH MIX twice, then 7
375°F, for time press 3 0 0 0 minutes. Correct temperature for thighs and legs is 180°F and chicken breast 170°F for doneness. Check at 25 minutes for temperatures, if not done you still have another 5 minutes on your program left. Close door and continue, if not done. Using an instant read thermometer in each chicken piece is always a good idea. Chicken should always be fully cooked.

This is a tasty meal, while chicken is cooking fix a green salad with vegetables and fruit. Watch this chicken dish disappear fast.

OTHER CONVENIENT FEATURES

MULTIPLE SEQUENCE COOKING

The oven can be programmed for up to 4 automatic cooking sequences for the microwave mode and 2 automatic cooking sequences with preheat for convection/mix mode, switching from one power level setting to another automatically.

Sometimes cooking directions tell you to start on one power level and then change to a different power level. Your oven can do this automatically.

- Suppose you want to cook roast beef for 5 minutes at 100% and then continue to cook for 30 minutes at 50%:
 1. First touch POWER LEVEL pad twice for 100% power. Then enter cooking time.
 2. Touch POWER LEVEL pad. Touch number pad **5** for 50% power. Then enter second cooking time.
 3. Touch START pad.

Note:

1. If POWER LEVEL pad is touched twice, HIGH will be displayed.
2. If you wish to know power level, simply touch the POWER LEVEL pad. As long as your finger is touching the POWER LEVEL pad, the power level will be displayed.

MORE OR LESS TIME ADJUSTMENT

Should you discover that you like any of the SENSOR, SENSOR COOK, DEFROST, AUTO BROIL, AUTO ROAST or AUTO BAKE settings slightly more done, touch the POWER LEVEL pad once after touching your choice of pads.

Should you discover that you like any of the SENSOR, SENSOR COOK, DEFROST, AUTO BROIL, AUTO ROAST or AUTO BAKE settings slightly less done, touch the POWER LEVEL pad twice after touching your choice of pads.

EXTRA MINUTE

EXTRA MINUTE allows you to cook for a minute at 100% by simply touching the EXTRA MINUTE pad. You can also extend cooking time in multiples of 1 minute by repeatedly touching the EXTRA MINUTE pad during manual cooking.

- Suppose you want to heat a cup of soup for one minute.

Touch EXTRA MINUTE pad.

Note:

1. To use EXTRA MINUTE, touch pad within 1 minute after cooking, closing the door, touching the Stop/Clear pad or during cooking.
2. EXTRA MINUTE cannot be used with SENSOR, SENSOR COOK, DEFROST, AUTO BROIL, AUTO ROAST or AUTO BAKE.

HELP MENU

HELP MENU provides 5 features which make using your microwave oven easy because specific instructions are provided in the interactive display.

1. Safety Lock

The Safety Lock prevents unwanted microwave oven operation such as by small children.

The microwave oven can be set so that the control panel is deactivated or locked. To set, touch HELP MENU, the number **1** and START pads. Should a pad be touched, LOCK will appear in the display.

To cancel, touch HELP MENU and STOP/CLEAR pads.

OTHER CONVENIENT FEATURES

2. Audible Signal Elimination

If you wish to have the microwave oven operate with no audible signals, touch HELP MENU, the number **2** and STOP/CLEAR pads.

To cancel and restore the audible signal, touch HELP MENU, the number **2** and START pads.

3. Auto Start

If you wish to program your microwave oven to begin cooking automatically at a designated time of day, follow this procedure:

- Suppose you want to start cooking a stew on 50% for 20 minutes at 4:30. Before setting, check to make sure the clock is showing the correct time of day.
1. Touch HELP MENU pad.
 2. Touch number **3** to select the Auto Start.
 3. To enter the start time at 4:30, touch numbers **4**, **3** and **0**.
 4. Touch CLOCK pad.
 5. To enter cooking program, touch POWER LEVEL, number **5** and then touch numbers **2**, **0**, **0**, and **0** for cooking time.
 6. Touch START pad. The chosen Auto Start time will appear in the display.

Note:

1. *Auto Start can be used for manual cooking, AUTO BROIL, AUTO ROAST, AUTO BAKE, if clock is set.*
2. *If the microwave oven door is opened after programming Auto Start, it is necessary to touch the START pad for Auto Start time to appear in the readout so that the microwave oven will automatically begin programmed cooking at the chosen Auto Start time.*
3. *Be sure to choose foods that can be left in the microwave oven safely until the Auto Start time. Acorn or butternut squash are often a good choice.*
4. *If you wish to know the time of day, simply touch the CLOCK pad. As long as your finger is touching the CLOCK pad, the time of day will be displayed.*

4. Language Selection

The microwave oven comes set for English. To change, touch HELP MENU and the number **4** pads. Continue to touch the number **4** pad until your choice is selected. Then, touch START pad.

Touch number **4** once for English.

Touch number **4** twice for Spanish.

Touch number **4** three times for French.

5. Weight and Temperature Selections

The microwave oven comes set for U.S. Customary Unit-pounds. To change, touch HELP MENU and the number **5**. Continue to touch the number **5** until your choice is selected. Then, touch START pad.

Touch number **5** once for LB / °F.

Touch number **5** twice for KG / °C.

OTHER CONVENIENT FEATURES

KITCHEN TIMER

- Suppose you want to time a 3 minute long distance phone call.

1. Touch KITCHEN TIMER pad.
2. Enter time by touching the number pads **3** **0** **0**.
3. Touch START pad.

START

START allows you to cook at 100% power by touching the START pad continuously. START is ideal for melting cheese, bringing milk to just below boiling etc.

The maximum cooking time is 3 minutes.

- Suppose you want to melt cheese on a piece of toast:
 1. Continuously touch the START pad. The cooking time will begin counting up.
 2. When the cheese is melted to desired degree, remove finger from START pad. Microwave oven stops immediately.

Note:

1. *Note time it takes for frequently used foods and program that time in the future.*
2. *To use START, touch pad within 1 minute after cooking, opening and closing the door or touching the STOP/CLEAR pad.*
3. *START can only be used 3 times in a row. If more times are needed, open and close door or touch STOP/CLEAR.*

HELP (DISPLAY INDICATOR)

Each setting of DEFROST, AUTO BROIL, AUTO ROAST, AUTO BAKE, SENSOR COOK and SENSOR has a cooking hint. If you wish to check, touch HELP MENU pad whenever HELP is lighted in the Interactive Display for these hints.

DEMONSTRATION MODE

To demonstrate, touch CLOCK, the number **0** and then touch START pad and hold for 3 seconds. DEMO ON will appear in the display. Cooking operations and specific special features can now be demonstrated with no power in the microwave oven. For example, touch EXTRA MINUTE pad and the display will show 1.00 and count down quickly to END.

To cancel, touch CLOCK, then the number **0** and STOP/CLEAR pads. If easier, unplug the microwave oven from the electrical outlet and replug.

CLEANING AND CARE

Disconnect the power cord before cleaning or leave the door open to inactivate the microwave oven during cleaning.

Exterior

The outside surface is painted. Clean the outside with mild soap and water; rinse and dry with a soft cloth. Do not use any type of household or abrasive cleaner.

Door

Wipe the window on both sides with a damp cloth to remove any spills or spatters. Metal parts will be easier to maintain if wiped frequently with a damp cloth. Avoid the use of spray and other harsh cleaners as they may stain, streak or dull the door surface.

Touch Control Panel

Care should be taken in cleaning the touch control panel. If the control panel becomes soiled, open the microwave oven door before cleaning. Wipe the panel with a cloth dampened slightly with water only. Dry with a soft cloth. Do not scrub or use any sort of chemical cleaners. Close door and touch STOP/CLEAR pad.

Interior – after microwave cooking

Cleaning is easy because little heat is generated to the interior surfaces; therefore, there is no baking and setting of spills or spattering. To clean the interior surfaces, wipe with a soft cloth and warm water. DO NOT USE ABRASIVE OR HARSH CLEANERS OR SCOURING PADS. For heavier soil, use baking soda or a mild soap; rinse thoroughly with hot water. NEVER SPRAY OVEN CLEANERS DIRECTLY ONTO ANY PART OF THE MICROWAVE OVEN.

Interior – after convection, mix or broil cooking

Spatters may occur because of moisture and grease. Wash immediately after use with hot, soapy water. Rinse and polish dry. Harder to remove spatters may occur if oven is not thoroughly cleaned or if there is long time/high temperature cooking. If so, you may wish to purchase an oven cleaner pad with liquid cleaner within it—not a soap filled steel pad—for use on stainless or porcelain surfaces. Follow manufacturer's directions carefully and be especially cautious not to get any of the liquid cleaner in the perforations on the wall or ceiling or any door surfaces. Rinse thoroughly and polish dry.

After cleaning the interior thoroughly, residual grease may be removed from the interior ducts and heater by simply operating the oven on 450°F for 20 minutes without food. Ventilate the room if necessary.

Waveguide Cover

The waveguide cover is made from mica so requires special care. Keep the waveguide cover clean to assure good microwave oven performance. Carefully wipe with a damp cloth any food spatters from the surface of the cover immediately after they occur. Built-up splashes may overheat and cause smoke or possibly catch fire. Do not remove the waveguide cover.

Odor Removal

Occasionally, a cooking odor may remain in the microwave oven. To remove, combine 1 cup water, grated peel and juice of 1 lemon and several whole cloves in a 2-cup glass measuring cup. Boil for several minutes using 100% power. Allow to set in microwave oven until cool. Wipe interior with a soft cloth.

Turntable/Turntable Support/Racks

The turntable, turntable support and racks can be removed for easy cleaning. Wash them in mild, sudsy water; for stubborn stains use a mild cleanser and a non-abrasive scouring sponge. They are also dishwasher-proof. Use top rack of dishwasher for turntable support.

Foods with high acidity, such as tomatoes or lemons, will cause the turntable to discolor. Do not cook highly acidic foods directly on the turntable; if spills occur, wipe up immediately.

The turntable motor shaft is not sealed, so excess water or spills should not be allowed to stand in this area.

SPECIFICATIONS

AC Line Voltage:	UL Rating - Single phase 120V, 60Hz, AC only CSA Rating - Single phase 117V, 60Hz, AC only
AC Power Required:	UL Rating - Microwave 1.55 kw, 13.0 amps. UL Rating - Convection 1.55 kw, 13.0 amps. CSA Rating - Microwave 1.5 kw, 13.0 amps. CSA Rating - Convection 1.5 kw, 13.0 amps.
Output Power:	
Microwave*	900 watts
Convection Heater	1450 watts
Frequency:	2450 MHz
Outside Dimensions:	24 5/8"(W) x 14 7/8"(H) x 19"(D)
Cavity Dimensions:	16 1/8"(W) x 9 5/8"(H) x 16 1/8"(D)
Microwave oven Capacity:**	1.5 Cu. Ft.
Cooking Uniformity:	Turntable system, diameter 15 3/8"
Weight:	Approx. 60 lb

* The International Electrotechnical Commission's standardized method for measuring output wattage. This test method is widely recognized.

** Internal capacity is calculated by measuring maximum width, depth and height. Actual capacity for holding food is less.

In compliance with standards set by:

FCC – Federal Communications Commission Authorized.

DHHS – Complies with Department of Health and Human Services (DHHS) rule, CFR, Title 21, Chapter I, Subchapter J.

 – This symbol on the nameplate means the product is listed by Underwriters Laboratories, Inc. for use in USA or Canada.

NHW – Department of National Health and Welfare of Canada.

This microwave oven is listed by the Canadian Standard Association as certified.

SERVICE CALL CHECK

Check the following before calling for service:

1. Place one cup of water in a glass measuring cup in the microwave oven and close the door securely.

Operate the microwave oven for one minute at HIGH 100%.

- A. Does the microwave oven light come on? YES _____ NO _____
- B. Does the cooling fan work? YES _____ NO _____
(Put your hand over the rear ventilating openings.)
- C. Does the turntable rotate? YES _____ NO _____
(It is normal for the turntable to turn in either direction.)
- D. Is the water in the microwave oven warm? YES _____ NO _____

2. Remove water from the oven and operate the oven for 5 minutes at AUTO 450°F.

Operate the microwave oven for one minute at HIGH 100%.

- A. Do CONV and COOK indicators light? YES _____ NO _____
- B. After the oven shuts off, is inside of the microwave oven hot? YES _____ NO _____

If 'NO' is the answer to any of the above questions, please check electrical outlet, fuse and/or circuit breaker. If they are functioning properly, contact Customer Care. For contact details, see your Service & Warranty booklet or visit our local website listed on the back cover.

A microwave oven should never be serviced by a 'do-it-yourself' repair person.

Note: If time appearing in the display is counting down very rapidly, check Demonstration Mode on page 50 and cancel.

WARRANTY

See your Service & Warranty booklet for warranty details.

FISHERPAYKEL.COM

© Fisher & Paykel Appliances 2021. All rights reserved.

The models shown in this guide may not be available in all markets
and are subject to change at any time.

The product specifications in this guide apply to the specific products and
models described at the date of issue. Under our policy of continuous product
improvement, these specifications may change at any time.

For current details about model and specification availability in your country,
please go to our website or contact your local Fisher & Paykel dealer.

© Fisher & Paykel Appliances 2021. Tous droits réservés.

Les modèles illustrés dans ce guide peuvent ne pas être disponibles
dans tous les pays et sont sujets à modifications sans préavis.

Les caractéristiques de produit présentées dans ce guide s'appliquent aux
modèles et produits spécifiques qui y sont décrits à la date de publication.

Dans le cadre de notre politique d'amélioration en permanence de nos produits,
ces caractéristiques peuvent être modifiées à tout moment.

Pour les plus récentes informations sur la disponibilité des modèles
et des caractéristiques dans votre pays, veuillez visiter notre site Web ou
contacter votre détaillant Fisher & Paykel local.