

# Top Loader Washing Machine, 7kg

Series 5 | Top Load

White



Running on SmartDrive™ technology for a quicker, quieter wash, you'll have plenty of room for a generous wash load.

- Six wash cycles including Allergy, Quick, Wool and Delicate
- Soak wash feature helps to clean tough stains
- Soft-close lid avoids slamming and hands-free operation
- Fast 1000RPM spin speed to remove more water for quicker drying

## DIMENSIONS

Height	1045 - 1075mm
Width	600mm
Depth	600mm

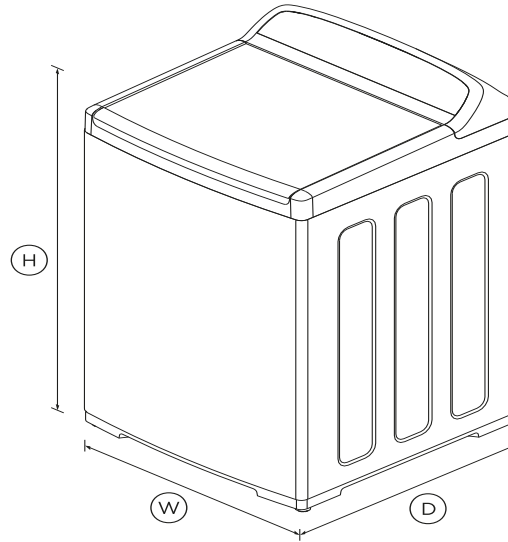

## FEATURES & BENEFITS

### Easy to use

This machine has a cycle to suit every type of load including Delicate, Allergy and Wool. Select a cycle with easy-to-use SmartTouch™ controls.

### Cares for clothes

This machine has a cycle to suit every type of load including Delicate, Allergy and Wool. Select a cycle with easy-to-use SmartTouch™ controls.

### Soft Close Lid

The robust plastic lid has a soft close mechanism that makes it family safe, avoids slamming and allows for hands-free operation.

### Easy installation

Self-levelling feet make installation easy and ensure the washer stays level. This minimises out-of-balance issues and vibration, which keeps noise levels to a minimum.

## SPECIFICATIONS

### Consumption

Energy rating	2 star
Energy usage	565kWh/year
In-use energy carbon	368.0kgCO2e/year
Water consumption per cycle	86L
Water efficiency	3.5 star (WELS)

### Features

Adjustable alert beeps	•
Agitator	Flexible finned
Auto out of balance correction	•
Automatic water level	•
Child/Keylock	•
Controlled cold	•
Delay start	•
Detergent dispenser	•
Eco rinse	•
Fabric softener dispenser	•
Lid lock	•
Manual water levels	5
No spin / Spin Hold	•
Rinse options	3
Soak	•
Spin speeds	3

Stainless steel drum	•
Water temperature controls	5

SKU 92261

**Performance**

Auto-Lint disposal	•
Load sensing	•
Maximum spin speed	<b>1000rpm</b>
Number of spin speeds	<b>3</b>
SmartDrive™ technology	•

The product dimensions and specifications in this page apply to the specific product and model. Under our policy of continuous improvement, these dimensions and specifications may change at any time. You should therefore check with Fisher & Paykel's Customer Care Centre to ensure this page correctly describes the model currently available. ? Fisher & Paykel Appliances Ltd 2020

**Product dimensions**

Depth	<b>600mm</b>
Height	<b>1045 - 1075mm</b>
Height (Lid open)	<b>1350 - 1380mm</b>
Width	<b>600mm</b>

**Warranty**

Parts and labour	<b>2 years</b>
Parts only SmartDrive™ Motor	<b>10 years</b>

**Wash Cycles**

Allergy	•
Customise cycle	•
Delicate	•
Heavy	•
Number of wash cycles	<b>6</b>
Quick	•
Regular	•
Wool	•

**Other product downloads available at fisherpaykel.com**

- [↓](#) User Guide
- [↓](#) Service & Warranty
- [↓](#) Energy & Water Label
- [↓](#) Installation Guide



**A PEACE OF MIND SALE**

**24 Hours 7 Days a Week Customer Support**

**T 1300 650 590 Wwww.fisherpaykel.com**