

13.5 cu ft Series 5 Refrigerator Freezer

Contemporary

With generous storage and stylish stainless steel design with concealed handles for a more streamlined look.

- ActiveSmart™ helps keep food fresher for longer
- Ultra flat door conceals handles for a streamlined look
- Bottom freezer

DIMENSIONS

Height	67 3/4 "
Width	25 "
Depth	27 3/8 "

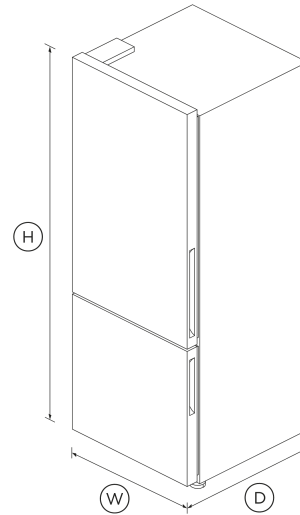

FEATURES & BENEFITS

Activesmart™ Foodcare

ActiveSmart™ Foodcare learns how you live. It's technology which understands how you use your refrigerator and adjusts temperature, airflow and humidity inside to help keep food fresher for longer.

Easy Cleaning

No more permanent dirty marks with our EZKleen feature for stainless steel refrigerators. Anti-fingerprint coating means you simply wipe clean any marks. Spill-safe secure glass shelves easily capture any drips or leaks.

Humidity Control

Your fruit and veges need different environments. The humidity control slides in each storage bin create a microclimate that helps keep food fresher for longer.

Design Quality

Our refrigerators are designed and built using quality materials. We use real stainless steel on our refrigerators and solid glass for shelving.

Clever Energy

Your refrigerator adapts to daily use by cooling and defrosting only when needed. This means your refrigerator uses the energy it needs without compromising on food care.

SPECIFICATIONS

Capacity

Total gross capacity	13.5 cu ft
Volume freezer	4 cu ft
Volume refrigerator	9.5 cu ft

Connected Features

- Alerts and notifications
- Education and onboarding
- Remote operation
- Software updates

Consumption

Energy rating	Energy Star
Energy usage	461kWh/year
In-use energy carbon emissions estimate	53.2kgCO2e/year

Features

Adjustable door shelves	7
Adjustable glass shelves	4

Covered door shelves	2	Depth	27 3/8 "
Door alarm	•	Height	67 3/4 "
Front levelling feet	•	Minimum air clearance at rear	1 3/16 "
Fruit and vegetable bins	2	Minimum air clearance each side	1 3/16 "
Full extension runners	•	Minimum air clearance on top	2 "
LED lighting	•	Width	25 "
Rear rollers	•		
Smart appliance	•		
Spill proof removable bins	•		
Stackable bottle holders	2		

Variable Temp Compartment

Bottle chill mode	•
-------------------	---

SKU	26276
-----	-------

The product dimensions and specifications in this page apply to the specific product and model. Under our policy of continuous improvement, these dimensions and specifications may change at any time. You should therefore check with Fisher & Paykel's Customer Care Centre to ensure this page correctly describes the model currently available. © Fisher & Paykel Appliances Ltd 2020

Other product downloads available at fisherpaykel.com

- [↓](#) DWG
- [↓](#) DXF
- [↓](#) Data Sheet (English)
- [↓](#) Energy Label
- [↓](#) Water Filter Replacement Instructions - Parts 847200 and 847201 (English)
- [↓](#) Installation Guide (English)
- [↓](#) Installation Guide (English)
- [↓](#) Water Filter Replacement Instructions - Parts 847200 and 847201 (French)

- [↓](#) Installation Guide - Joiner Kit (Canadian French)
- [↓](#) Installation Guide (Canadian French)
- [↓](#) Right To Repair Declaration (English, Canadian French)
- [↓](#) User Guide (English)
- [↓](#) User Guide (Canadian French)

Where applicable:

All appliances use energy, and energy usage typically generates carbon emissions. **Fisher & Paykel Appliances' In-use Energy Carbon Emissions Estimate** indicates carbon emissions from a product's in-use energy. This is calculated either annually or per cycle, using the product's market-specific energy label energy consumption data multiplied by the carbon emissions factor for energy in your country or region.

Our In-use Energy Carbon Emissions Estimate is designed to assist customers in making informed purchasing decisions when comparing different Fisher & Paykel products. For example, a heat pump dryer typically has a lower In-use Energy Carbon Emissions Estimate than a vented dryer.



A PEACE OF MIND SALE
24 Hours 7 Days a Week Customer Support
 T 1.888.936.7872 W www.fisherpaykel.com

Freezer Features

- Bottle chill •
- Fast freeze •
- Large plastic bins •

Performance

- ActiveSmart™ Foodcare •
- Adaptive defrost •
- Frost free •
- Sabbath mode •

Power requirements

Rated current	10 A
Supply frequency	60 Hz
Supply voltage	115 V

Product dimensions