

# FISHER & PAYKEL

## PRELIMINARY SPECIFICATION GUIDE

## OVEN, 24"



### OVERVIEW

Designed to fit seamlessly into any kitchen with Minimal styling, this 24" oven features a generous 3 cu ft total capacity. Achieve perfect results with 16 oven functions, plus a Wireless Temperature Sensor\* for monitoring cooking in real time. Beautiful to use, the large 5" touchscreen interface features simple and intuitive guided cooking, while Pyrolytic self-cleaning breaks down grime and grease, to keep the oven pristine for the next use.

\*Selected markets and models

### MODELS

#### Oven, 24", 16 Function

3 cu ft, Self-cleaning, Touchscreen, Dial  
OB24SMPTDB1

### SERIES & STYLE

Series 9  
Minimal

### ACCESSORIES

- 1 Large perforated pan
- 2 Small perforated dish
- 3 Large unperforated dish
- 4 Baking tray
- 5 Roasting dish

### FEATURES

- 1 Minimal style, designed to fit flush with cabinetry
- 2 Generous 3 cu ft total capacity with six shelf positions
- 3 Intuitive, large 5" touchscreen display with illuminated dial
- 4 16 oven functions including Air fry, Fan Bake, and Roast
- 5 Pyrolytic self-cleaning function breaks down food residue for an easy clean
- 6 Wireless Temperature Sensor precisely monitors cooking in real time\*
- 7 Guided touchscreen cooking makes it simple to cook by food, function or recipe
- 8 Moisture control and even heat distribution thanks to ActiveVent and AeroTech™ technology
- 9 Automatic rapid pre-heat function for added convenience
- 10 Soft open and close door
- 11 Wi-Fi/Connected capability through the SmartHQ™ app\*

\*Selected markets and models

- 6 Grill grid
- 7 Grill rack
- 8 Step down wire shelf
- 9 Full extension wire shelves
- 10 Wireless Temperature Sensor\*

\*Selected markets and models

# FISHER & PAYKEL

## PRELIMINARY SPECIFICATION GUIDE

OVEN, 24"

### SPECIFICATIONS

Model No.	OB24SMPTDB1
Dimensions	<b>H</b> 23 9/16" (598mm) x <b>W</b> 23 7/16" (596mm) x <b>D</b> 22 1/4" (565mm)
Total capacity	3 cu ft (85L)
Weight	70 lbs (32kg) unpackaged 97 lbs (44kg) packaged
Electrical	
Supply	208-240V, 60Hz
Service	16.6 - 19.4 A circuit

### PRODUCT DIMENSIONS

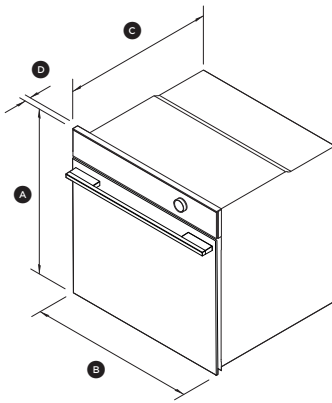

ISO VIEW

		in	mm
(A)	Overall height	23 9/16	598
(B)	Overall width	23 7/16	596
(C)	Depth of chassis	21 7/16	545
(D)	Depth from front of chassis to front of oven door (excl.dial & handle)	13/16	20
	Depth of oven door when fully open (measured from front of control panel)	18 1/8	460

### CAVITY DIMENSIONS

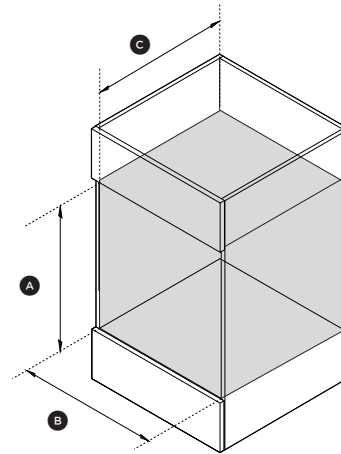

ISO VIEW

		in	mm
(A)	Minimum inside height of cavity	22 7/8	580
(B)	Minimum inside width of cavity	22 1/16	560
(C)	Minimum inside depth of cavity	21 11/16	550