

# Induction Range, 30", 4 Zones with SmartZone, Self-cleaning

Series 9 | Professional

Stainless Steel



With intuitive touchscreen, induction cooktop and a convection oven with 15 functions, cooking on this refined range is a joy.

- Guided cooking using your touchscreen makes it simple to cook by food, function or recipe.
- Ability to pair two of the four induction cook zones to create a large SmartZone
- 4 cu ft total oven capacity
- Beautiful LED halo-illuminated dials provide information at a glance

## DIMENSIONS

Height	35 3/4" - 36 3/4"
Width	29 7/8"
Depth	29 1/8"

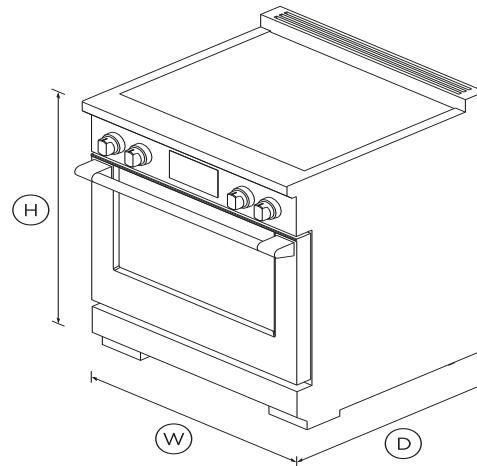

## FEATURES & BENEFITS

### COOK WITH CONFIDENCE

Our touchscreen interface provides an intuitive guided cooking experience that helps deliver perfect results, whether you've been cooking all your life or just starting out. Cook with a favorite method, a hero ingredient, or a go-to cooking function or recipe. The screen tilts for improved ergonomics and optimal visibility while cooking.

### GENEROUS CAPACITY

Featuring a generous total capacity of 4 cu ft, with enough room

to fit a 26 lb turkey, or to cook several dishes at once.

### COOKTOP POWER

Instant and immediate control from the highest to the gentlest heat. The finely tuned cooktop controls let you sear, stir fry or simmer to perfection. Since most of the heat generated by the cooktop is transferred into cookware, induction offers an energy-efficient cooking option.

### COOKING FLEXIBILITY

No matter what you're cooking, you've got the right heat to get perfect results. Each of the 15 oven functions have been extensively researched and carefully designed to cater to a broad range of dishes and cooking styles. The handy food probe helps you monitor your progress.

### DESIGN QUALITY

This range has craftsmanship in every detail, with real stainless steel, high-quality glass, and beautifully weighted, halo illuminated dials. Each cavity features incandescent lights and full extension telescopic racks. From the robust legs to the powerful cooktop, this Range is built to last.

### EASY TO CLEAN

The oven features a self-cleaning function and self-clean proof side racks, which don't need to be removed when using this function. The durable induction cooktop surface only needs a quick wipe after use to keep it clean.

## SPECIFICATIONS

### Accessories

Adjustable feet covers	•
Branded coin end cap	•
Square handle option	<b>AH-R30</b>

### Capacity

Shelf positions	<b>5</b>
-----------------	----------

---

**Cleaning**

- Pyrolytic self-clean •

---

**Controls**

- Electric circuit **4 wire**
- High resolution display •
- Metal illuminated dials •
- Multi-language interface •
- Recipe and food based •
- Sabbath mode •
- Tilting touch screen interface •
- Wi-Fi connectivity •

---

**Oven features**

- Broil pan •
- Concealed element •
- Electronic oven control •
- Food probe •
- Full extension telescopic •
- Internal light •
- Self-clean proof side racks •
- True convection •

---

**Oven functions**

- Air fry •
- Bake •
- Classic bake •
- Clean •
- Convection Broil •

- Convection bake •
- Dehydrate •
- Maxi Broil •
- Number of functions **15**
- Pastry bake •
- Pizza bake •
- Rapid proof •
- Roast •
- Slow cook •
- True convection •
- Warm •

---

**Oven performance**

- Bake power **3500**
- Main oven - True convection **2500W**

---

**Power requirements**

- Rated current **50A**
- Supply frequency **60Hz**

---

**Product dimensions**

- Depth **29 1/8"**
- Height **35 3/4 - 36 3/4"**
- Width **29 7/8"**

---

**Rangetop features**

- Gentle heat •
- Heat settings **9**
- Induction cooking technology •
- SmartZone **1**

- Zone bridging •

---

**Rangetop Performance**

- Left front zone rating **1400 (2200)W**
- Left rear zone rating **2600 (3700)W**
- Number of cooking zones **4**
- PowerBoost •
- Right front zone rating **2100 (3700)W**
- Right rear zone rating **2100 (3700)W**

---

**Recommended Back Guards Ventilation**

- Combustible situation **BGRV3-3030H**
- Non combustible situation **BGRV2-3030 / BGRV2-1230**
- Recommended hood **HCB30-6\_N (Professional)**

---

**Safety**

- ADA compliant •
- Pan detection system •
- Safety time out •
- Surface hot indicators •

---

**Warranty**

- Parts and labor **Limited 2 years**

---

- SKU **81893**









---

The product dimensions and specifications in this page apply to the specific product and model. Under our policy of continuous improvement, these dimensions and specifications may change at any time. You should therefore check with Fisher &

Paykel's Customer Care Centre to ensure this page correctly describes the model currently available. ? Fisher & Paykel Appliances Ltd 2020

---

**Other product downloads available at fisherpaykel.com**

-  [Service & Warranty](#)
-  [User Guide Professional Range](#)
-  [Installation Guide](#)
-  [Specification Guide](#)
-  [Data Sheet Induction Cooker](#)
-  [Data Sheet Induction Cooker](#)
-  [Data Sheet Induction Range](#)
-  [Planning Guide](#)



**A PEACE OF MIND SALE**

**24 Hours 7 Days a Week Customer Support**

**T 1.888.936.7872 W [www.fisherpaykel.com](http://www.fisherpaykel.com)**